

Преобразователь сигналов SINEAX VS46

Архангельск (8182)63-90-72
Астана (7172)727-132
Астрахань (8512)99-46-04
Барнаул (3852)73-04-60
Белгород (4722)40-23-64
Брянск (4832)59-03-52
Владивосток (423)249-28-31
Волгоград (844)278-03-48
Вологда (8172)26-41-59
Воронеж (473)204-51-73
Екатеринбург (343)384-55-89
Иваново (4932)77-34-06
Ижевск (3412)26-03-58
Казань (843)206-01-48

Калининград (4012)72-03-81
Калуга (4842)92-23-67
Кемерово (3842)65-04-62
Киров (8332)68-02-04
Краснодар (861)203-40-90
Красноярск (391)204-63-61
Курск (4712)77-13-04
Липецк (4742)52-20-81
Магнитогорск (3519)55-03-13
Москва (495)268-04-70
Мурманск (8152)59-64-93
Набережные Челны (8552)20-53-41
Нижний Новгород (831)429-08-12
Новокузнецк (3843)20-46-81

Новосибирск (383)227-86-73
Омск (3812)21-46-40
Орел (4862)44-53-42
Оренбург (3532)37-68-04
Пенза (8412)22-31-16
Пермь (342)205-81-47
Ростов-на-Дону (863)308-18-15
Рязань (4912)46-61-64
Самара (846)206-03-16
Санкт-Петербург (812)309-46-40
Саратов (845)249-38-78
Севастополь (8692)22-31-93
Симферополь (3652)67-13-56
Смоленск (4812)29-41-54

Сочи (862)225-72-31
Ставрополь (8652)20-65-13
Сургут (3462)77-98-35
Тверь (4822)63-31-35
Томск (3822)98-41-53
Тула (4872)74-02-29
Тюмень (3452)66-21-18
Ульяновск (8422)24-23-59
Уфа (347)229-48-12
Хабаровск (4212)92-98-04
Челябинск (351)202-03-61
Череповец (8202)49-02-64
Ярославль (4852)69-52-93

Единый адрес для всех регионов: cmn@nt-rt.ru || www.camille-bauer.nt-rt.ru

использовано с разрешения официального дистрибьютора
АО «ЮЕ-Интернейшнл»

SINEAX VS46

Signal Converter

Thermocouple converter



Features / Benefits

- Input: Thermocouples types: J, K, E, N, S, R, B, T
- Output: Current 0/4 ... 20, 20 ... 4/0 mA or voltage 0 ... 5/10, 10 ... 0 and 1 ... 5 V DC
solid state relay (SSR) for thermostat / alarm function
- 3-way galvanic isolation
- Spring-cage clamp connection
- Power bridging terminal – DIN rail bus connector
- Small dimensions (6.2 x 93.1 x 102.5 mm)
- Resolution of 14 bit
- Accuracy class 0.1%

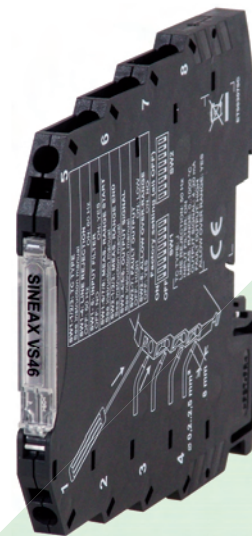

General Data

| | |
|---------------------------|--|
| Power supply | 19.2 ... 30 V DC |
| Accuracy | Class: 0.1% Cold junction error: 1.5 °C max. |
| Status indicators (LED) | Fault State of the auxiliary output |
| Galvanic isolation | Power supply / input / output at 1500 V AC, digital |
| Hot swapping | Yes |
| Power consumption | 500 mW |
| A/D Converter | 14 bit |
| Current output protection | Approximately 25 mA |
| Security output | 102.5% of full scale value in case of over-range 105% of full scale value in case of improper functioning |
| Humidity | Up to 90% at + 40 °C (not condensing) |
| Housing | Terminal housing for mounting on 35 mm DIN 46277 |
| Frequency filter | 50 ... 60 Hz (settable) |
| DIP-Switch | – Input signals setup – Output signal setup |
| Processing | Floating point 32 bit |
| Dimensions | 6,2 x 93,1 x 102,5 mm (w x h x d) |
| Weight | 50 g |
| Operating temperature | – 20 ... + 65 °C |

| | |
|---------------|-------------------|
| Connections | Spring cage clamp |
| IP Protection | IP 20 |
| Conformity | CE |

Input Data

| | |
|---------------|--|
| Thermocouples | Types J, K, E, N, S, R, B, T Lower span: 100 °C Impedance: 10 MΩ |
|---------------|--|

Output Data

| | |
|--------------|---|
| Current: | 0 ... 20 mA, 4 ... 20 mA, 20 ... 0 mA and 20 ... 4 mA Higher load resistance: 500 Ω |
| Voltage | 0 ... 5 V DC, 1 ... 5 V DC, 0 ... 10 V DC and 10 ... 0 V DC Lower load resistance: 2 kΩ |
| Relay output | Applicable voltage 24 V AC nominal Current: 60 mA max. |

SINEAX VS46

Signal Converter

Order Codes

| Description | Code |
|--|---------|
| Thermocouple converter | 162 777 |
| Accessories | |
| CB-Power-Bus Expandable power supply connector | 162 826 |
| SINEAX VS70 Power supply module with surge protection | 162 818 |

Installation

Inserting / Extracting module on DIN guide



Expandable connector CB-Power-Bus

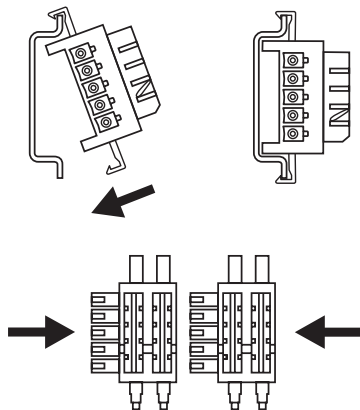

Spring cage clamp connection

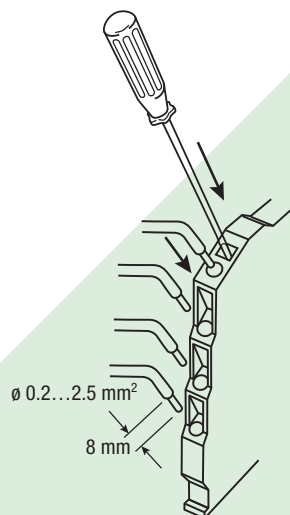

Electrical connections

Power supply

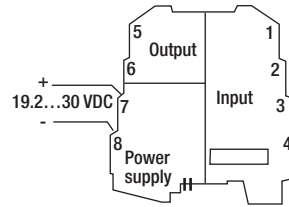

Input

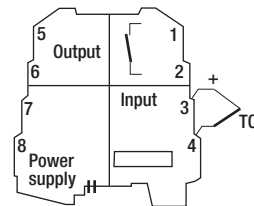

Output

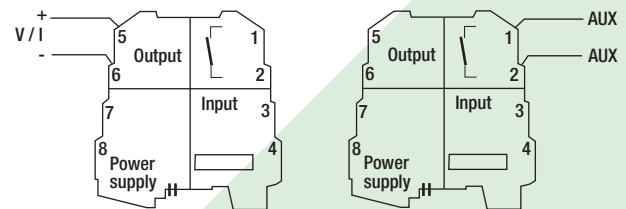

Dimensional drawing

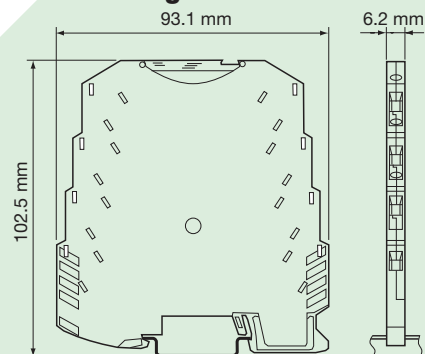

CAMILLE BAUER
Rely on us.

По вопросам продажи и поддержки обращайтесь:

Архангельск (8182)63-90-72
Астана (7172)727-132
Астрахань (8512)99-46-04
Барнаул (3852)73-04-60
Белгород (4722)40-23-64
Брянск (4832)59-03-52
Владивосток (423)249-28-31
Волгоград (844)278-03-48
Вологда (8172)26-41-59
Воронеж (473)204-51-73
Екатеринбург (343)384-55-89
Иваново (4932)77-34-06
Ижевск (3412)26-03-58
Казань (843)206-01-48



Калининград (4012)72-03-81
Калуга (4842)92-23-67
Кемерово (3842)65-04-62
Киров (8332)68-02-04
Краснодар (861)203-40-90
Красноярск (391)204-63-61
Курск (4712)77-13-04
Липецк (4742)52-20-81
Магнитогорск (3519)55-03-13
Москва (495)268-04-70
Мурманск (8152)59-64-93
Набережные Челны (8552)20-53-41
Нижний Новгород (831)429-08-12
Новокузнецк (3843)20-46-81

Новосибирск (383)227-86-73
Омск (3812)21-46-40
Орел (4862)44-53-42
Оренбург (3532)37-68-04
Пенза (8412)22-31-16
Пермь (342)205-81-47
Ростов-на-Дону (863)308-18-15
Рязань (4912)46-61-64
Самара (846)206-03-16
Санкт-Петербург (812)309-46-40
Саратов (845)249-38-78
Севастополь (8692)22-31-93
Симферополь (3652)67-13-56
Смоленск (4812)29-41-54



Сочи (862)225-72-31
Ставрополь (8652)20-65-13
Сургут (3462)77-98-35
Тверь (4822)63-31-35
Томск (3822)98-41-53
Тула (4872)74-02-29
Тюмень (3452)66-21-18
Ульяновск (8422)24-23-59
Уфа (347)229-48-12
Хабаровск (4212)92-98-04
Челябинск (351)202-03-61
Череповец (8202)49-02-64
Ярославль (4852)69-52-93

Единый адрес для всех регионов: cmn@nt-rt.ru || www.camille-bauer.nt-rt.ru

PROCESS CONTROL ENGINEERING

ANGULAR POSITION ENGINEERING

HEAVY CURRENT ENGINEERING

