

Источник питания SINEAX VS70

Архангельск (8182)63-90-72
Астана (7172)727-132
Астрахань (8512)99-46-04
Барнаул (3852)73-04-60
Белгород (4722)40-23-64
Брянск (4832)59-03-52
Владивосток (423)249-28-31
Волгоград (844)278-03-48
Вологда (8172)26-41-59
Воронеж (473)204-51-73
Екатеринбург (343)384-55-89
Иваново (4932)77-34-06
Ижевск (3412)26-03-58
Казань (843)206-01-48

Калининград (4012)72-03-81
Калуга (4842)92-23-67
Кемерово (3842)65-04-62
Киров (8332)68-02-04
Краснодар (861)203-40-90
Красноярск (391)204-63-61
Курск (4712)77-13-04
Липецк (4742)52-20-81
Магнитогорск (3519)55-03-13
Москва (495)268-04-70
Мурманск (8152)59-64-93
Набережные Челны (8552)20-53-41
Нижний Новгород (831)429-08-12
Новокузнецк (3843)20-46-81

Новосибирск (383)227-86-73
Омск (3812)21-46-40
Орел (4862)44-53-42
Оренбург (3532)37-68-04
Пенза (8412)22-31-16
Пермь (342)205-81-47
Ростов-на-Дону (863)308-18-15
Рязань (4912)46-61-64
Самара (846)206-03-16
Санкт-Петербург (812)309-46-40
Саратов (845)249-38-78
Севастополь (8692)22-31-93
Симферополь (3652)67-13-56
Смоленск (4812)29-41-54

Сочи (862)225-72-31
Ставрополь (8652)20-65-13
Сургут (3462)77-98-35
Тверь (4822)63-31-35
Томск (3822)98-41-53
Тула (4872)74-02-29
Тюмень (3452)66-21-18
Ульяновск (8422)24-23-59
Уфа (347)229-48-12
Хабаровск (4212)92-98-04
Челябинск (351)202-03-61
Череповец (8202)49-02-64
Ярославль (4852)69-52-93

Единый адрес для всех регионов: cmn@nt-rt.ru || www.camille-bauer.nt-rt.ru

использовано с разрешения официального
дистрибьютора АО «ЮЕ-Интернейшнл»

SINEAX VS70

Power supply for the CB-Power-Bus

Features / Benefits

- Bridging power supply through the DIN rail bus connector (CB-Power-Bus)
- Redundant power supply
- Built-in over-voltage (surge) protection
- Supply of up to 75 modules
- Two individual power supply sources can be connected to one SINEAX VS70 module
- Small dimensions (6.2 x 93.1 x 102.5 mm)
- Spring cage clamp connection

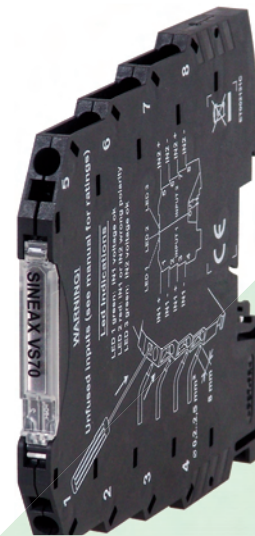

General Data

Power supply	19.2 ... 30 V DC
Power consumption	Max. 5 mA per input
Current capacity	– Max. 1.6 A with one single input – Max. 2 A if input 1 and input 2 connected in parallel
IP protection	IP 20
Housing	Terminal housing for mounting on 35 mm DIN 46277
Dimensions	6,2 x 93,1 x 102,5 mm (w x h x d)
Weight	50 g
Operating temperature	– 20 ... + 65 °C
Connections	Spring cage clamp
Conformity	CE

Order Codes

Description	Code
Power supply module with surge protection	162 818
CB-Power-Bus Expandable power supply connector	162 826

Installation

Inserting / Extracting module on DIN guide

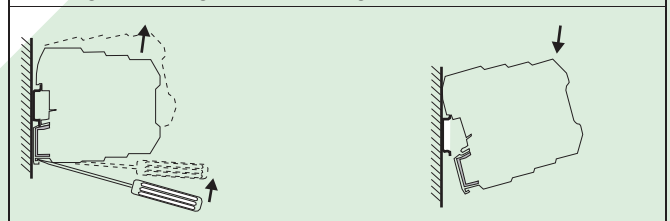

Expandable connector CB-Power-Bus

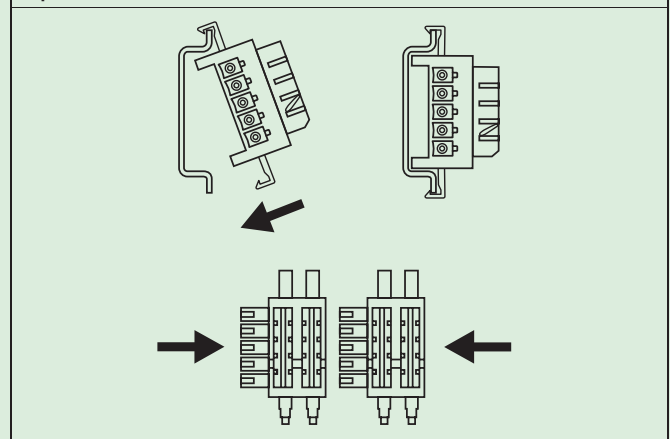

SINEAX VS70

Power supply for the CB-Power-Bus

Spring cage clamp connection

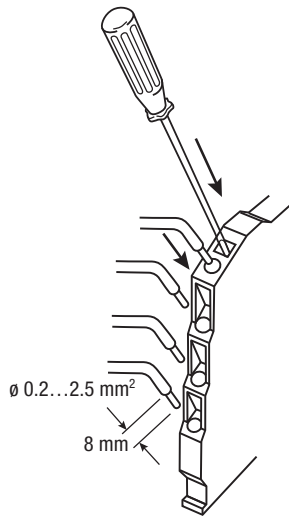

Internal wiring

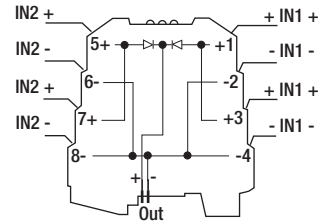

Dimensional drawing

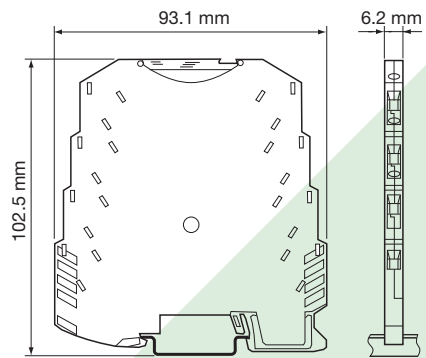

Electrical connections

Example of connection with redundant power supply

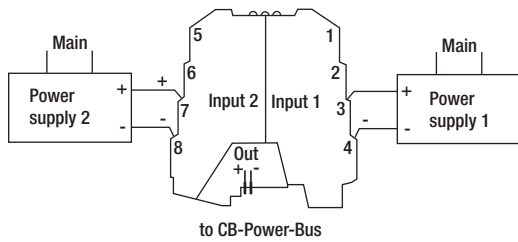

Example of connection to more than one bus

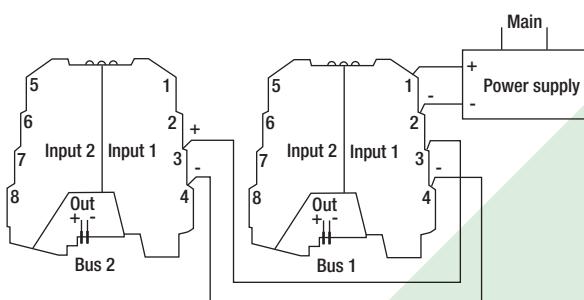

Example of connection with inputs connected in parallel: 2 A output

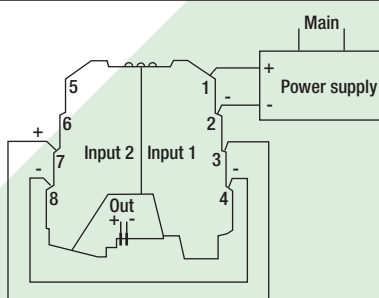

 **CAMILLE BAUER**
Rely on us.

По вопросам продажи и поддержки обращайтесь:

Архангельск (8182)63-90-72
Астана (7172)727-132
Астрахань (8512)99-46-04
Барнаул (3852)73-04-60
Белгород (4722)40-23-64
Брянск (4832)59-03-52
Владивосток (423)249-28-31
Волгоград (844)278-03-48
Вологда (8172)26-41-59
Воронеж (473)204-51-73
Екатеринбург (343)384-55-89
Иваново (4932)77-34-06
Ижевск (3412)26-03-58
Казань (843)206-01-48



Калининград (4012)72-03-81
Калуга (4842)92-23-67
Кемерово (3842)65-04-62
Киров (8332)68-02-04
Краснодар (861)203-40-90
Красноярск (391)204-63-61
Курск (4712)77-13-04
Липецк (4742)52-20-81
Магнитогорск (3519)55-03-13
Москва (495)268-04-70
Мурманск (8152)59-64-93
Набережные Челны (8552)20-53-41
Нижний Новгород (831)429-08-12
Новокузнецк (3843)20-46-81

Новосибирск (383)227-86-73
Омск (3812)21-46-40
Орел (4862)44-53-42
Оренбург (3532)37-68-04
Пенза (8412)22-31-16
Пермь (342)205-81-47
Ростов-на-Дону (863)308-18-15
Рязань (4912)46-61-64
Самара (846)206-03-16
Санкт-Петербург (812)309-46-40
Саратов (845)249-38-78
Севастополь (8692)22-31-93
Симферополь (3652)67-13-56
Смоленск (4812)29-41-54



Сочи (862)225-72-31
Ставрополь (8652)20-65-13
Сургут (3462)77-98-35
Тверь (4822)63-31-35
Томск (3822)98-41-53
Тула (4872)74-02-29
Тюмень (3452)66-21-18
Ульяновск (8422)24-23-59
Уфа (347)229-48-12
Хабаровск (4212)92-98-04
Челябинск (351)202-03-61
Череповец (8202)49-02-64
Ярославль (4852)69-52-93

Единый адрес для всех регионов: cmn@nt-rt.ru || www.camille-bauer.nt-rt.ru

PROCESS CONTROL ENGINEERING

ANGULAR POSITION ENGINEERING

HEAVY CURRENT ENGINEERING

