

Модуль сигнализации SINEAX C402

Архангельск (8182)63-90-72
Астана (7172)727-132
Астрахань (8512)99-46-04
Барнаул (3852)73-04-60
Белгород (4722)40-23-64
Брянск (4832)59-03-52
Владивосток (423)249-28-31
Волгоград (844)278-03-48
Вологда (8172)26-41-59
Воронеж (473)204-51-73
Екатеринбург (343)384-55-89
Иваново (4932)77-34-06
Ижевск (3412)26-03-58
Казань (843)206-01-48

Калининград (4012)72-03-81
Калуга (4842)92-23-67
Кемерово (3842)65-04-62
Киров (8332)68-02-04
Краснодар (861)203-40-90
Красноярск (391)204-63-61
Курск (4712)77-13-04
Липецк (4742)52-20-81
Магнитогорск (3519)55-03-13
Москва (495)268-04-70
Мурманск (8152)59-64-93
Набережные Челны (8552)20-53-41
Нижний Новгород (831)429-08-12
Новокузнецк (3843)20-46-81

Новосибирск (383)227-86-73
Омск (3812)21-46-40
Орел (4862)44-53-42
Оренбург (3532)37-68-04
Пенза (8412)22-31-16
Пермь (342)205-81-47
Ростов-на-Дону (863)308-18-15
Рязань (4912)46-61-64
Самара (846)206-03-16
Санкт-Петербург (812)309-46-40
Саратов (845)249-38-78
Севастополь (8692)22-31-93
Симферополь (3652)67-13-56
Смоленск (4812)29-41-54

Сочи (862)225-72-31
Ставрополь (8652)20-65-13
Сургут (3462)77-98-35
Тверь (4822)63-31-35
Томск (3822)98-41-53
Тула (4872)74-02-29
Тюмень (3452)66-21-18
Ульяновск (8422)24-23-59
Уфа (347)229-48-12
Хабаровск (4212)92-98-04
Челябинск (351)202-03-61
Череповец (8202)49-02-64
Ярославль (4852)69-52-93

Единый адрес для всех регионов: cmn@nt-rt.ru || www.camille-bauer.nt-rt.ru

использовано с разрешения официального
дистрибьютора АО «ЮЕ-Интернейшнл»

SINEAX C 402

Alarm unit

for DC currents or DC voltages

CE₀₁₀₂ Ex II (1) G

Application

The alarm unit **SINEAX C402** (Figure 1) is normally applied to monitor the limits of both current and voltage measurements. The status of the device is signalled remotely by a relay and locally by LED's. The electrical insulation between input, output relay contacts and the power supply conforms to IEC 1010. The value detected by the alarm unit is set on a potentiometer and measured at test sockets on the front of the unit.

The alarm unit fulfils all the important requirements and regulations concerning electromagnetic compatibility **EMC** and **Safety** (IEC 1010 resp. EN 61 010). It was developed and is manufactured and tested in strict accordance with the **quality assurance standard** ISO 9001.

Production QA is also certified according to guideline 94/9/EG.

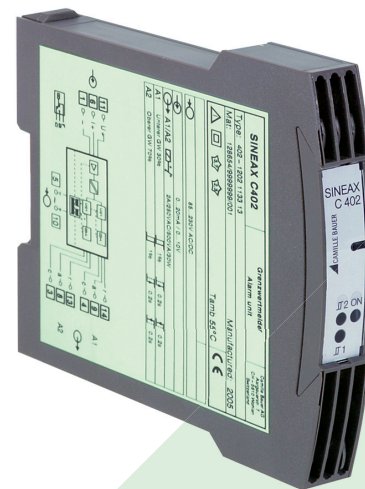

Fig. 1. SINEAX C 402-1 with 2 relay outputs with 1 changeover contact each, in housing S17.

Features / Benefits

- With 2 alarm circuits
- Analogous trip point adjusted by 12-turn potentiometer, adjusted trip point measurable on test sockets, $0 \dots 1 \text{ V} \cong 0 \dots 100\%$
- Sense of relay action and associated LED's switchable by jumpers
- Electrical insulation between measuring input, contact outputs and power supply / Fulfils EN 61 010
- Non-standard user-specific ranges available
- AC/DC power supply / Universal
- Available in type of protection "Intrinsic safety" [EEx ia] IIC (see "Table 3: Data on explosion protection")
- Provision for either snapping the alarm unit onto top-hat rails or securing it with screws to a wall or panel

Technical data

Measuring input \rightarrow

DC current:

Standard ranges
0...20 mA, 4...20 mA, ± 20 mA

Limits

0...0.1 to 0...50 mA
also live zero,
initial value > 0 to $\leq 50\%$ of end value
 $-0.1 \dots 0 \dots +0.1$ to
 $-50 \dots 0 \dots +50$ mA
also bipolar asymmetric

$R_i = 15 \Omega$

DC voltage:

Standard ranges
0...10 V, 2...10 V, ± 10 V

Limits

0...0.06 to 0...40, **Ex max. 30 V**
also live zero,
initial value > 0 to $\leq 50\%$ of end value
 $-0.06 \dots 0 \dots +0.06$ to
 $-40 \dots 0 \dots +40$ V,
Ex max. -30...0...+30 V

$R_i = 100 \text{ k}\Omega$

SINEAX C 402

Alarm unit

Overload capacity: DC current continuously 2-fold
DC voltage continuously 2-fold

Contact outputs A1/A2 \rightarrow

SINEAX in housing S17: 2 relay outputs,
1 potentialfree changeover contact per trip point

Trip point type: Switching function adjustable by jumpers ST2 and ST6 as low or high trip point (see Fig. 2)

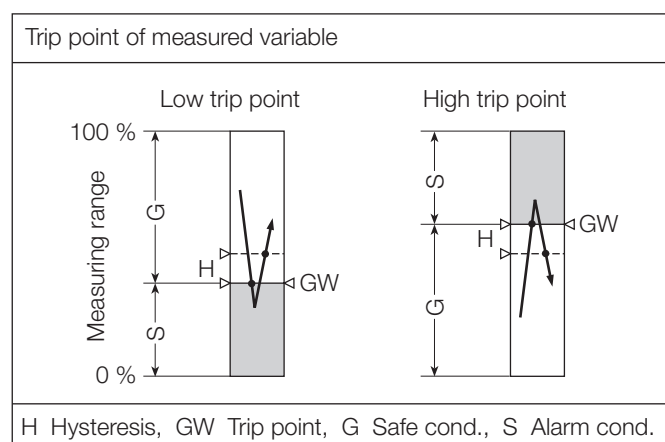

Fig. 2. Switching function, according to trip point type.

Trip point adjustment: By 12-turn potentiometer Ⓢ J1 and Ⓢ J2 for GW1 and GW2
Adjusted trip point measurable on test sockets with separate voltmeter $R_i > 10 \text{ M}\Omega$,
0 ... 1 V \cong 0 ... 100%
Test switch ⌀ 2 mm

Hysteresis: Standard 1%,
between > 1 and 10% acc. to order

Energizing and deenergizing delays: Standard 0.2 s
between 0.1 and 10 s acc. to order

Sense of relay action: Adjustable by jumpers J4 and J8 (see Fig. 3)

Display of switching state: GW1 and GW2 by yellow LED's J1 and J2, display mode adjustable by jumpers J5 and J9 (see Fig. 3)

Contact rating: AC: $\leq 2 \text{ A} / 250 \text{ V}$ (500 VA)
DC: $\leq 1 \text{ A} / 0.1 \dots 250 \text{ V}$ (30 W)
Gold flashed contacts silver alloy
(Relay approved by UL, CSA, TÜV, SEV)

Power supply H \rightarrow Ⓢ

AC/DC module (DC and 45...400 Hz)

Table 1: Nominal voltages and tolerance

Nominal voltage U_N	Tolerance	Instruments version
24... 60 V DC / AC	DC - 15...+ 33%	Standard (Non-Ex)
85...230 V ¹ DC / AC	AC $\pm 15\%$	
24... 60 V DC / AC	DC - 15...+ 33%	Type of protection "Intrinsic safety" [Ex ia] IIC
85...230 V AC	$\pm 10\%$	
85...110 V DC	-15...+ 10%	

Power consumption: $\leq 1.2 \text{ W}$ resp. $\leq 3 \text{ VA}$

Accuracy data (acc. to DIN/IEC 770)

Reference conditions: Ambient temperature $23 \text{ }^\circ\text{C}$, $\pm 1 \text{ K}$

Accuracy of the pick-up value: Max. $\pm 1\%$

Repeatability of the setting: Max. $\pm 0.2\%$

Temperature influence: $< \pm 0.1\%$ pro 10 K

Installation data

Mechanical design: Housing S17
Dimensions see Section "Dimensional drawings"

Material of housing: Lexan 940 (polycarbonate)
Flammability Class V-0 acc. to UL 94, self-extinguishing, non-dripping, free of halogen

Mounting: For snapping onto top-hat rail (35 x 15 mm or 35 x 7,5 mm) acc. to EN 50 022

or
directly onto a wall or panel using the pull-out screw hole brackets

Position of use: Any

Electrical terminals: DIN/VDE 0609
Screw terminals with wire guards, for light PVC wiring and max. $2 \times 0,75 \text{ mm}^2$ or $1 \times 2,5 \text{ mm}^2$

Seismic test: 2 g acc. to EN 60 068-2-6

Shock: 50 g,
3 shocks in each of 6 directions acc. to EN 60 068-2-27

Weight: Approx. 180 g

¹ For power supplies > 125 V, the auxiliary circuit should include an external fuse with a rating $\leq 20 \text{ A DC}$.

SINEAX C 402

Alarm unit

Electrical isolation:

All circuits (measuring input/contact outputs/power supply) electrically insulated

Double insulation:

- Power supply versus all other circuits
- Measuring output versus output contacts

Regulations

Electromagnetic compatibility:

The standards DIN EN 50 081-2 and DIN EN 50 082-2 are observed

Intrinsically safe:

Acc. to EN 50 020: 1996-04

Protection (acc. to IEC 529 resp. EN 60 529):

Housing IP 40
Terminals IP 20

Electrical standards:

Acc. to IEC 1010 resp. EN 61 010

Operating voltages:

< 300 V between all insulated circuits

Contamination level:

2

Overvoltage category acc. to IEC 664:

III for power supply
II for measuring input and contact output

Test voltage:

50 Hz, 1 min. acc. to DIN EN 61 010-1
2300 V, Input versus outputs and outputs versus each other
3700 V, Power supply versus all circuits

Environmental conditions

Commissioning temperature:

– 10 to + 55 °C

Operating temperature:

– 25 to + 55 °C,
Ex – 20 to + 55 °C

Storage temperature:

– 40 to + 70 °C

Annual mean relative humidity:

≤ 75%

Altitude:

2000 m max.

Indoor use statement!

Table 2: Coding of the variants

Designation	*Blocking code	no-go with blocking code	Article No./ Feature
SINEAX C402	Order Code 402 - xxxx xxxx xx		402 –
Features, Selection			
1. Mechanical design			
Housing S17 for rail and wall mounting			1
2. Version / Power supply			
Standard / 24 ... 60 V DC/AC			1
Standard / 85 ... 230 V DC/AC			2
[Ex ia] IIC, Input circuit intrinsically safe / 24 ... 60 V DC/AC			3
[Ex ia] IIC, Input circuit intrinsically safe / 85 ... 110 V DC / 85 ... 230 V AC			4
3. Measuring input			
0 ... 20 mA / 0 ... 10 V, zero point changeable			0
Non-standard [V]			9
Non-standard [mA]			Z
Line 9: [V] 0...0.06 to 0...≤ 40 V, (Ex max. 30 V), also live zero, initial value > 0 to ≤ 50% of end value [V] –0.06...+ 0.06 to –40...+ 40 V, (Ex max. –30...+ 30), also bipolar asymmetric			
Line Z: [mA] 0...0.1 to 0...50 mA, also live zero, initial value > 0 to ≤ 50% of end value [mA] –0.1...+ 0.1 to –50...+ 50 mA, also bipolar asymmetric			
4. Trip points / contact outputs			
2 trip points / 1 changeover contact per trip point			2

SINEAX C 402

Alarm unit

Designation	*Blocking code	no-go with blocking code	Article No./ Feature
SINEAX C402	Order Code 402 - xxxx xxxx xx		402 -
Features, Selection			
5. Trip point 1, type, hysteresis			
Low alarm, hysteresis 1%			1
Low alarm, hysteresis [%]			2
High alarm, hysteresis 1%			3
High alarm, hysteresis [%]			4
Lines 2 and 4: Hysteresis [%] > 1.0 to 10			
6. Trip point 1, energizing/deenergizing delay			
Energizing/deenergizing 0.2 s			1
Energizing/deenergizing [s]			2
Energizing 0.2 s / deenergizing [s]			3
Deenergizing 0.2 s / energizing [s]			4
Lines 2 to 4: switching delay [s] 0.10 to 10			
7. Trip point 1, sense of action			
Relay energized: alarm condition / LED lit-up: alarm condition			1
Relay energized: alarm condition / LED lit-up: safe condition			2
Relay energized: safe condition / LED lit-up: alarm condition			3
Relay energized: safe condition / LED lit-up: alarm condition			4
8. Trip point 2, type, hysteresis			
Low alarm, hysteresis 1%			1
Low alarm, hysteresis [%]			2
High alarm, hysteresis 1%			3
High alarm, hysteresis [%]			4
Lines 2 and 4: hysteresis [%] > 1.0 to 10			
9. Trip point 2, energizing/deenergizing delay			
Energizing/deenergizing 0.2 s			1
Energizing/deenergizing [s]			2
Energizing 0.2 s / deenergizing [s]			3
Deenergizing 0.2 s / Energizing [s]			4
Lines 2 to 4: switching delay [s] 0.10 to 10			
10. Trip point 2, sense of action			
Relay energized: alarm condition / LED lit-up: alarm condition			1
Relay energized: alarm condition / LED lit-up: safe condition			2
Relay energized: safe condition / LED lit-up: alarm condition			3
Relay energized: safe condition / LED lit-up: alarm condition			4

* Lines with letter's under "no-go" cannot be combined with preceding lines having the same letter under "Blocking code".

Table 3: Data on explosion protection  **II (1) G**

Order Code	Type of protection	Input	Output	Type examination certificate	Mounting location
402-1...	[EEx ia] IIC	$U_o = 6 \text{ V}$ $I_o = 63 \text{ } \mu\text{A}$ $L_i = 20 \text{ } \mu\text{H}$ $C_i = 20 \text{ nF}$ only for connection to certified intrinsically safe circuits with following maximum values: $U_o = 30 \text{ V}$	$U_m = 253 \text{ V AC}$ resp. 125 V DC	PTB 97 ATEX 2192	Outside the hazardous area

SINEAX C 402



Alarm unit

Configuration

The instrument has to be opened before it can be configured.

Input standard ranges

The measuring output can be configured by inserting the plug-in jumper **J1** in position "B1, B2 or B2".

Measuring input \rightarrow	Plug-in jumper J1
4 ... 20 mA / 2 ... 10 V	 B1
0 ... 20 mA / 0 ... 10 V	 B2
\pm 20 mA / \pm 10 V	 B3









Type of measuring input (current or voltage signal)

Choice of terminals determines whether the alarm unit input monitors a current or a voltage.

Measuring input \rightarrow	Pins
Current [mA]	1 - 6 I +
Voltage [V]	1 - 11 U +









Switching function (trip point type)

The positions of the plug-in jumpers ST 2 and ST 6 determine the operating mode of the alarm unit (minimum or maximum limit).

Trip point	Trip point type	Plug-in jumpers		Position
		ST 2	ST 6	
GW2	higher			a
	lower			b
GW1	higher			a
	lower			b









Sense of relay action

The sense of relay action can be set with the aid of plug-in jumpers J4 and J8.

Operating status	Relay	Operating sense	Jumpers		Position
			J4	J8	
Alarm condition	GW 2	Relay energized			a
Safe condition					b
Alarm condition	GW 1				a
Safe condition					b

Operating sense of LED's

The operating sense can be set with the aid of plug-in jumpers J5 and J9.

Operating status	LED's	Operating sense	Jumpers		Position
			J5	J9	
Alarm condition	GW 2	LED lit-up			b
Safe condition					a
Alarm condition	GW 1				b
Safe condition					a

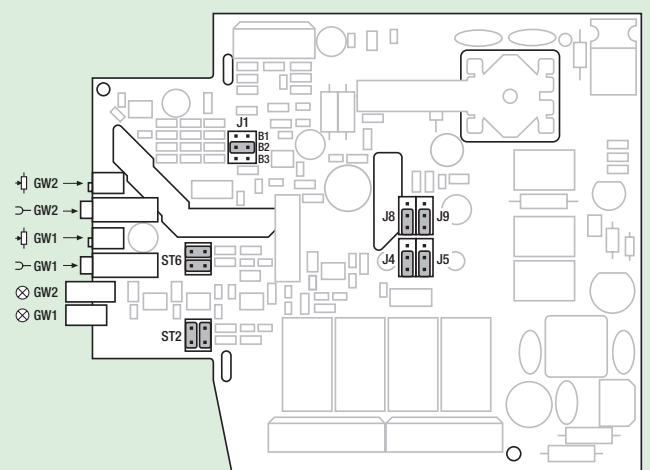
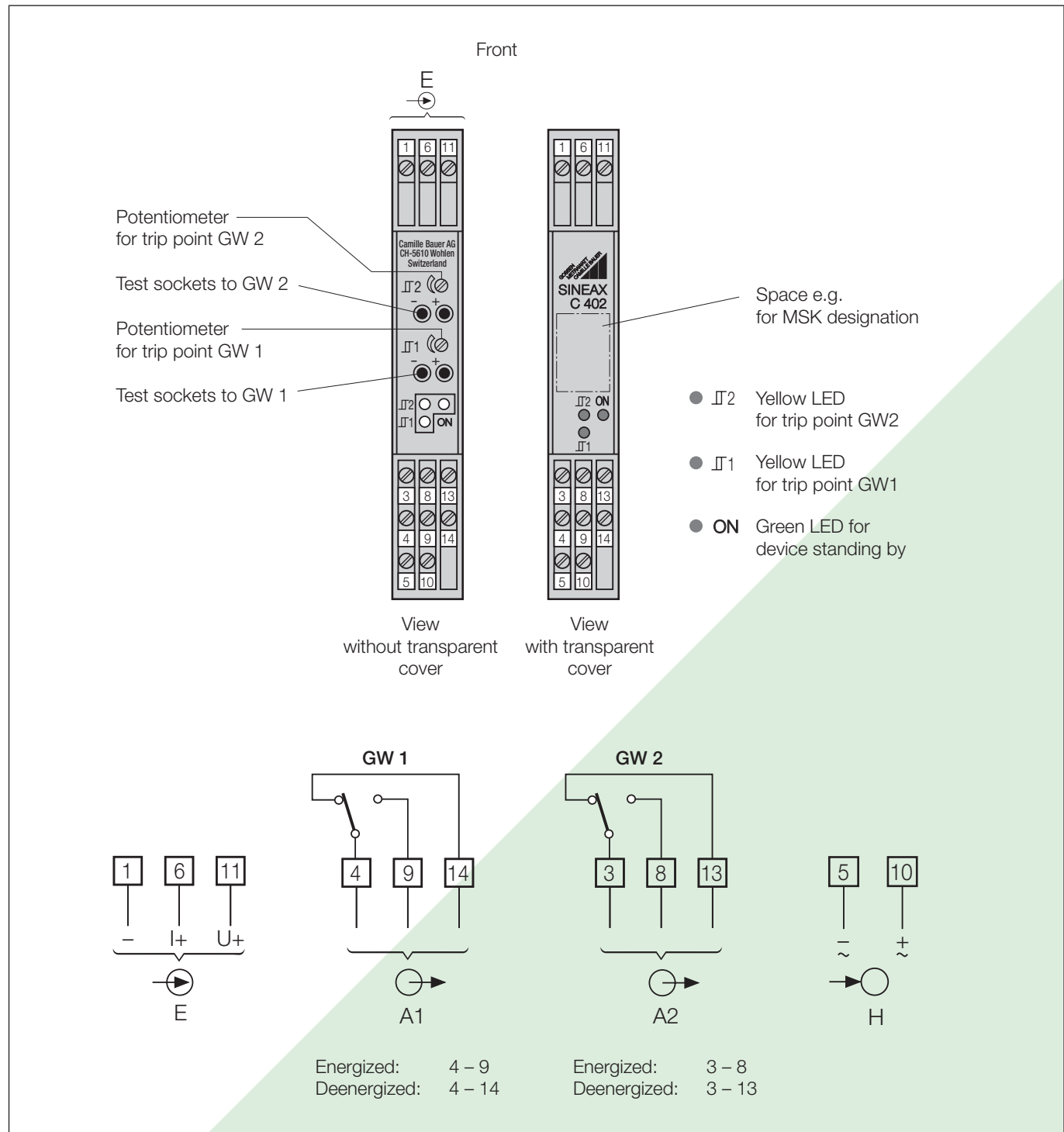

Fig. 3. Positions of the plug-in jumpers, potentiometers, test sockets and LED's.

SINEAX C 402

Alarm unit

Electrical connections



E = Measuring input

A1, A2 = Output contacts for monitoring the trip points GW1, GW2

H = Power supply

SINEAX C 402

Alarm unit

Dimensional drawings

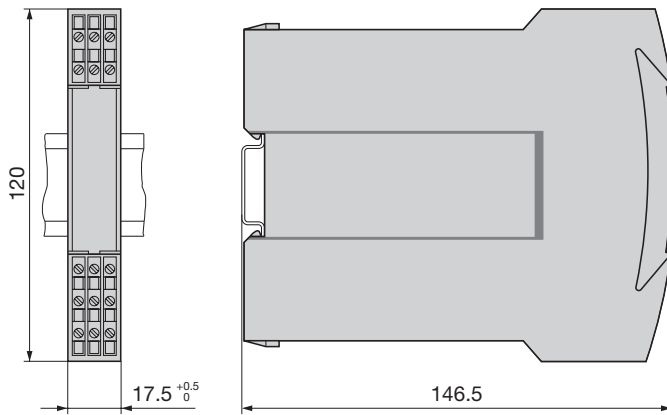

Fig. 4. SINEAX C 402-1 in housing S17 clipped onto a top-hat rail (35 x 15 mm or 35 x 7,5 mm, acc. to EN 50 022).

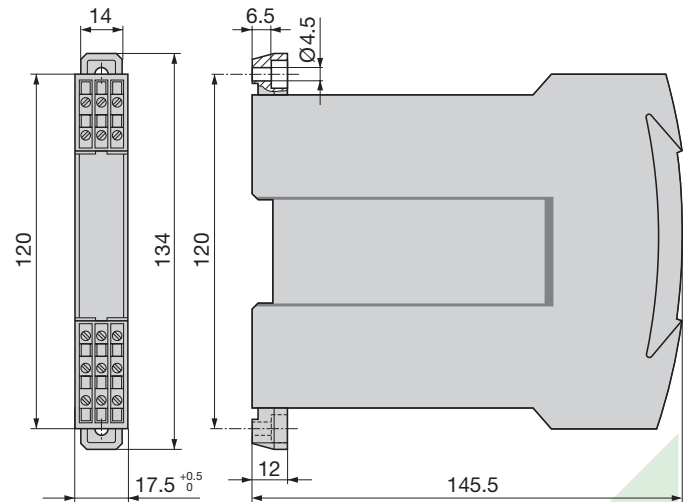

Fig. 5. SINEAX C 402-1 in housing S17, screw hole mounting brackets pulled out.

Standard accessories

- 1 Operating instructions in three languages: German, French, English
- 2 Withdrawing handle (for opening the housing)
- 2 Labels (under transparent cover)
- 1 Type Examination Certificate (for instruments in type of protection "Intrinsically safe" only)

По вопросам продажи и поддержки обращайтесь:

Архангельск (8182)63-90-72
Астана (7172)727-132
Астрахань (8512)99-46-04
Барнаул (3852)73-04-60
Белгород (4722)40-23-64
Брянск (4832)59-03-52
Владивосток (423)249-28-31
Волгоград (844)278-03-48
Вологда (8172)26-41-59
Воронеж (473)204-51-73
Екатеринбург (343)384-55-89
Иваново (4932)77-34-06
Ижевск (3412)26-03-58
Казань (843)206-01-48

Калининград (4012)72-03-81
Калуга (4842)92-23-67
Кемерово (3842)65-04-62
Киров (8332)68-02-04
Краснодар (861)203-40-90
Красноярск (391)204-63-61
Курск (4712)77-13-04
Липецк (4742)52-20-81
Магнитогорск (3519)55-03-13
Москва (495)268-04-70
Мурманск (8152)59-64-93
Набережные Челны (8552)20-53-41
Нижний Новгород (831)429-08-12
Новокузнецк (3843)20-46-81

Новосибирск (383)227-86-73
Омск (3812)21-46-40
Орел (4862)44-53-42
Оренбург (3532)37-68-04
Пенза (8412)22-31-16
Пермь (342)205-81-47
Ростов-на-Дону (863)308-18-15
Рязань (4912)46-61-64
Самара (846)206-03-16
Санкт-Петербург (812)309-46-40
Саратов (845)249-38-78
Севастополь (8692)22-31-93
Симферополь (3652)67-13-56
Смоленск (4812)29-41-54

Сочи (862)225-72-31
Ставрополь (8652)20-65-13
Сургут (3462)77-98-35
Тверь (4822)63-31-35
Томск (3822)98-41-53
Тула (4872)74-02-29
Тюмень (3452)66-21-18
Ульяновск (8422)24-23-59
Уфа (347)229-48-12
Хабаровск (4212)92-98-04
Челябинск (351)202-03-61
Череповец (8202)49-02-64
Ярославль (4852)69-52-93

Единый адрес для всех регионов: cmn@nt-rt.ru || www.camille-bauer.nt-rt.ru

PROCESS CONTROL ENGINEERING



ANGULAR POSITION ENGINEERING



HEAVY CURRENT ENGINEERING

