



## Многофункциональный преобразователь SINEAX AM3000

Архангельск (8182)63-90-72  
Астана (7172)727-132  
Астрахань (8512)99-46-04  
Барнаул (3852)73-04-60  
Белгород (4722)40-23-64  
Брянск (4832)59-03-52  
Владивосток (423)249-28-31  
Волгоград (844)278-03-48  
Вологда (8172)26-41-59  
Воронеж (473)204-51-73  
Екатеринбург (343)384-55-89  
Иваново (4932)77-34-06  
Ижевск (3412)26-03-58  
Казань (843)206-01-48

Калининград (4012)72-03-81  
Калуга (4842)92-23-67  
Кемерово (3842)65-04-62  
Киров (8332)68-02-04  
Краснодар (861)203-40-90  
Красноярск (391)204-63-61  
Курск (4712)77-13-04  
Липецк (4742)52-20-81  
Магнитогорск (3519)55-03-13  
Москва (495)268-04-70  
Мурманск (8152)59-64-93  
Набережные Челны (8552)20-53-41  
Нижний Новгород (831)429-08-12  
Новокузнецк (3843)20-46-81

Новосибирск (383)227-86-73  
Омск (3812)21-46-40  
Орел (4862)44-53-42  
Оренбург (3532)37-68-04  
Пенза (8412)22-31-16  
Пермь (342)205-81-47  
Ростов-на-Дону (863)308-18-15  
Рязань (4912)46-61-64  
Самара (846)206-03-16  
Санкт-Петербург (812)309-46-40  
Саратов (845)249-38-78  
Севастополь (8692)22-31-93  
Симферополь (3652)67-13-56  
Смоленск (4812)29-41-54

Сочи (862)225-72-31  
Ставрополь (8652)20-65-13  
Сургут (3462)77-98-35  
Тверь (4822)63-31-35  
Томск (3822)98-41-53  
Тула (4872)74-02-29  
Тюмень (3452)66-21-18  
Ульяновск (8422)24-23-59  
Уфа (347)229-48-12  
Хабаровск (4212)92-98-04  
Челябинск (351)202-03-61  
Череповец (8202)49-02-64  
Ярославль (4852)69-52-93

Единый адрес для всех регионов: [cmn@nt-rt.ru](mailto:cmn@nt-rt.ru) || [www.camille-bauer.nt-rt.ru](http://www.camille-bauer.nt-rt.ru)

использовано с разрешения официального  
дистрибьютора АО «ЮЕ-Интернейшл»

## Warning notices

In this document warning notices are used, which you have to observe to ensure personal safety and to prevent damage to property. Depending on the degree of danger the following symbols are used:



If the warning notice is not followed death or severe personal injury **will** result.



If the warning notice is not followed damage to property or severe personal injury **may** result.



If the warning notice is not followed the device **may** be damaged or **may** not fulfill the expected functionality.

## Qualified personnel

The product described in this document may be handled by personnel only, which is qualified for the respective task. Qualified personnel have the training and experience to identify risks and potential hazards when working with the product. Qualified personnel are also able to understand and follow the given safety and warning notices.

## Intended use

The product described in this document may be used only for the application specified. The maximum electrical supply data and ambient conditions specified in the technical data section must be adhered. For the perfect and safe operation of the device proper transport and storage as well as professional assembly, installation, handling and maintenance are required.

## Disclaimer of liability

The content of this document has been reviewed to ensure correctness. Nevertheless it may contain errors or inconsistencies and we cannot guarantee completeness and correctness. This is especially true for different language versions of this document. This document is regularly reviewed and updated.

## Contents

<b>1. Introduction .....</b>	<b>5</b>
1.1 Purpose of this document.....	5
1.2 Scope of supply.....	5
1.3 Further documents .....	5
<b>2. Safety notes .....</b>	<b>6</b>
<b>3. Device overview.....</b>	<b>6</b>
3.1 Brief description.....	6
3.2 Available measurement data .....	6
<b>4. Mechanical mounting.....</b>	<b>7</b>
4.1 Panel cutout .....	7
4.2 Mounting of the device .....	7
4.3 Demounting of the device.....	7
<b>5. Electrical connections .....</b>	<b>8</b>
5.1 General safety notes .....	8
5.2 Terminal assignments of the I/O extensions .....	9
5.3 Possible cross sections and tightening torques .....	9
5.4 Inputs .....	10
5.5 Power supply.....	22
5.6 Relays .....	22
5.7 Digital inputs.....	22
5.8 Digital outputs .....	23
5.9 Analog outputs .....	24
5.10 Modbus interface RS485 .....	24
5.11 Uninterruptible power supply (UPS) .....	25
<b>6. Commissioning.....</b>	<b>26</b>
6.1 Parametrization of the device functionality.....	26
6.2 Installation check.....	27
6.3 Simulation of I/Os .....	28
6.4 Ethernet installation.....	28
6.4.1 Settings .....	28
6.4.2 Connection .....	30
6.5 Protection against device data changing .....	31
<b>7. Operating the device .....</b>	<b>32</b>
7.1 Operating elements.....	32
7.2 Selecting the information to display .....	32
7.3 Measurement displays and used symbols .....	33
7.4 Resetting measurement data.....	35
7.5 Configuration.....	35
7.5.1 Configuration at the device .....	35
7.5.2 Configuration via web browser .....	36
7.6 Alarming.....	38
7.6.1 Limit values.....	38
7.6.2 Monitoring functions.....	39
7.6.3 Summary alarm .....	40
7.7 Data recording.....	41
7.7.1 Periodical data.....	41
7.7.2 Events .....	44

7.7.3	Disturbance recorder .....	45
7.7.4	Micro SD card .....	47
7.8	Timeouts .....	48
<b>8.</b>	<b>Service, maintenance and disposal .....</b>	<b>49</b>
8.1	Calibration and new adjustment .....	49
8.2	Cleaning.....	49
8.3	Battery .....	49
8.4	Disposal.....	49
<b>9.</b>	<b>Technical data.....</b>	<b>50</b>
<b>10.</b>	<b>Dimensional drawings.....</b>	<b>56</b>
<b>Annex</b> .....	<b>57</b>	
<b>A</b>	<b>Description of measured quantities.....</b>	<b>57</b>
A1	Basic measurements.....	57
A2	Harmonic analysis.....	61
A3	System imbalance.....	62
A4	Mean values and trend.....	63
A5	Meters.....	64
<b>B</b>	<b>Display matrices .....</b>	<b>65</b>
B0	Used abbreviations for the measurements .....	65
B1	Display matrices for single phase system.....	69
B2	Display matrices for split-phase (two-phase) systems .....	70
B3	Display matrices for 3-wire system, balanced load.....	71
B4	Display matrices for 3-wire system, balanced load, phase shift.....	72
B5	Display matrices for 3-wire systems, unbalanced load .....	73
B6	Display matrices for 3-wire systems, unbalanced load, Aron.....	74
B7	Display matrices for 4-wire system, balanced load.....	75
B8	Display matrices for 4-wire systems, unbalanced load .....	76
B8	Display matrices for 4-wire system, unbalanced load, Open-Y.....	77
<b>C</b>	<b>Logic functions .....</b>	<b>78</b>
<b>D</b>	<b>FCC statement .....</b>	<b>79</b>
<b>INDEX</b> .....	<b>80</b>	

# 1. Introduction

## 1.1 Purpose of this document

This document describes the universal measurement device for heavy-current quantities SINEAX AM3000. It is intended to be used by:

- Installation personnel and commissioning engineers
- Service and maintenance personnel
- Planners

### Scope

This handbook is valid for all hardware versions of the AM3000. Some of the functions described in this document are available only, if the necessary optional components are included in the device.

### Required knowledge

A general knowledge in the field of electrical engineering is required. For assembly and installation of the device knowledge of applicable national safety regulations and installation standard is required.

## 1.2 Scope of supply



- Measurement device SINEAX AM3000
- Safety instructions (multiple languages)
- Mounting set: 2 mounting clamps
- Battery pack (optional, for devices with UPS only)

## 1.3 Further documents

The following documents are provided electronically

- Safety instructions SINEAX AM2000 / SINEAX AM3000
- Data sheet SINEAX AM1000/AM2000/AM3000
- Modbus basics: General description of the communication protocol
- Modbus interface SINEAX AMx000: Register description of Modbus communication

## 2. Safety notes



Device may only be disposed in a professional manner!

The installation and commissioning should only be carried out by trained personnel.

Check the following points before commissioning:

- that the maximum values for all the connections are not exceeded, see "Technical data" section,
- that the connection wires are not damaged, and that they are not live during wiring,
- that the power flow direction and the phase rotation are correct.

The instrument must be taken out of service if safe operation is no longer possible (e.g. visible damage). In this case, all the connections must be switched off. The instrument must be returned to the factory or to an authorized service dealer.

It is forbidden to open the housing and to make modifications to the instrument. The instrument is not equipped with an integrated circuit breaker. During installation check that a labeled switch is installed and that it can easily be reached by the operators.

Unauthorized repair or alteration of the unit invalidates the warranty.

## 3. Device overview

### 3.1 Brief description

The SINEAX AM3000 is a comprehensive instrument for the universal measurement and monitoring in power systems. A full parameterization of all functions of the device is possible directly at the device or via web browser. The universal measurement system of the device may be used directly for any power system, from single phase up to 4-wire unbalanced networks, without hardware modifications.

Using additional, optional components the opportunities of the device may be extended. You may choose from I/O extensions, communication interfaces and data logging. The nameplate on the device gives further details about the present version.

### 3.2 Available measurement data

The SINEAX AM3000 provides measurements in the following subcategories:

- a) **Instantaneous values:** Present TRMS values and associated min/max values
- b) **Energy:** Power mean-values with trend and history as well as energy meters. With the data logger option "periodical data" mean-value progressions (load profiles) and periodical meter readings are available as well.
- c) **Harmonics:** Total harmonic distortion THD/TDD, individual harmonics and their maximum values
- d) **Phasor diagram:** Graphical overview of all current and voltage phasors
- e) **Waveform** of current and voltage inputs
- f) **Events:** State list of monitored alarms. With the data logger option also chronological lists of events and alarms as well as operator events are available.

## 4. Mechanical mounting

► The AM3000 is designed for panel mounting



Please ensure that the operating temperature limits are not exceeded when determining the place of mounting (place of measurement):

**-10 ... 55°C**

### 4.1 Panel cutout

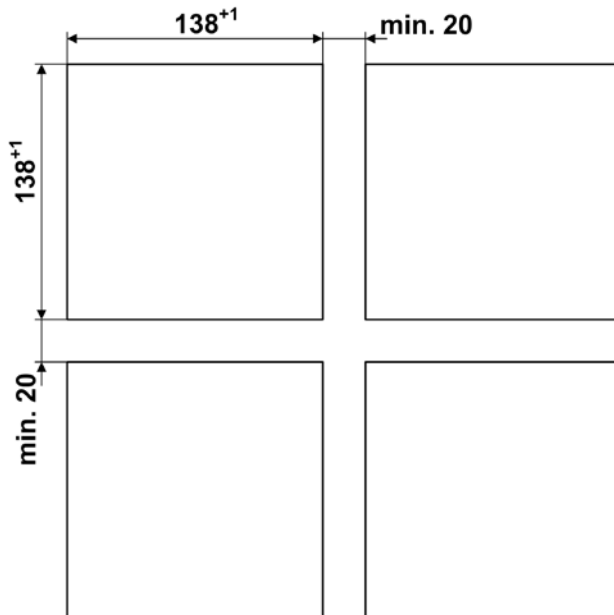

Dimensional drawing AM3000:  
[See section 10](#)

### 4.2 Mounting of the device

The device is suitable for panel widths up to 8mm.

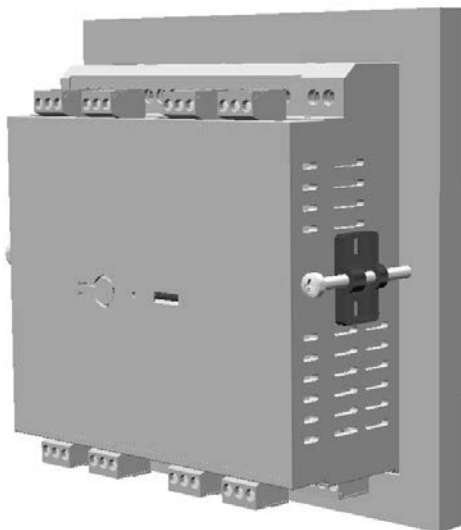

- Slide the device into the cutout from the outside
- From the side slide in the mounting clamps into the intended openings and pull them back about 2 mm
- Tighten the fixation screws until the device is tightly fixed with the panel

### 4.3 Demounting of the device

The demounting of the device may be performed only if all connected wires are out of service. Remove all plug-in terminals and all connections of the current and voltage inputs. Pay attention to the fact, that current transformers must be shorted before removing the current connections to the device. Then demount the device in the opposite order of mounting (4.2).

## 5. Electrical connections



Ensure under all circumstances that the leads are free of potential when connecting them!

### 5.1 General safety notes



Please observe that the data on the type plate must be adhered to!

The national provisions have to be observed in the installation and material selection of electric lines, e.g. in Germany VDE 0100 "Conditions concerning the erection of heavy current facilities with rated voltages below 1000 V"!

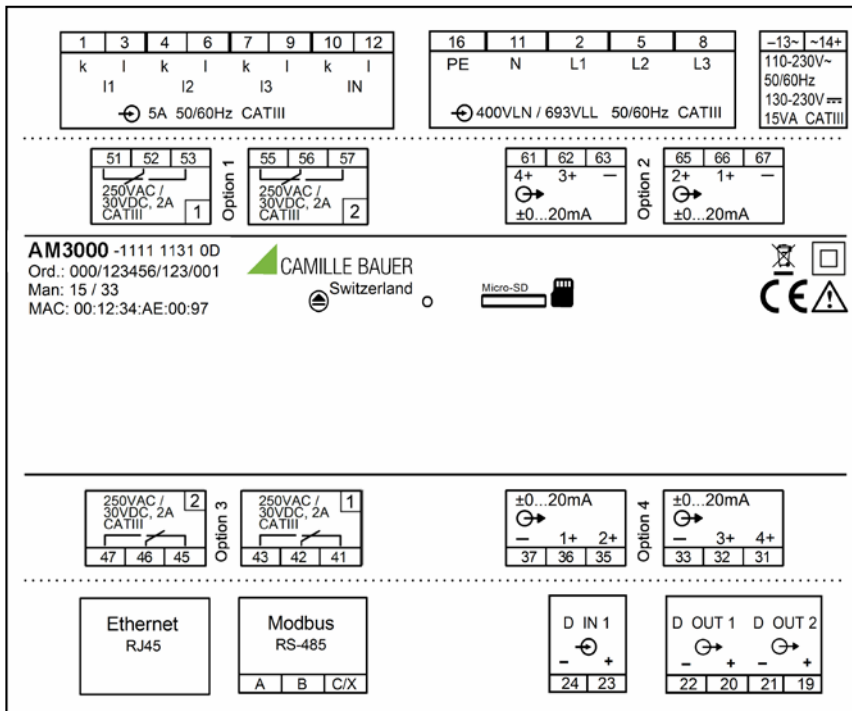

Nameplate of a device with

- Ethernet interface
- Modbus/RTU interface
- 4 relay outputs
- 4 analog outputs
- Data logger

Symbol	Meaning
	Device may only be disposed of in a professional manner!
	Double insulation, device of protection class 2
	CE conformity mark. The device fulfills the requirements of the applicable EU directives.
	Caution! General hazard point. Read the operating instructions.
	General symbol: Input
	General symbol: Output
CAT III	Measurement category CAT III for current / voltage inputs, power supply and relay outputs



## 5.2 Terminal assignments of the I/O extensions

Function	Option 1	Option 2	Option 3	Option 4
2 relay outputs	1.1: 51,52,53 1.2: 55,56,57	2.1: 61,62,63 2.2: 65,66,67	3.1: 41,42,43 3.2: 45,46,47	4.1: 31,32,33 4.2: 35,36,37
2 analog outputs	1.1: 56(+), 57(-) 1.2: 55(+), 57(-)	2.1: 66(+), 67(-) 2.2: 65(+), 67(-)	3.1: 46(+), 47(-) 3.2: 45(+), 47(-)	4.1: 36(+), 37(-) 4.2: 35(+), 37(-)
4 analog outputs	1.1: 56(+), 57(-) 1.2: 55(+), 57(-) 1.3: 52(+), 53(-) 1.4: 51(+), 53(-)	2.1: 66(+), 67(-) 2.2: 65(+), 67(-) 2.3: 62(+), 63(-) 2.4: 61(+), 63(-)	3.1: 46(+), 47(-) 3.2: 45(+), 47(-) 3.3: 42(+), 43(-) 3.4: 41(+), 43(-)	4.1: 36(+), 37(-) 4.2: 35(+), 37(-) 4.3: 32(+), 33(-) 4.4: 31(+), 33(-)
4 digital inputs (active)	1.1: 51(-), 53(+) 1.2: 52(-), 53(+) 1.3: 55(-), 57(+) 1.4: 56(-), 57(+)	2.1: 61(-), 63(+) 2.2: 62(-), 63(+) 2.3: 65(-), 67(+) 2.4: 66(-), 67(+)	3.1: 41(-), 43(+) 3.2: 42(-), 43(+) 3.3: 45(-), 47(+) 3.4: 46(-), 47(+)	4.1: 31(-), 33(+) 4.2: 32(-), 33(+) 4.3: 35(-), 37(+) 4.4: 36(-), 37(+)
4 digital inputs (passive)	1.1: 51(+), 53(-) 1.2: 52(+), 53(-) 1.3: 55(+), 57(-) 1.4: 56(+), 57(-)	2.1: 61(+), 63(-) 2.2: 62(+), 63(-) 2.3: 65(+), 67(-) 2.4: 66(+), 67(-)	3.1: 41(+), 43(-) 3.2: 42(+), 43(-) 3.3: 45(+), 47(-) 3.4: 46(+), 47(-)	4.1: 31(+), 33(-) 4.2: 32(+), 33(-) 4.3: 35(+), 37(-) 4.4: 36(+), 37(-)

## 5.3 Possible cross sections and tightening torques

Inputs L1(2), L2(5), L3(8), N(11), I1(1-3), I2(4-6), I3(7-9), power supply (13-14)

### Single wire

1 x 0,5 ... 6.0mm<sup>2</sup> or 2 x 0,5 ... 2.5mm<sup>2</sup>

### Multiwire with end splices

1 x 0,5 ... 4.0mm<sup>2</sup> or 2 x 0,5 ... 2.5mm<sup>2</sup>

### Tightening torque

0.5...0.6Nm resp. 4.42...5.31 lbf in

I/O's, relays, RS485 connector (A, B, C/X)

### Single wire

1 x 0.5 ... 2.5mm<sup>2</sup> or 2 x 0.5 ... 1.0mm<sup>2</sup>

### Multiwire with end splices

1 x 0.5 ... 2.5mm<sup>2</sup> or 2 x 0.5 ... 1.5mm<sup>2</sup>

### Tightening torque

0.5...0.6Nm resp. 4.42...5.31 lbf in

## 5.4 Inputs



All voltage measurement inputs must originate at circuit breakers or fuses rated 5 Amps or less. This does not apply to the neutral connector. You have to provide a method for manually removing power from the device, such as a clearly labeled circuit breaker or a fused disconnect switch.

When using **voltage transformers** you have to ensure that their secondary connections never will be short-circuited.



No fuse may be connected upstream of the **current measurement inputs!**

When using **current transformers** their secondary connectors must be short-circuited during installation and before removing the device. Never open the secondary circuit under load.

The connection of the inputs depends on the configured system (connection type).

## Single-phase AC mains

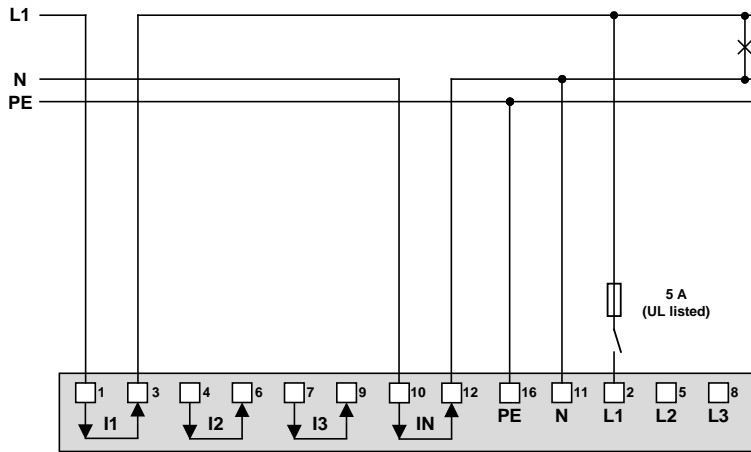

### Direct connection

If current  $I_N$  or voltage  $U_{NE}$  does not need to be measured, connection of IN resp. PE can be omitted.

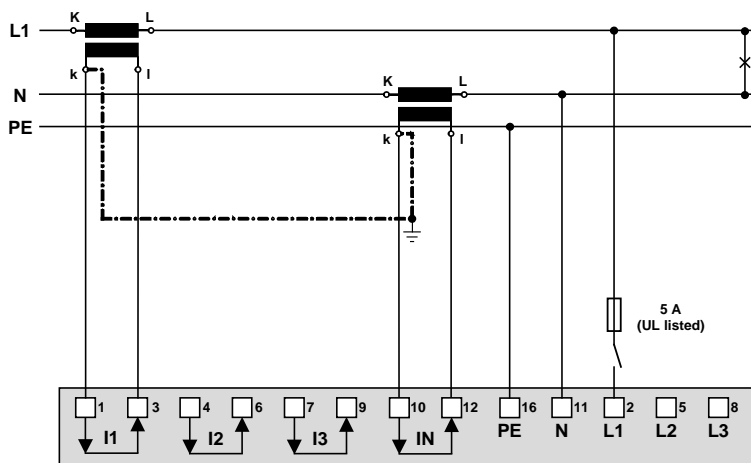

### With current transformer

If current  $I_N$  does not need to be measured, the corresponding transformer can be omitted.

If voltage  $U_{NE}$  does not need to be measured, connection of PE can be omitted.

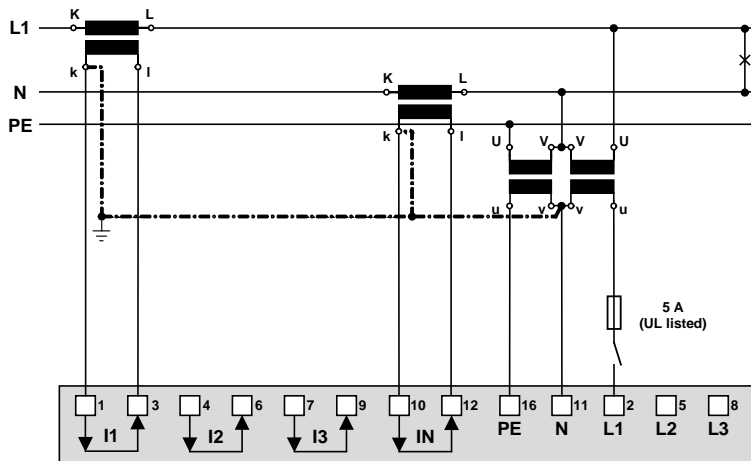

### With current and voltage transformer

If current  $I_N$  or voltage  $U_{NE}$  does not need to be measured, the corresponding transformers can be omitted.

**Three wire system, balanced load, phase shift**  
**current measurement: L1, voltage measurement: L1-L2**

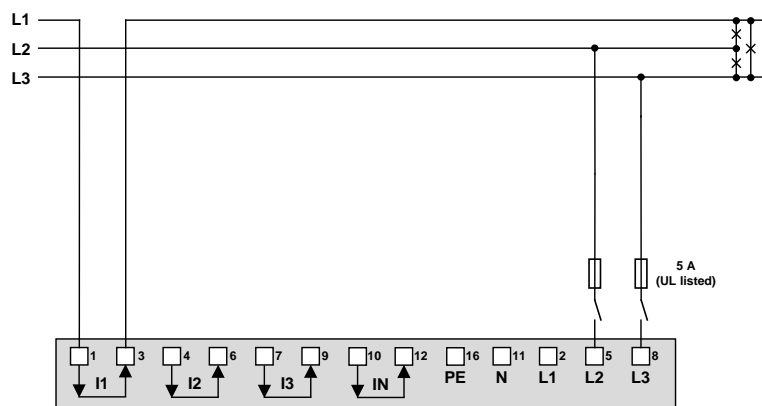

Direct connection

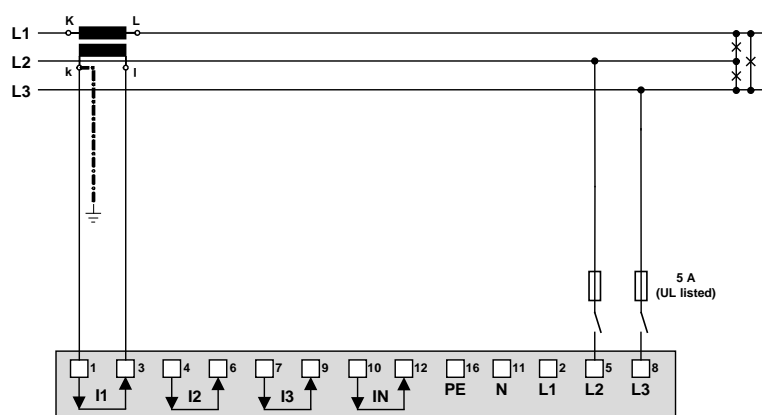

With current transformer

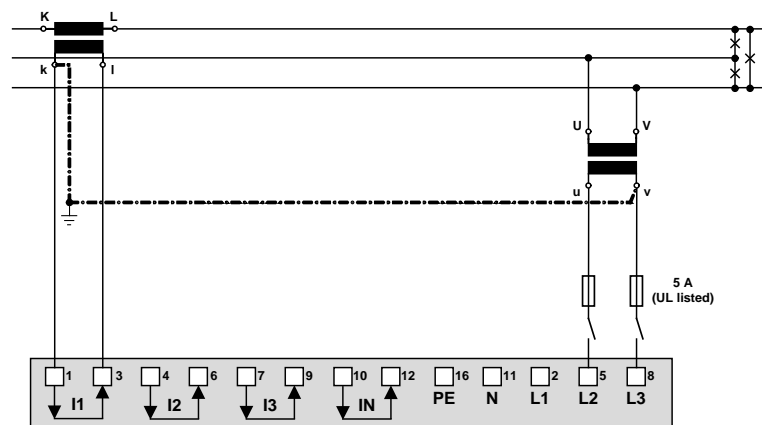

With current and voltage transformers

*In case of current measurement via L2 or L3 connect the device according to the following table:*

<b>Terminals</b>	<b>1</b>	<b>3</b>	<b>2</b>	<b>5</b>	<b>8</b>
Current meas. via L2	I2(k)	I2(l)	L2	L3	-
Current meas. via L3	I3(k)	I3(l)	L3	L1	-

**Three wire system, balanced load, phase shift**  
**current measurement: L1, voltage measurement: L2-L3**

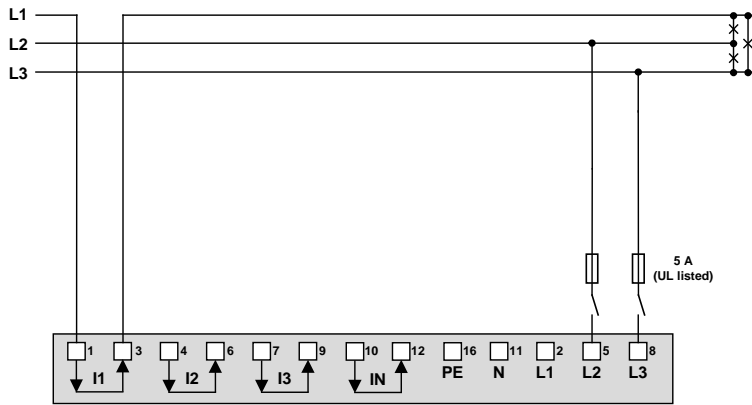

Direct connection

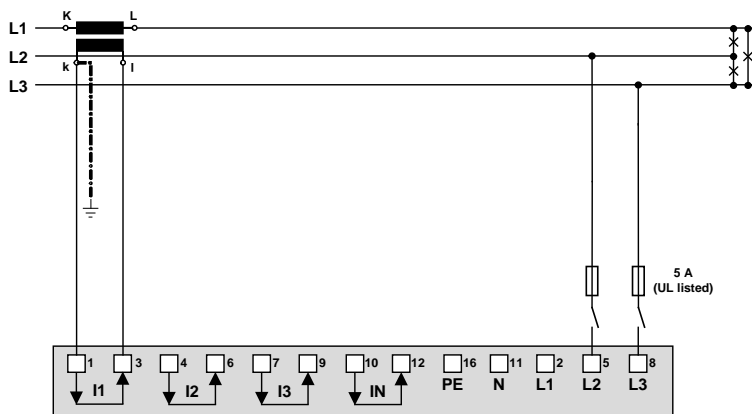

With current transformer

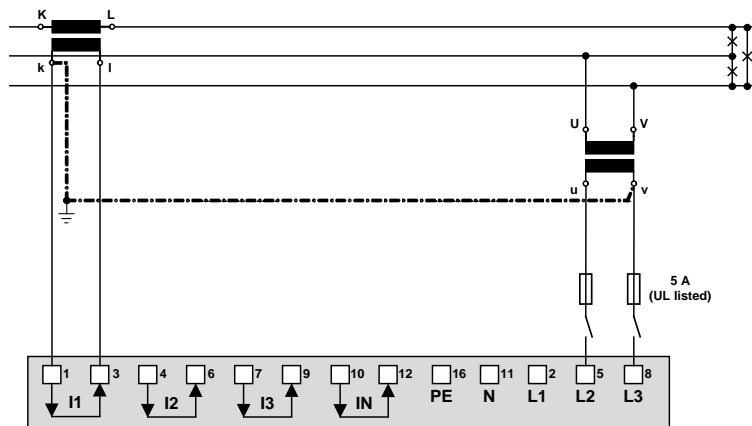

With current and voltage transformers

*In case of current measurement via L2 or L3 connect the device according to the following table:*

<b>Terminals</b>	<b>1</b>	<b>3</b>	<b>2</b>	<b>5</b>	<b>8</b>
Current meas. via L2	$I2(k)$	$I2(l)$	-	L3	L1
Current meas. via L3	$I3(k)$	$I3(l)$	-	L1	L2

**Three wire system, balanced load, phase shift**  
**current measurement: L1, voltage measurement: L3-L1**

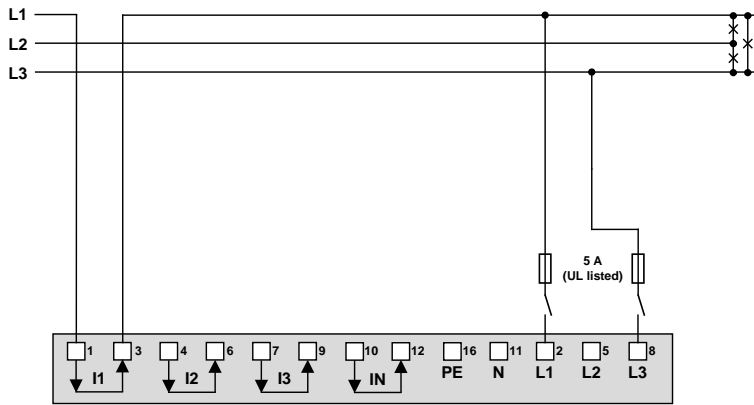

Direct connection

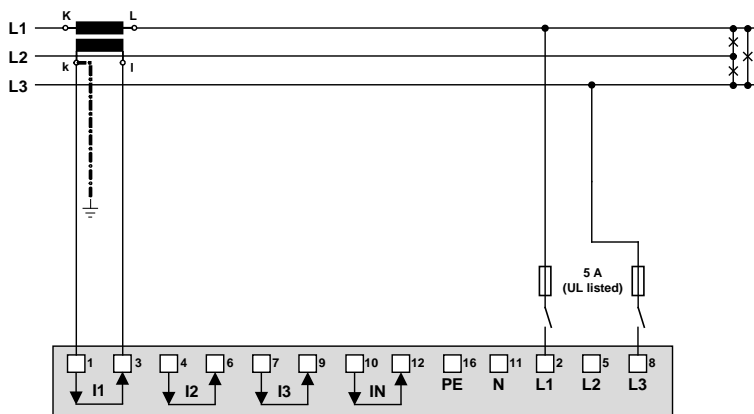

With current transformer

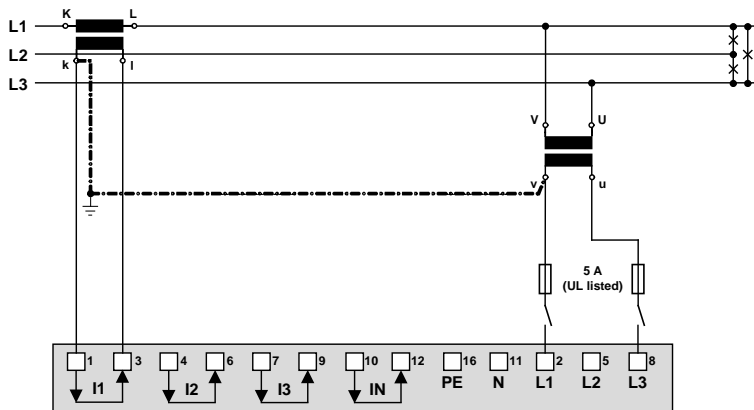

With current and voltage transformers

*In case of current measurement via L2 or L3 connect the device according to the following table:*

<b>Terminals</b>	<b>1</b>	<b>3</b>	<b>2</b>	<b>5</b>	<b>8</b>
Current meas. via L2	$I2(k)$	$I2(l)$	L2	-	L1
Current meas. via L3	$I3(k)$	$I3(l)$	L3	-	L2

### Three wire system, balanced load, current measurement via L1

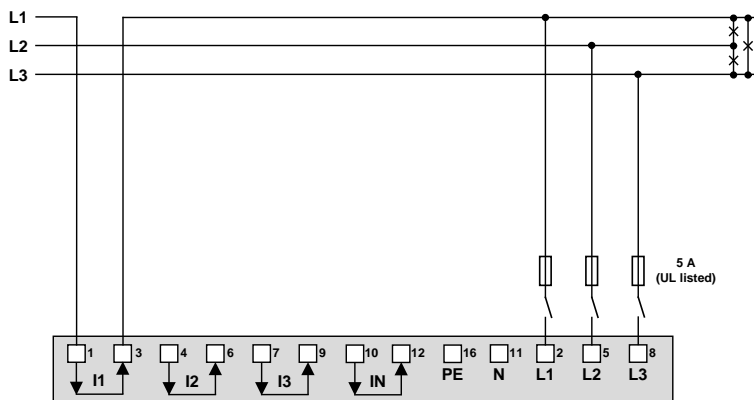

Direct connection

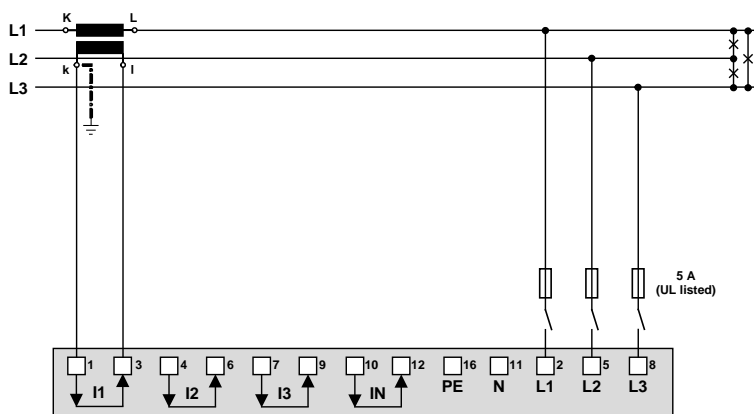

With current transformer

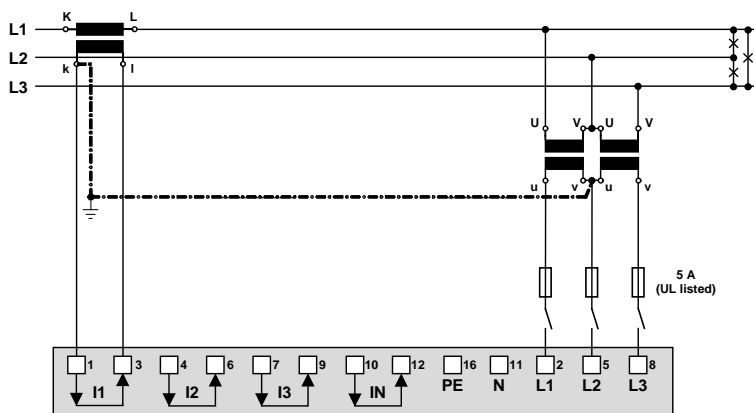

With current and voltage transformers

In case of current measurement via L2 or L3 connect the device according to the following table:

Terminals	1	3	2	5	8
Current meas. via L2	$I_2(k)$	$I_2(l)$	L2	L3	L1
Current meas. via L3	$I_3(k)$	$I_3(l)$	L3	L1	L2



By rotating the voltage connections the measurements  $U_{12}$ ,  $U_{23}$  and  $U_{31}$  will be assigned interchanged!

## Four wire system, balanced load, current measurement via L1

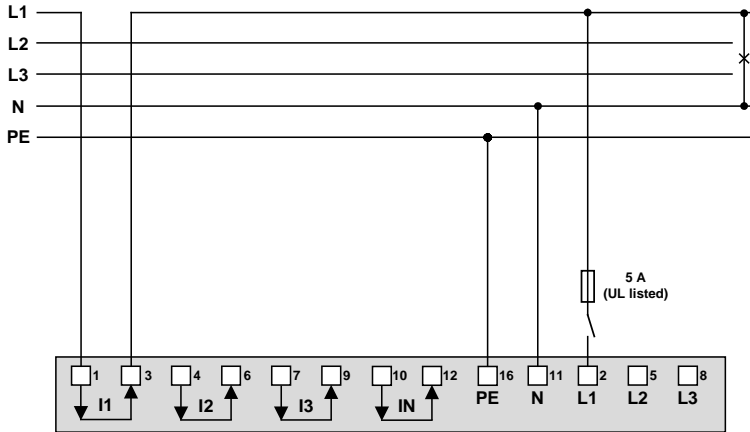

Direct connection

If voltage  $U_{NE}$  does not need to be measured, connection of PE can be omitted.

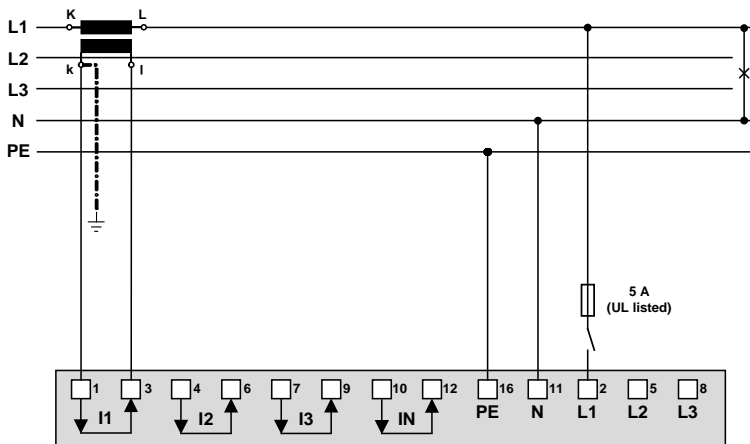

With current transformer

If voltage  $U_{NE}$  does not need to be measured, connection of PE can be omitted.

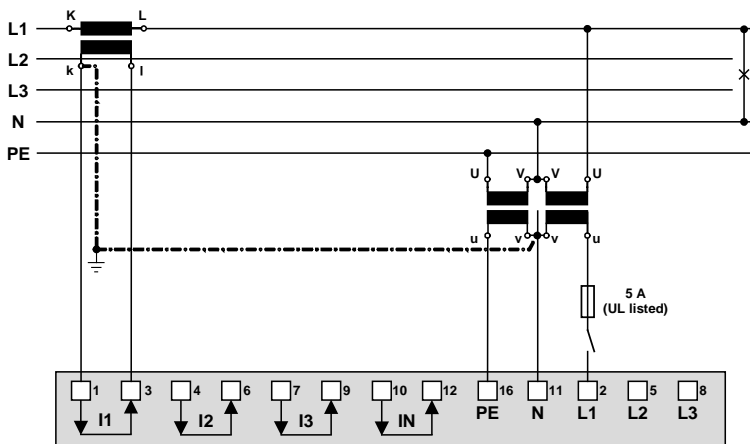

With current and voltage transformer

If voltage  $U_{NE}$  does not need to be measured, the corresponding transformer can be omitted.

In case of current measurement via L2 or L3 connect the device according to the following table:

Terminals	1	3	2	11
Current meas. via L2	$I2(k)$	$I2(l)$	L2	N
Current meas. via L3	$I3(k)$	$I3(l)$	L3	N



### Three wire system, unbalanced load

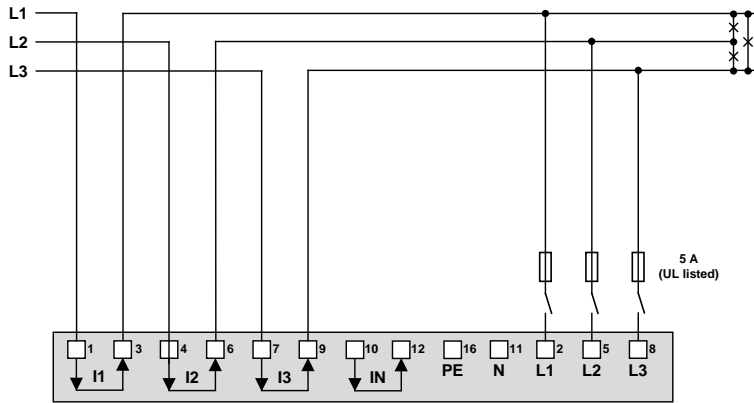

Direct connection

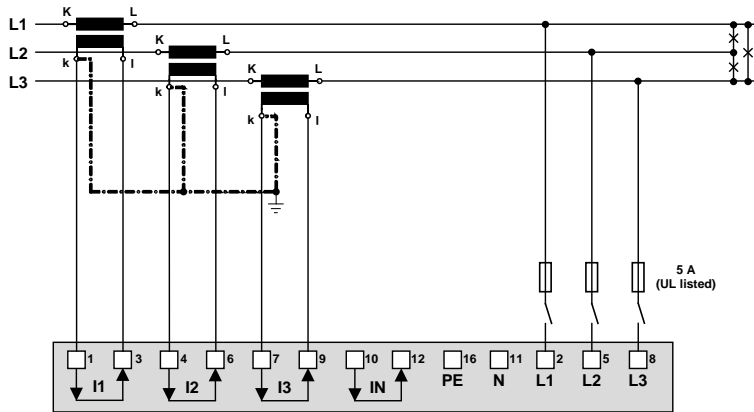

With current transformers

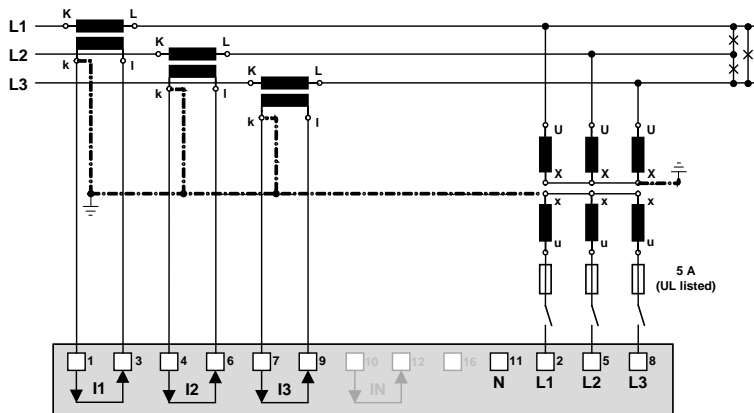

With current and 3 single-pole isolated voltage transformers

### Three wire system, unbalanced load, Aron connection

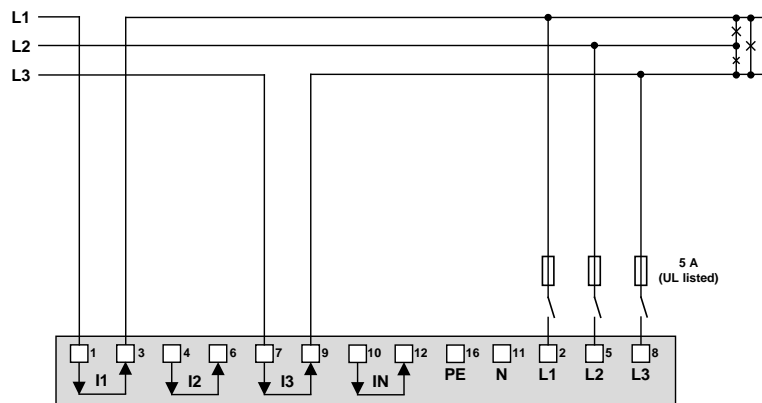

Direct connection

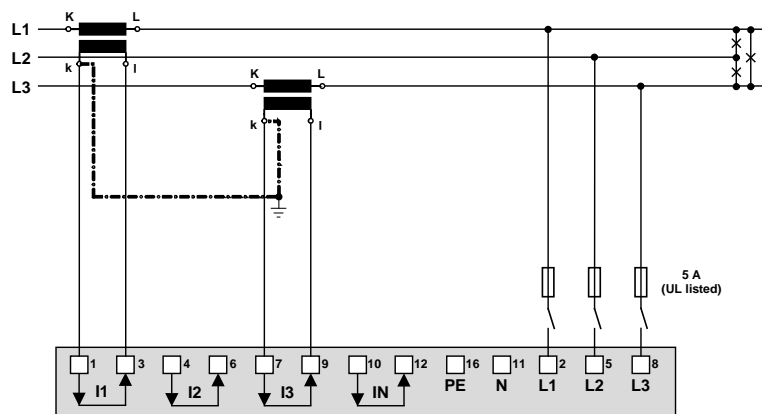

With current transformers

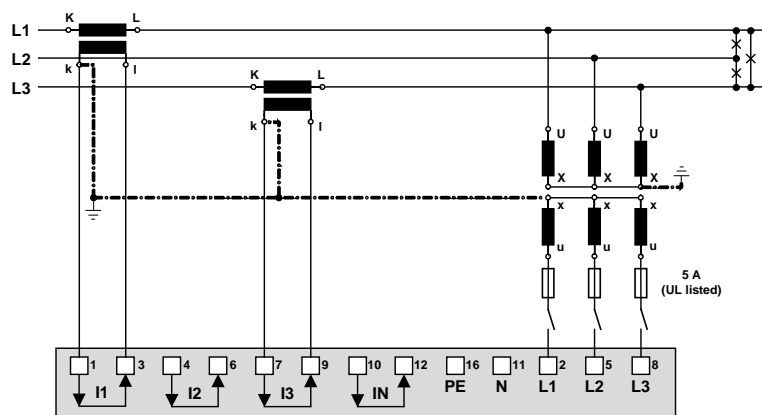

With current and 3 single-pole isolated voltage transformers

## Four wire system, unbalanced load

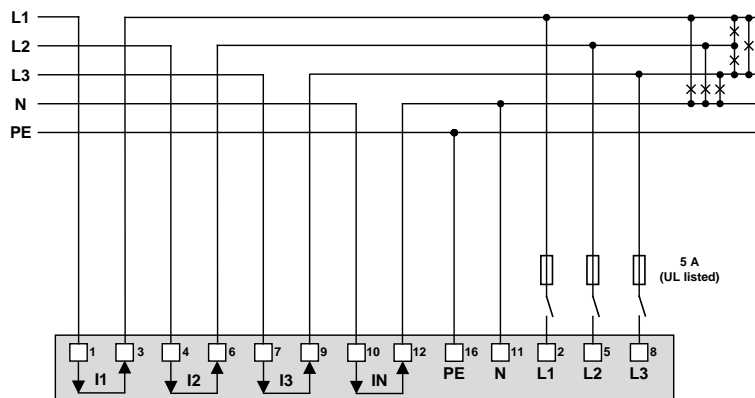

### Direct connection

If current  $I_N$  or voltage  $U_{NE}$  does not need to be measured, connection of  $I_N$  resp. PE can be omitted.

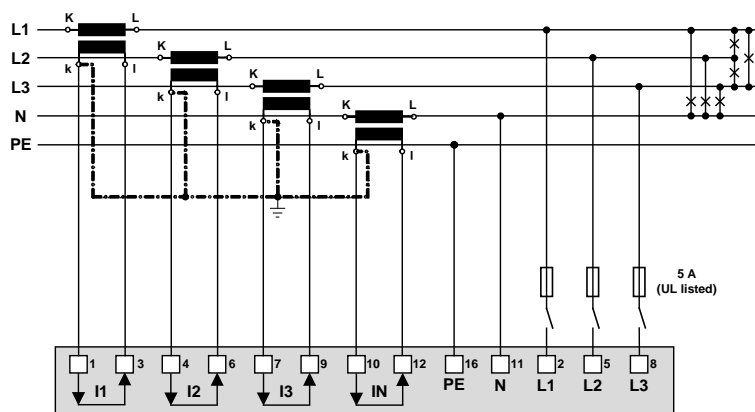

### With current transformer

If voltage  $U_{NE}$  does not need to be measured, connection of PE can be omitted.

If current  $I_N$  does not need to be measured, the corresponding transformer can be omitted.

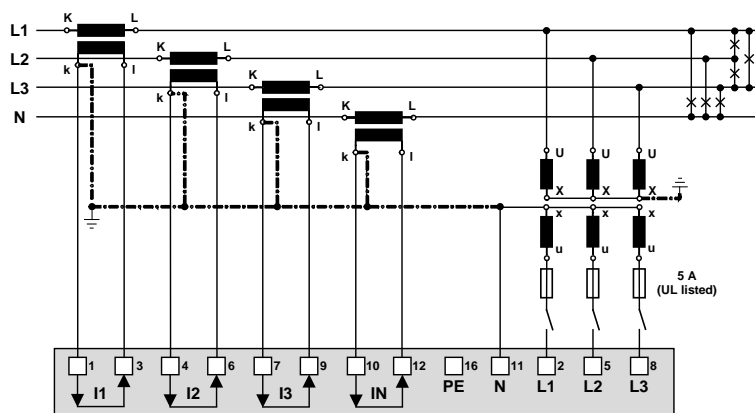

### With current and voltage transformer

If current  $I_N$  does not need to be measured, the corresponding transformer can be omitted.

## Four wire system, unbalanced load, Open-Y

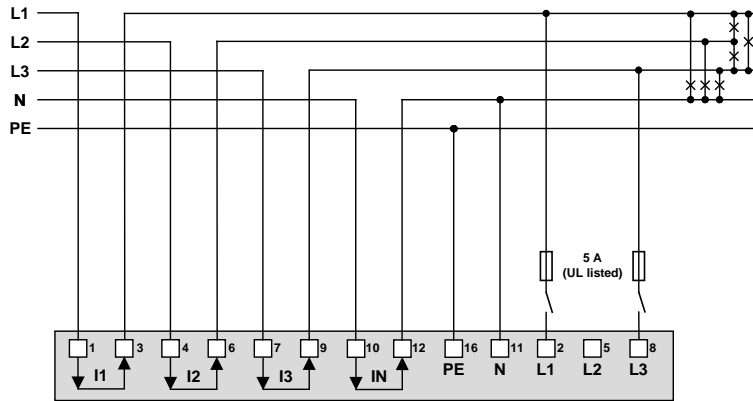

### Direct connection

If current  $I_N$  or voltage  $U_{NE}$  does not need to be measured, connection of  $I_N$  resp. PE can be omitted.

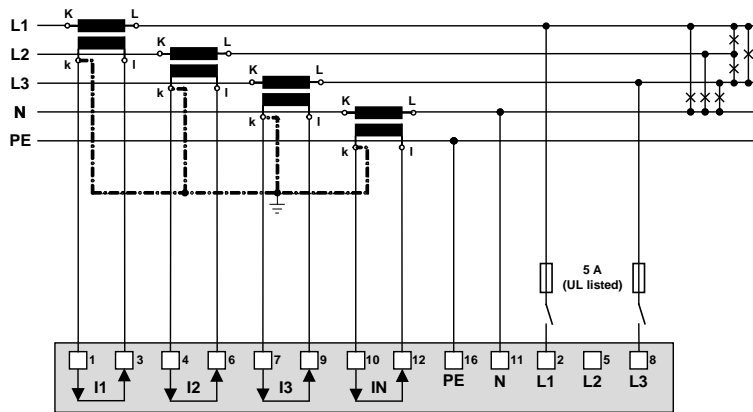

### With current transformer

If voltage  $U_{NE}$  does not need to be measured, connection of PE can be omitted.

If current  $I_N$  does not need to be measured, the corresponding transformer can be omitted.

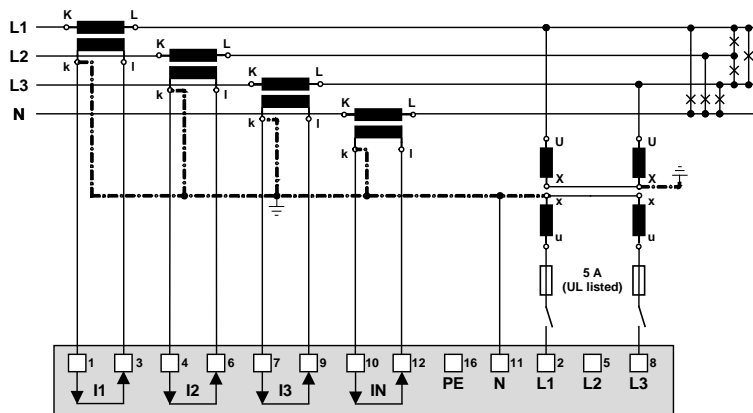

### With current and voltage transformer

If current  $I_N$  does not need to be measured, the corresponding transformer can be omitted.

## Split-phase ("two phase system"), unbalanced load

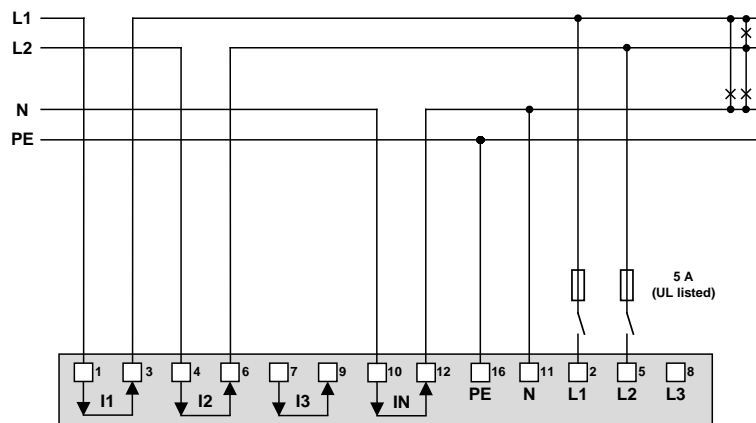

Direct connection

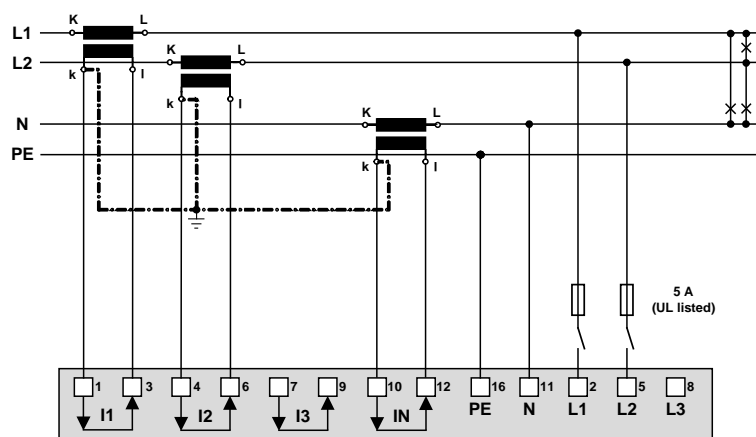

With current transformers

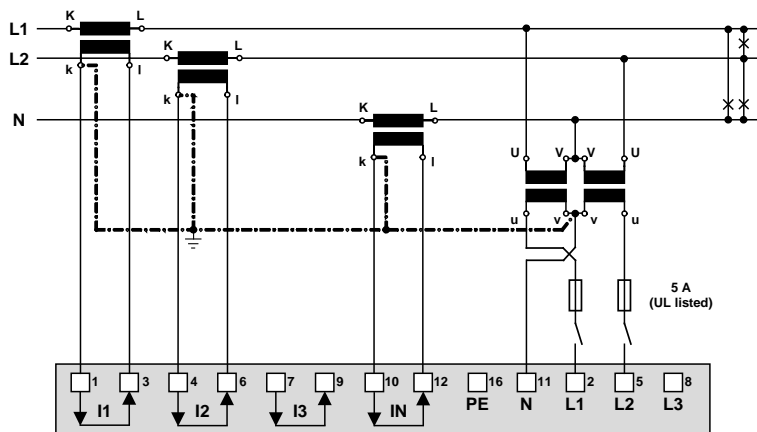

With current and voltage transformer

In systems without a primary neutral conductor a voltage transformer with a secondary center tap can also be used.

## 5.5 Power supply



A marked and easily accessible current limiting switch has to be arranged in the vicinity of the device for turning off the power supply. Fusing should be 10 Amps or less and must be rated for the available voltage and fault current.

## 5.6 Relays



When the device is switched off the relay contacts are de-energized, but dangerous voltages may be present.

Relays are available for device versions with corresponding I/O extensions only.

I/O extension y	x
1	5
2	6
3	4
4	3

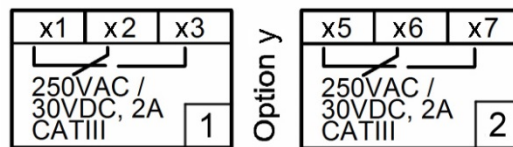

## 5.7 Digital inputs

The device provides a standard passive digital input. In addition, depending on the device version, there may be 4-channel passive or active digital input modules available.

### Usage of the standard digital input

- ▶ Synchronization of billing intervals in accordance with energy provider
- ▶ Meter tariff switching

### Usage of the inputs of the optional input modules

- ▶ Counting input for pulses of meters for any kind of energy (pulse width 30...250ms)
- ▶ Operating feedback of loads for operating time counters
- ▶ Trigger and release signal for monitoring functions

**Passive inputs** (external power supply with 12 / 24 VDC required)



The power supply shall not exceed 30V DC!

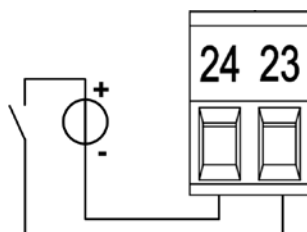
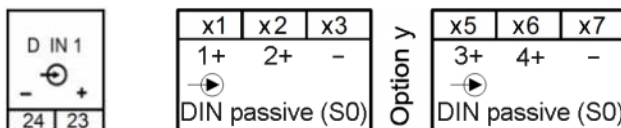

### Technical data

Input current	< 7,0 mA
Logical ZERO	- 3 up to + 5 V
Logical ONE	8 up to 30 V

**Active inputs** (no external power supply required)

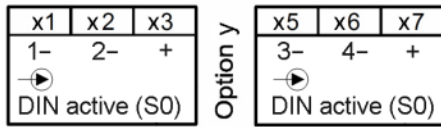

Example with meter pulse and status inputs

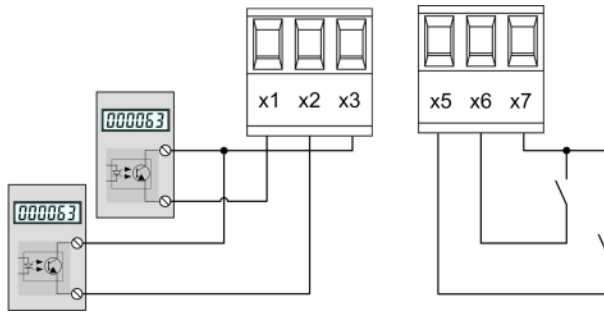

Technical data

- acc. EN62053-31, class B
- Open circuit voltage  $\leq 15\text{ V}$
- Short circuit current  $< 15\text{ mA}$
- Current at  $R_{ON}=800\Omega \geq 2\text{ mA}$

## 5.8 Digital outputs

The device has two standard digital outputs for which an external 12 / 24 VDC power supply is required.

The power supply shall not exceed 30V DC!

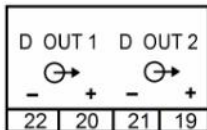

**Usage as digital output**

- ▶ Alarm output
- ▶ State reporting
- ▶ Pulse output to an external counter (acc. EN62053-31)
- ▶ Remote controlled output

1) Recommended if input impedance of counter  $> 100\text{ k}\Omega$

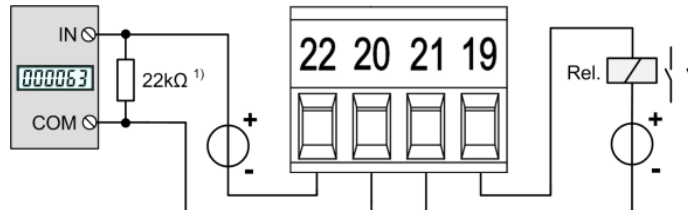

Driving a counter mechanism

The width of the energy pulses can be selected within a range of 30 up to 250ms, but have to be adapted to the external counter mechanism.

**Electro mechanical meters** typically need a pulse width of 50...100ms.

**Electronic meters** are partly capable to detect pulses in the kHz range. There are two types: NPN (active negative edge) and PNP (active positive edge). For this device a PNP is required. The pulse width has to be  $\geq 30\text{ms}$  (acc. EN62053-31). The delay between two pulses has to be at least the pulse width. The smaller the pulse width, the higher the sensitivity to disturbances.

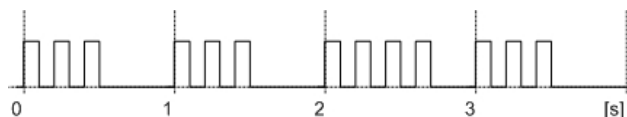

Driving a relay

- Rated current 50 mA (60 mA max.)
- Switching frequency (S0)  $\leq 20\text{ Hz}$
- Leakage current 0,01 mA
- Voltage drop  $< 3\text{ V}$
- Load capacity  $400\ \Omega \dots 1\text{ M}\Omega$

## 5.9 Analog outputs

Analog outputs are available for devices with corresponding I/O extensions only. See nameplate. Analog outputs may be remote controlled.

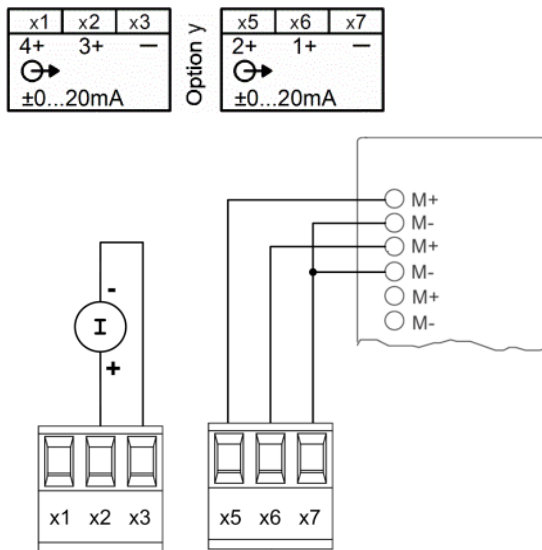

### Connection to an analog input card of a PLC or a control system

The device is an isolated measurement device. The module outputs are galvanically connected, but the modules isolated from each other. To reduce the influence of disturbances shielded a twisted-pair cables should be used. The shield should be connected to earth on both opposite ends. If there are potential differences between the ends of the cable the shield should be earthed on one side only to prevent from equalizing currents.

Under all circumstances consider as well appropriate remarks in the instruction manual of the system to connect.

## 5.10 Modbus interface RS485

Via the optional Modbus interface measurement data may be provided for a superior system. However, the Modbus interface cannot be used for device parameterization.

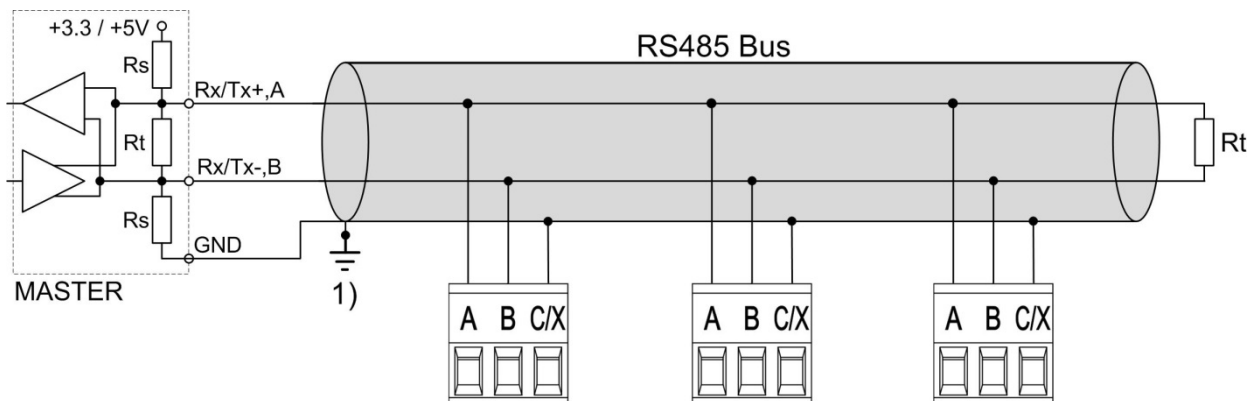

1) One ground connection only. This is possibly made within the master (PC).

Rt: Termination resistors: 120 Ω each for long cables (> approx. 10 m)

Rs: Bus supply resistors, 390 Ω each

The signal wires (A, B) have to be twisted. GND (C/X) can be connected via a wire or via the cable screen. In disturbed environments shielded cables must be used. Supply resistors (Rs) have to be present in bus master (PC) interface. Stubs should be avoided when connecting the devices. A pure line network is ideal.

You may connect up to 32 Modbus devices to the bus. A proper operation requires that all devices connected to the bus have equal communication settings (baud rate, transmission format) and unique Modbus addresses.

The bus system is operated half duplex and may be extended to a maximum length of 1200 m without repeater.



## 5.11 Uninterruptible power supply (UPS)

The [battery pack](#) for the uninterruptible power supply is supplied separately. Please note that compared to the storage temperature range of the base unit the [storage temperature range](#) of the battery pack is restricted.

Ensure that devices with uninterruptible power supply are used in an environment in accordance with the [specification](#). Outside this operating temperature range, it is not ensured that the battery pack is recharged.

Due to aging the capacity of the battery decreases. To ensure a successful operation of the device during power interruptions the battery needs to be replaced every 3 up to 5 years.



Potential for Fire or Burning. Do not disassemble, crush, heat or burn the removed battery pack.

Replace battery pack with a [battery pack of the same type](#) only. Use of another battery may present a risk of fire or explosion.

## 6. Commissioning



Before commissioning you have to check if the connection data of the device match the data of the plant (see nameplate).

If so, you can start to put the device into operation by switching on the power supply and the measurement inputs.

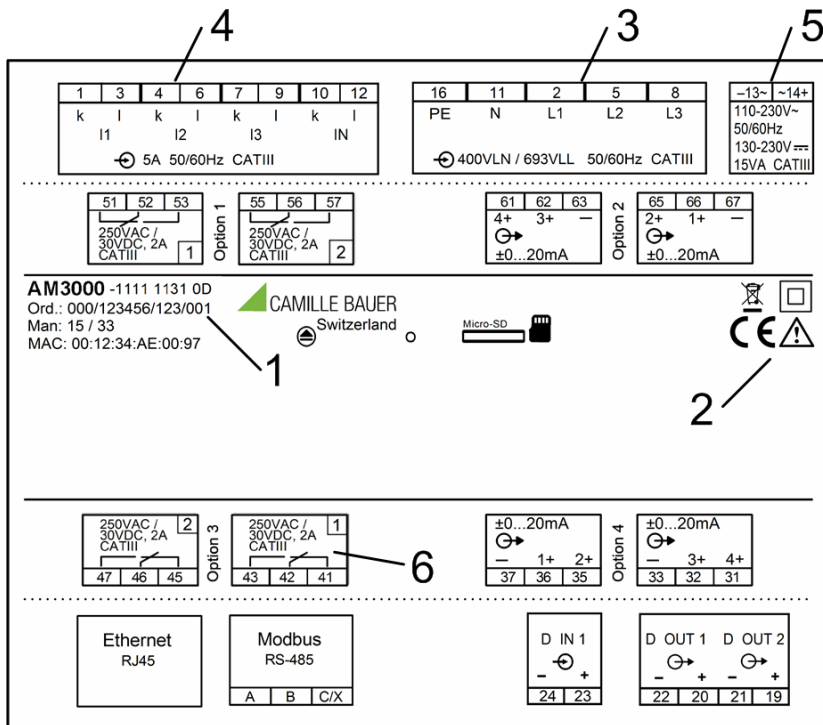

▶ Measurement input

Input voltage  
Input current  
System frequency

- 1 Works no.
- 2 Test and conformity marks
- 3 Assignment voltage inputs
- 4 Assignment current inputs
- 5 Assignment power supply
- 6 Load capacity relay outputs

### 6.1 Parametrization of the device functionality

A full parameterization of all functions of the device is possible directly at the device or via web browser.

See: [Configuration \(7.5\)](#)

## 6.2 Installation check

By means of the phasor diagram the correct connection of the current and voltage inputs can be checked. In this diagram a technical visualization of the current and voltage phasors is shown, using a counter-clockwise rotation, independent of the real sense of rotation.

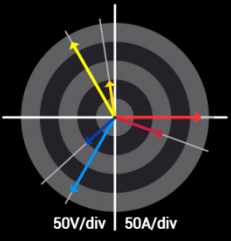
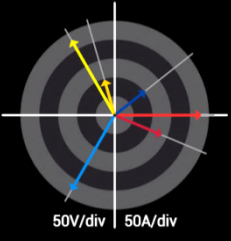
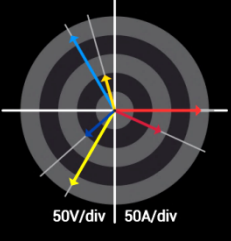
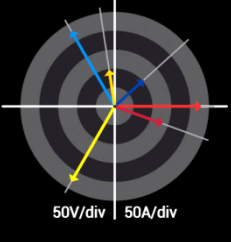
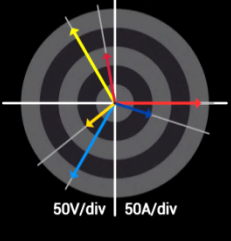

The diagram is always built basing on the voltage of the reference channel (direction 3 o'clock)

<p><b>Phasor diagram</b> <span style="float: right;">22.07.2015 17:38</span></p>  <table border="1" data-bbox="486 443 742 683"> <thead> <tr> <th>L1</th> <th>L2</th> <th>L3</th> <th></th> </tr> </thead> <tbody> <tr> <td>230.12</td> <td>230.30</td> <td>230.17</td> <td>V</td> </tr> <tr> <td>0.00</td> <td>-119.99</td> <td>120.00</td> <td>°</td> </tr> <tr> <td>135.83</td> <td>103.88</td> <td>98.02</td> <td>A</td> </tr> <tr> <td>-19.9</td> <td>-17.9</td> <td>-21.2</td> <td>°</td> </tr> <tr> <td>0.943</td> <td>0.954</td> <td>0.935</td> <td>PF</td> </tr> </tbody> </table> <p>50V/div   50A/div</p>	L1	L2	L3		230.12	230.30	230.17	V	0.00	-119.99	120.00	°	135.83	103.88	98.02	A	-19.9	-17.9	-21.2	°	0.943	0.954	0.935	PF	<p><b>Correct installation (expectation)</b></p> <ul style="list-style-type: none"> <li>Voltage sequence in clock-wise order: <b>L1 → L2 → L3</b> (<math>0^\circ \rightarrow -120^\circ \rightarrow 120^\circ</math>)</li> <li>Current sequence in clock-wise order: <b>L1 → L2 → L3</b></li> <li>Similar angle between voltage and current phasors in all phases (approx. <math>-20^\circ</math>)</li> </ul>
L1	L2	L3																							
230.12	230.30	230.17	V																						
0.00	-119.99	120.00	°																						
135.83	103.88	98.02	A																						
-19.9	-17.9	-21.2	°																						
0.943	0.954	0.935	PF																						
<p><b>Phasor diagram</b> <span style="float: right;">22.07.2015 17:13</span></p>  <table border="1" data-bbox="486 777 742 1016"> <thead> <tr> <th>L1</th> <th>L2</th> <th>L3</th> <th></th> </tr> </thead> <tbody> <tr> <td>230.15</td> <td>230.30</td> <td>230.18</td> <td>V</td> </tr> <tr> <td>0.00</td> <td>-120.00</td> <td>120.00</td> <td>°</td> </tr> <tr> <td>135.83</td> <td>103.89</td> <td>98.01</td> <td>A</td> </tr> <tr> <td>-22.8</td> <td>158.3</td> <td>-13.8</td> <td>°</td> </tr> <tr> <td>0.943</td> <td>-0.954</td> <td>0.935</td> <td>PF</td> </tr> </tbody> </table> <p>50V/div   50A/div</p>	L1	L2	L3		230.15	230.30	230.18	V	0.00	-120.00	120.00	°	135.83	103.89	98.01	A	-22.8	158.3	-13.8	°	0.943	-0.954	0.935	PF	<p><b>What's wrong?</b></p> <ul style="list-style-type: none"> <li>Voltage sequence: <b>L1 → L2 → L3</b></li> <li>Current sequence: <b>L1 → L3 → L2</b>; Current L2 is out of the expected sequence</li> <li>Angle U-I: Angle between <math>U_{L2}</math> and <math>I_{L2}</math> is approx. <math>180^\circ</math> wrong</li> </ul> <p><b>Required correction</b> Exchanging the connections of current <math>I_2</math></p>
L1	L2	L3																							
230.15	230.30	230.18	V																						
0.00	-120.00	120.00	°																						
135.83	103.89	98.01	A																						
-22.8	158.3	-13.8	°																						
0.943	-0.954	0.935	PF																						
<p><b>Phasor diagram</b> <span style="float: right;">22.07.2015 17:17</span></p>  <table border="1" data-bbox="486 1111 742 1350"> <thead> <tr> <th>L1</th> <th>L2</th> <th>L3</th> <th></th> </tr> </thead> <tbody> <tr> <td>230.16</td> <td>230.22</td> <td>230.29</td> <td>V</td> </tr> <tr> <td>0.00</td> <td>120.00</td> <td>-119.99</td> <td>°</td> </tr> <tr> <td>135.83</td> <td>103.88</td> <td>98.01</td> <td>A</td> </tr> <tr> <td>-24.6</td> <td>101.5</td> <td>-134.2</td> <td>°</td> </tr> <tr> <td>0.943</td> <td>-0.218</td> <td>-0.775</td> <td>PF</td> </tr> </tbody> </table> <p>50V/div   50A/div</p>	L1	L2	L3		230.16	230.22	230.29	V	0.00	120.00	-119.99	°	135.83	103.88	98.01	A	-24.6	101.5	-134.2	°	0.943	-0.218	-0.775	PF	<p><b>What's wrong?</b></p> <ul style="list-style-type: none"> <li>Voltage sequence: <b>L1 → L3 → L2</b>; L3 and L2 seem to be interchanged</li> <li>Current sequence: <b>L1 → L2 → L3</b></li> <li>Angle U-I: Angle between <math>U_{L2}</math> and <math>I_{L2}</math> is approx. <math>180^\circ</math> wrong</li> </ul> <p><b>Required correction</b> Exchanging the connections of the voltages L2 and L3</p>
L1	L2	L3																							
230.16	230.22	230.29	V																						
0.00	120.00	-119.99	°																						
135.83	103.88	98.01	A																						
-24.6	101.5	-134.2	°																						
0.943	-0.218	-0.775	PF																						
<p><b>Phasor diagram</b> <span style="float: right;">22.07.2015 17:16</span></p>  <table border="1" data-bbox="486 1444 742 1684"> <thead> <tr> <th>L1</th> <th>L2</th> <th>L3</th> <th></th> </tr> </thead> <tbody> <tr> <td>230.17</td> <td>230.19</td> <td>230.27</td> <td>V</td> </tr> <tr> <td>0.00</td> <td>120.00</td> <td>-120.00</td> <td>°</td> </tr> <tr> <td>135.85</td> <td>103.89</td> <td>98.00</td> <td>A</td> </tr> <tr> <td>-19.9</td> <td>-77.9</td> <td>-141.3</td> <td>°</td> </tr> <tr> <td>0.943</td> <td>0.217</td> <td>-0.775</td> <td>PF</td> </tr> </tbody> </table> <p>50V/div   50A/div</p>	L1	L2	L3		230.17	230.19	230.27	V	0.00	120.00	-120.00	°	135.85	103.89	98.00	A	-19.9	-77.9	-141.3	°	0.943	0.217	-0.775	PF	<p><b>What's wrong?</b></p> <ul style="list-style-type: none"> <li>Voltage sequence: <b>L1 → L3 → L2</b>; L3 and L2 seems to be exchanged</li> <li>Current sequence: <b>L1 → L3 → L2</b>; Current L2 is out of the expected sequence</li> <li>Angle U-I: Angles between <math>U_{L2} / I_{L2}</math> and <math>U_{L3} / I_{L3}</math> do not correspond to the expectations</li> </ul> <p><b>Required correction</b> Exchanging the connections of the voltages L2 and L3 and reversing the polarity of the current input <math>I_2</math></p>
L1	L2	L3																							
230.17	230.19	230.27	V																						
0.00	120.00	-120.00	°																						
135.85	103.89	98.00	A																						
-19.9	-77.9	-141.3	°																						
0.943	0.217	-0.775	PF																						
<p><b>Phasor diagram</b> <span style="float: right;">22.07.2015 17:18</span></p>  <table border="1" data-bbox="486 1778 742 2018"> <thead> <tr> <th>L1</th> <th>L2</th> <th>L3</th> <th></th> </tr> </thead> <tbody> <tr> <td>230.20</td> <td>230.26</td> <td>230.17</td> <td>V</td> </tr> <tr> <td>0.00</td> <td>-119.99</td> <td>120.02</td> <td>°</td> </tr> <tr> <td>135.83</td> <td>103.87</td> <td>98.02</td> <td>A</td> </tr> <tr> <td>100.1</td> <td>102.1</td> <td>98.7</td> <td>°</td> </tr> <tr> <td>-0.183</td> <td>-0.218</td> <td>-0.160</td> <td>PF</td> </tr> </tbody> </table> <p>50V/div   50A/div</p>	L1	L2	L3		230.20	230.26	230.17	V	0.00	-119.99	120.02	°	135.83	103.87	98.02	A	100.1	102.1	98.7	°	-0.183	-0.218	-0.160	PF	<p><b>What's wrong?</b></p> <ul style="list-style-type: none"> <li>Voltage sequence: <b>L1 → L2 → L3</b></li> <li>Current sequence: <b>L2 → L3 → L1</b></li> <li>Angle U-I: The U-I angles do not correspond to the expectation, but are similar</li> </ul> <p><b>Required correction</b> Cyclical exchange of the voltage connections: <math>L1 \rightarrow L3</math>, <math>L2 \rightarrow L1</math>, <math>L3 \rightarrow L2</math>. As an alternative the sequence of all current may be changed as well (more effort required).</p>
L1	L2	L3																							
230.20	230.26	230.17	V																						
0.00	-119.99	120.02	°																						
135.83	103.87	98.02	A																						
100.1	102.1	98.7	°																						
-0.183	-0.218	-0.160	PF																						

### 6.3 Simulation of I/Os

To check if subsequent circuits will work properly with the measurement data provided by the device, using the service menu all analog, digital and relay outputs may be simulated, by predefining any output value resp. discrete state.

### 6.4 Ethernet installation

#### 6.4.1 Settings

Before devices can be connected to an existing Ethernet network, you have to ensure that they will not disturb the normal network service. The rule is:



**None of the devices to connect is allowed to have the same IP address than another device already installed**

The factory setting of the IP address is: 192.168.1.101

The settings of the Ethernet interface can be performed via the menu Settings | Communication | Ethernet.

The following settings have to be arranged with the network administrator:

- **IP address:** This one must be **unique**, i.e. may be assigned in the network only once.
- **Subnet mask:** Defines how many devices are directly addressable in the network. This setting is equal for all the devices.
- **Default gateway:** Is used to resolve addresses during communication between different networks. It should contain a valid address within the directly addressable network.
- **Hostname:** Individual designation for each device. Via the hostname the device can be uniquely identified in the network. Therefore for each device a unique name should be assigned.

For a direct communication between device and PC both devices need to be in the same network when the subnet mask is applied:

Example 1	decimal	binary
IP address	192.168. 1.101	11000000 10101000 00000001 01100101
Subnet mask	255.255.255.224	11111111 11111111 11111111 11100000
	variable range	xxxxxx
First address	192.168. 1. 96	11000000 10101000 00000001 01100000
Last address	192.168. 1.127	11000000 10101000 00000001 01111111

► The device 192.168.1.101 can access directly the devices 192.168.1.96 ... 192.168.1.127

Example 2	decimal	binary
IP address	192.168. 57. 64	11000000 10101000 00111001 01000000
Subnet mask	255.255.252. 0	11111111 11111111 11111100 00000000
	variable range	xx xxxxxxxx
First address	192.168. 56. 0	11000000 10101000 00111000 00000000
Last address	192.168. 59.255	11000000 10101000 00111011 11111111

► The device 192.168.57.64 can access directly the devices 192.168.56.0 ... 192.168.59.255

## DHCP

If a DHCP server is available, alternatively the mode „**DHCP**“ or „**DHCP, addresses only**“ can be selected. The device then gets all necessary information from the DHCP server. The difference between the two modes is that for „**DHCP**“ also the DNS server address is obtained.

The settings obtained from the DHCP server can be retrieved locally via the service menu. Please keep in mind, that when using the web browser you need to know the IP address in advance to establish a connection.

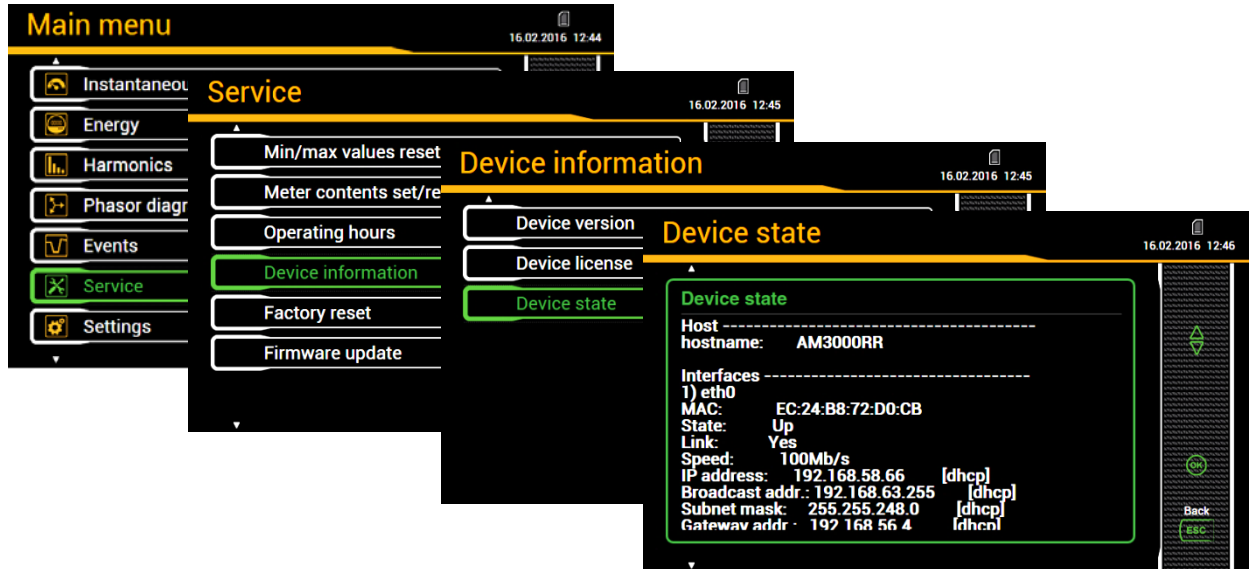

Depending on the settings of the DHCP server the provided IP address can change on each reboot of the device. Thus it's recommended to use the DHCP mode during commissioning only.

## Time synchronization via NTP protocol

For the *time synchronization* via Ethernet *NTP* (Network Time Protocol) is the standard. Corresponding time servers are used in computer networks, but are also available for free via Internet. Using NTP it's possible to hold all devices on a common time base.

Two different NTP servers may be defined. If the first server is not available the second server is used for trying to synchronize the time. If no time synchronization is desired, assign the address 0.0.0.0 to both NTP servers.

If a public NTP server is used, e.g. "pool.ntp.org", a name resolution is required. This normally happens via a **DNS server**. So, the IP address of the DNS server must be set in the communication settings of the Ethernet interface to make a communication with the NTP server possible - and thus time synchronization. Your network administrator can provide you the necessary information.

## TCP ports

The TCP communication is done via so-called ports. The number of the used port allows determining the type of communication. As a standard Modbus/TCP communication is performed via TCP port 502, NTP uses port 123. However, the port for the Modbus/TCP telegrams may be modified. You may provide a unique port to each of the devices, e.g. 503, 504, 505 etc., for an easier analysis of the telegram traffic. The setting of the Modbus TCP port is done as shown above. Independent of these setting a communication via port 502 is always supported. The device allows at least 5 connections to different clients at the same time.

## Firewall

Due to security reasons nowadays each network is protected by means of a firewall. When configuring the firewall you have to decide which communication is desired and which have to be blocked. The TCP port 502 for the Modbus/TCP communication normally is considered to be unsafe and is very often disabled. This may lead to a situation where no communication between networks (e.g. via Internet) is possible.

### 6.4.2 Connection

The standard RJ45 connector serves for direct connecting an Ethernet cable.

- Interface: RJ45 connector, Ethernet 100BaseTX
- Mode: 10/100 MBit/s, full / half duplex, Auto-negotiation
- Protocols: http, Modbus/TCP, NTP

#### Functionality of the LED's

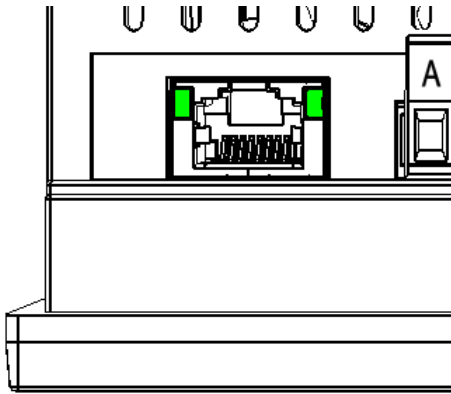

#### *LED right (green)*

- Switched on as soon as a network connection exists (link)

#### *LED left (green)*

- Switched-on during communication with the device (activity)

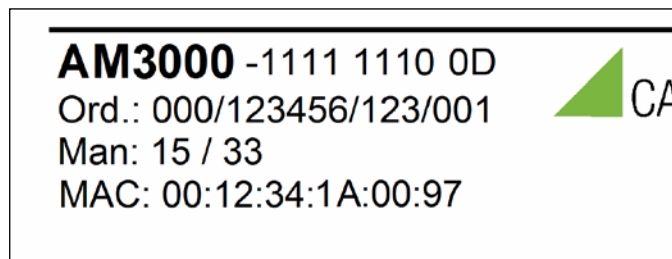

To have a unique identification of Ethernet devices in a network, to each connection a unique MAC address is assigned. This address is given on the nameplate, in the example: 00:12:34:1A:00:97.

Compared to the IP address, which may be modified by the user at any time, the MAC address is statically.

## 6.5 Protection against device data changing





Configuration or measurement data stored in the device may be modified via either service or settings menu. To protect these data a security system may be activated (default: not activated). If the security system is active the user has to enter a password before executing protected functions. Subsequent to a successful password input the access remains open until the user leaves the settings / service menu or an input timeout occurs.

For activating the security system a password input is required. The factory default is: "1234".



The password can be modified by the user. Permitted characters are 'a'...'z', 'A'...'Z' and '0'...'9', length 4...12 characters.

**ATTENTION:** A reset to factory default will reset also the password. But for a factory reset the present password needs to be entered. If this password is no longer known the device must be sent back to the factory!

Representation	Security system active	Security system deactivated / inactive
Device display		
Webpage		

## 7. Operating the device

### 7.1 Operating elements

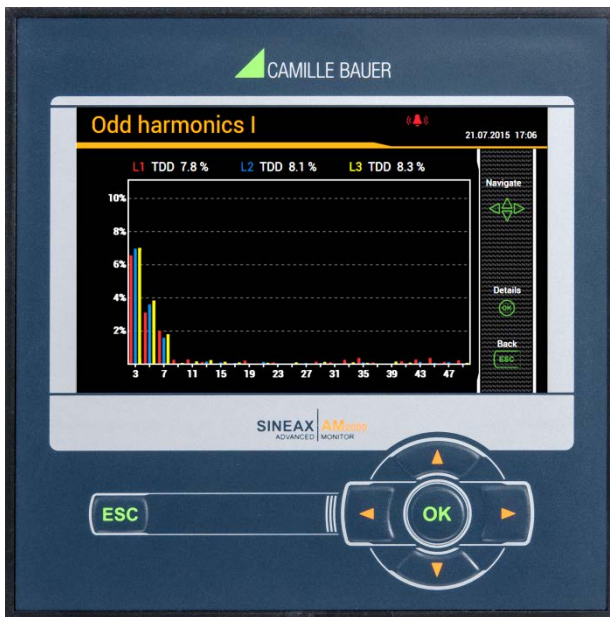

Operation is performed by means of 6 keys:

- 4 keys for **navigation** (◀, ▲, ▼, ▶) and for the selection of values
- OK for **selection** or confirmation
- ESC for **menu display**, terminate or cancel

The **function** of the operating keys changes in some measurement displays, during parameterization and in service functions. The valid functionality of the keys is then shown in a help bar.

### 7.2 Selecting the information to display



Information selection is performed via menu. Menu items may contain further sub-menus.

#### Displaying the menu

Press **ESC**. Each time the key is pressed a change to a higher menu level is performed, if present.

#### Displaying information

The menu item chosen using ▲, ▼ can be selected using **OK**. Repeat the procedure in possible submenus until the required information is displayed.

#### Return to measurement display

After 2 min. without interaction the menu is automatically closed and the last active measurement display is shown.



### 7.3 Measurement displays and used symbols

For displaying measurement information the device uses both numerical and numerical-graphical measurement displays.

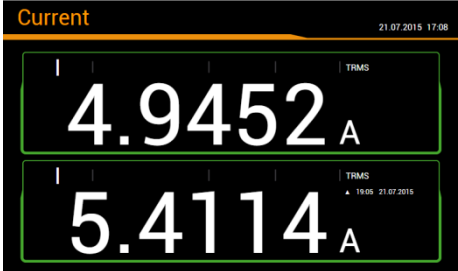
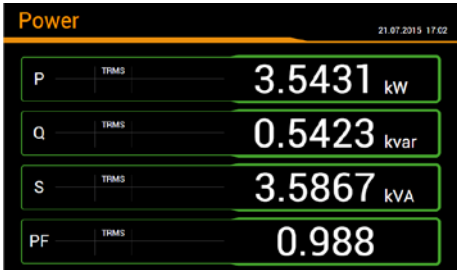
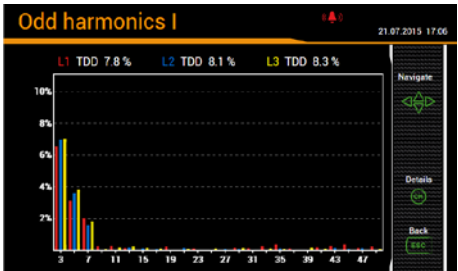
Examples	Measurement information
 <p>The image shows a digital display titled 'Current' with a timestamp of 21.07.2015 17:06. It displays two current measurements in Amperes (A): 4.9452 A and 5.4114 A. Each value is accompanied by a 'TRMS' label and a small bar graph indicator.</p>	2 measured quantities
 <p>The image shows a digital display titled 'Power' with a timestamp of 21.07.2015 17:02. It displays four power-related measurements: Active Power (P) 3.5431 kW, Reactive Power (Q) 0.5423 kvar, Apparent Power (S) 3.5867 kVA, and Power Factor (PF) 0.988. Each value is accompanied by a 'TRMS' label and a small bar graph indicator.</p>	4 measured quantities
 <p>The image shows a digital display titled 'User mean-values 1-4' with a timestamp of 27.07.2015 11:27. It displays eight mean values for four phases (1N, 2N, 3N, 4N). For each phase, it shows voltage (U) and current (I) values. For example, Phase 1N shows U 98.53 V and I 98.55 A. Each value is accompanied by a 'TRMS' label and a small bar graph indicator.</p>	2x4 measured quantities
 <p>The image shows a digital display titled 'Voltage min/max' with a timestamp of 21.07.2015 17:01. It displays eight values for voltage (U) and frequency (F) with minimum and maximum values. For example, U 12 shows a range from 410.67 V to 312.34 V. Each value is accompanied by a 'TRMS' label and a small bar graph indicator.</p>	2x4 measured quantities with min/max
 <p>The image shows a digital display titled 'Odd harmonics I' with a timestamp of 21.07.2015 17:06. It displays a bar chart showing the Total Harmonic Distortion (TDD) for three phases: L1 (7.8%), L2 (8.1%), and L3 (8.3%). The chart shows the percentage of distortion across various harmonic orders (3, 5, 7, 9, 11, 13, 15, 17, 19, 21, 23, 25, 27, 29, 31, 33, 35, 37, 39, 41, 43, 45, 47). The display also includes navigation buttons: 'Navigate', 'Details', 'Back', and 'ESC'.</p>	Graphical measurement display <a href="#">Further examples</a>

## Incoming / outgoing / inductive / capacitive





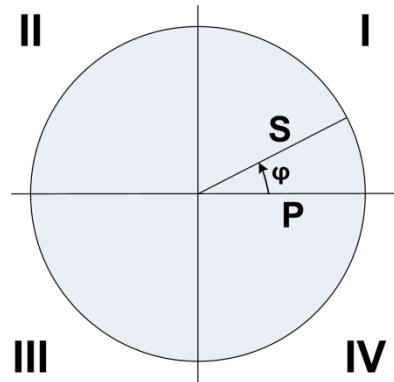

The device provides information for all four quadrants. Quadrants are normally identified using the roman numbers I, II, III and IV, as shown in the adjacent graphic. Depending on whether the system is viewed from the producer or consumer side, the interpretation of the quadrants is changing: The energy built from the active power in the quadrants I+IV can either be seen as delivered or consumed active energy.

By avoiding terms like incoming / outgoing energy and inductive or capacitive load when displaying data, an independent interpretation of the 4-quadrant information becomes possible. Instead the quadrant numbers I, II, III or IV, a combination of them or an appropriate graphical representation is used. You can select your own point of view by selecting the reference arrow system (load or generator) in the settings of the measurement.



## Used symbols

For defining a measurement uniquely, a short description (e.g.  $U_{1N}$ ) and a unit (e.g. V) are often not sufficient. Some measurements need further information, which is given by one of the following symbols or a combination of these symbols:

	Mean-value	$\Sigma HT$	Meter (high tariff)
	Mean-value trend	$\Sigma LT$	Meter (low tariff)
	Bimetal function (current)	$\blacktriangle$	Maximum value
	Energy quadrants I+IV	$\blacktriangledown$	Minimum value
	Energy quadrants II+III	TRMS	True root-mean-square value
	Energy quadrants I+II	RMS	Root-mean square value (e.g. fundamental or harmonic content only)
	Energy quadrants III+IV	(H1)	Fundamental component only
<b>I,II,III,IV</b>	Quadrants	$\emptyset$	Average (of RMS values)

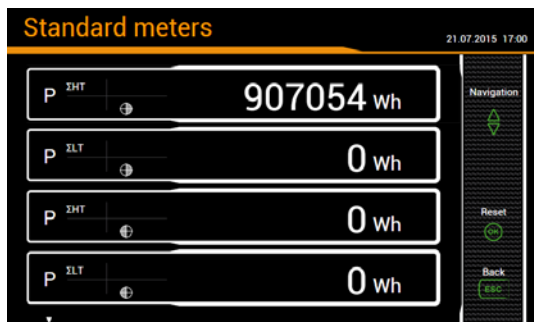

Meters with tariff and quadrant information

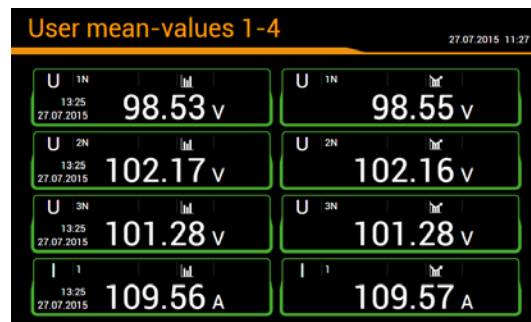

User mean values: Last value and trend

## 7.4 Resetting measurement data

- Minimum and maximum may be reset during operation. The reset may be performed in groups using the service menu.

Group	Values to be reset
1	Min/max values of voltages, currents and frequency
2	Min/max values of Power quantities (P,Q,Q(H1),D,S); min. load factors
3	Min/max values of power mean-values, bimetal slave pointers and free selectable mean-values
4	Maximum values of harmonic analysis: THD U/I, TDD I, individual harmonics U/I
5	All imbalance maximum values of voltage and current

- Meter contents may be individually set or reset during operation using the service menu
- Recorded logger data can be individually reset via the service menu. This makes sense whenever the configuration of the quantities to record has been changed.

## 7.5 Configuration

### 7.5.1 Configuration at the device

A full parameterization of the device can be performed via the menu “Settings”. With the exception of the “Country and clock” menu, all modifications will not take effect before the user accepts the query “Store configuration changes” when leaving the settings menu.



- **Country and clock:** time/date, time zone, date format, display language
- **Display:** Refresh rate, brightness, screen saver
- **Communication:** Settings of the communication interfaces [Ethernet](#) and [Modbus/RTU](#)
- **Measurement:** System type, sense of rotation, nominal values of U / I / f, sampling, reference arrow system etc.

#### Hints

- *U / I transformer: The primary to secondary ratio is used only for converting the measured secondary to primary values, so e.g. 100 / 5 is equivalent to 20 / 1. The values do not have any influence on the display format of the measurements.*
- *Nominal voltage / current: Used only as reference values, e.g. for scaling the harmonic content [TDD](#) of the currents*
- *Maximum primary values U/I: These values are used for fixing the display format of the measurements. This way you can optimize the resolution of the displayed values, because there is no dependency to installed transformers.*
- *Synchronous sampling: yes=sampling is adjusted to the measured system frequency to have a constant number of samplings per cycle; no=constant sampling based on the selected system frequency*
- *Reference channel: The measurement of the system frequency is done via the selected voltage or current input*
- **Mean-values | standard quantities:** Interval time and synchronization source for the predefined power mean values
- **Mean-values | user defined quantities:** Selection of up to 12 quantities for determining their mean-values and selection of their common interval and synchronization source
- **Bimetal current:** Selection of the response time for determining [bimetal currents](#)
- **Meters | Standard meters:** Tariff switching ON/OFF, [meter resolution](#)
- **Meters | User defined meters:** Base quantities (Px,Qx,Q(H1)x,Sx,Ix), Tariff switching ON/OFF, [meter resolution](#)
- **Meters | Meter logger:** Selection of the reading interval
- **Limit values:** Selection of up to 12 quantities to monitor, [limit values](#) for ON/OFF

- **Digital inputs:** Debounce time (minimum pulse width) and polarity of the [digital input](#)
- **Monitoring functions:** Definition of up to 8 [monitoring functions](#) with up to three inputs each, delay times for ON / OFF and description text
- **Summary alarm:** Selection of the monitoring functions to be used for triggering the [summary alarm](#) and selection of a possible source for resetting
- **Operating hours:** Selection of the running condition for up to 3 operating hour counters
- **Digital outputs | Digital output:** State, pulse or remote controlled [digital output](#) with source, pulse width, polarity, number of pulses per unit
- **Digital outputs | Relay:** State or remote controlled relay output with source
- **Analog outputs:** Type of output, source, transfer characteristic, upper/lower range limit
- **Security system:** Definition of password and password protection active/inactive
- **Demo mode:** Activation of a presentation mode; measurement data will be simulated. Demo mode is automatically stopped when rebooting the device.
- **Device tag:** Input of a free text for describing the device

## 7.5.2 Configuration via web browser

	It's recommended to use either Google-Chrome or Firefox as browser.
	Internet Explorer works with limitations only (partly missing texts, firmware update not possible)

For configuration via web browser use the device homepage via `http://<ip_addr>`. The default IP address of the device is 192.168.1.101.

This request works only if device and PC are in the same network when applying the subnet mask ([examples](#)).

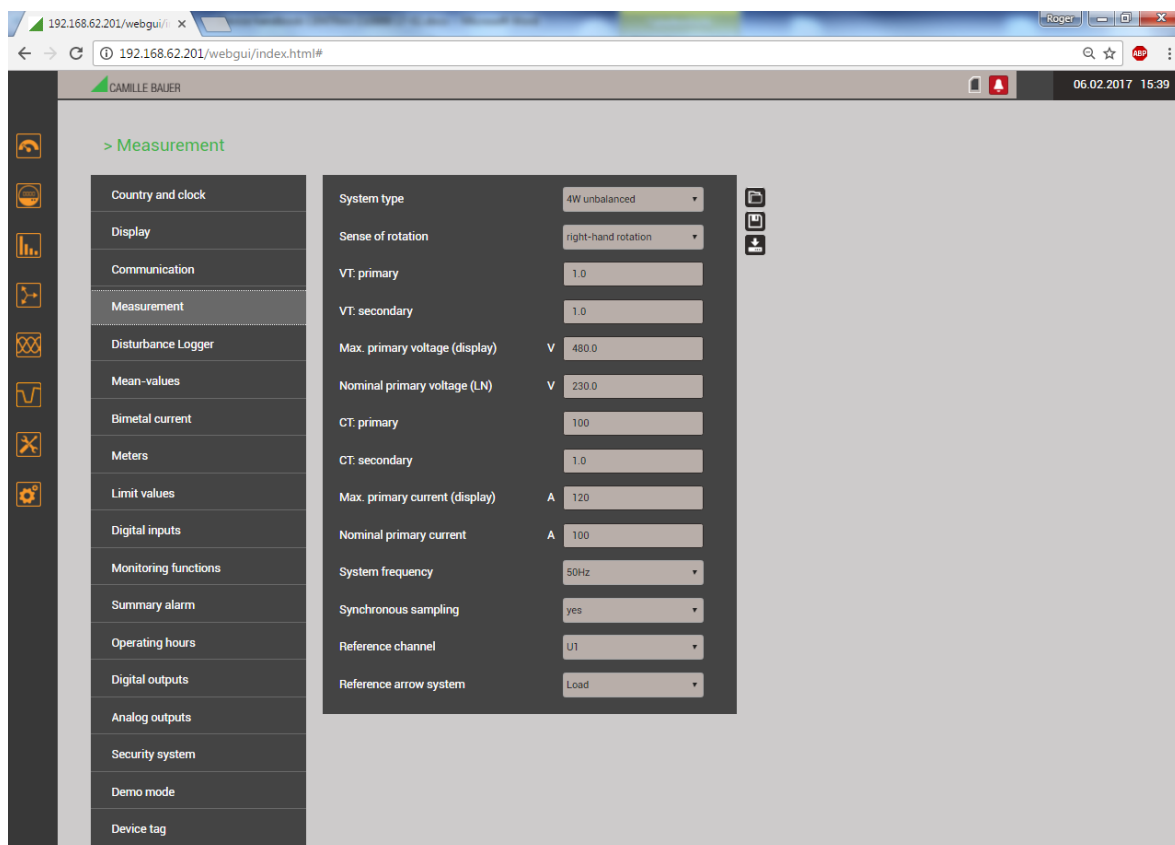

The screenshot shows a web browser window with the address bar displaying `192.168.62.201/webgui/index.html#`. The browser's address bar also shows the IP address `192.168.62.201/webgui/`. The page content is titled `> Measurement` and includes a sidebar with navigation icons. The main content area displays the following configuration fields:

Country and clock	System type	4W unbalanced
Display	Sense of rotation	right-hand rotation
Communication	VT: primary	1.0
Measurement	VT: secondary	1.0
Disturbance Logger	Max. primary voltage (display)	V 480.0
Mean-values	Nominal primary voltage (LN)	V 230.0
Bimetal current	CT: primary	100
Meters	CT: secondary	1.0
Limit values	Max. primary current (display)	A 120
Digital inputs	Nominal primary current	A 100
Monitoring functions	System frequency	50Hz
Summary alarm	Synchronous sampling	yes
Operating hours	Reference channel	U1
Digital outputs	Reference arrow system	Load
Analog outputs		
Security system		
Demo mode		
Device tag		

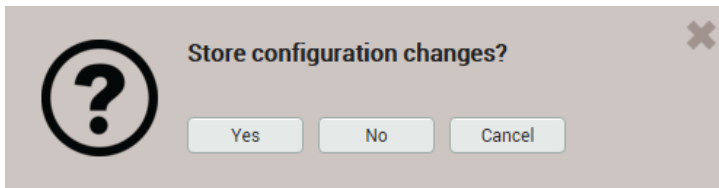

Via WEB-GUI all device settings can be performed as via the local GUI. Possibly modifications needs to be saved in the device, before all parameters have been set. In such a case the following message appears:



If this request is not confirmed unsaved modifications of the present device configuration may get lost.

### Loading / saving configuration files

The user can save the present device configuration on a storage media and reload it from there. The storage or load procedure varies depending on the used browser.

	<p><b>Loading a configuration file from a storage media</b></p> <p>The configuration data of the selected file will be directly loaded into the device. The values in the WEB-GUI will be updated accordingly. Normally devices differ in the settings of network resp. Modbus parameters and device name. Thus when loading the file you can choose, whether the appropriate settings of the device should be retained or overwritten by the values in the file to be uploaded.</p> <div data-bbox="485 931 1305 1323" style="border: 1px solid gray; padding: 10px; margin: 10px auto; width: fit-content;"> <p style="text-align: center;"><b>You are going to overwrite the device configuration!</b></p> <p style="text-align: center;">Do you really want to upload a new configuration?</p> <div style="display: flex; justify-content: space-between;"> <div style="width: 60%;"> <p>Device tag</p> <p>Ethernet</p> <p>RS-485 Modbus/RTU</p> <p>Security system</p> </div> <div style="width: 35%;"> <p><input type="checkbox"/> overwrite</p> <p><input type="checkbox"/> overwrite</p> <p><input type="checkbox"/> overwrite</p> <p><input type="checkbox"/> overwrite</p> </div> </div> <div style="display: flex; justify-content: center; margin-top: 10px;"> <span style="margin: 0 10px;">Upload</span> <span>Cancel</span> </div> </div>
	<p><b>Storing the current parameter settings of the WEB-GUI into the device</b></p>
	<p><b>Saving the device configuration to a storage media</b></p> <p>Attention: Modifications in the WEB-GUI, which haven't been stored in the device, will not be written to the storage media.</p>

## 7.6 Alarming

The alarming concept is very flexible. Depending on the user requirements simple or more advanced monitoring tasks may be realized. The most important objects are limit values, monitoring functions and the summary alarm.

### 7.6.1 Limit values

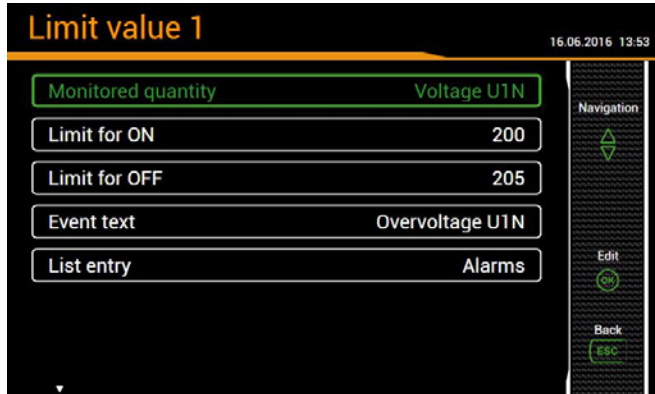

Using limit values either the exceeding of a given value (upper limit) or the fall below a given value (lower limit) is monitored.

Limits values are defined by means of two parameters: Limit for ON / OFF. The hysteresis corresponds to the difference between these two values.

If a data logger is implemented both state transitions OFF→ON and ON→OFF can be recorded as event or alarm in the appropriate lists.

**Upper limit:**  $\text{Limit for ON} \geq \text{Limit for OFF}$

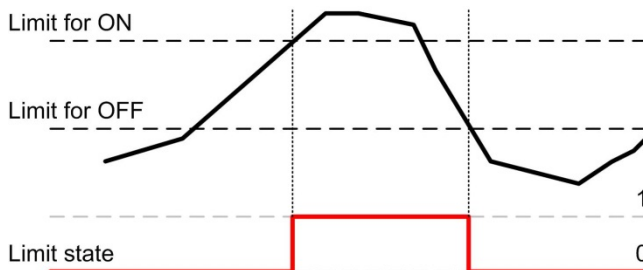

- ▶ The limit value becomes active (1) as soon as the limit for ON state is exceeded. It remains active until the associated measured quantity falls below the limit for OFF state again.
- ▶ The limit value is inactive (0) if either the limit for ON is not yet reached or if, following the activation of the limit value, the associated measured quantity falls below the limit for OFF state again.

**Lower limit:**  $\text{Limit for ON} < \text{Limit for OFF}$

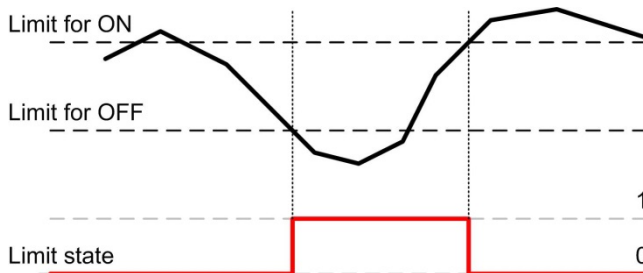

- ▶ The limit value becomes active (1) as soon as the associated measured quantity falls below the limit for ON state. It remains active until the associated measured quantity exceeds the limit for OFF state again.
- ▶ The limit value is inactive (0) if either the associated measured quantity is higher than the limit for ON state or if, following the activation of the limit value, it exceeds the limit for OFF state again.



If the limit for ON state and the limit for OFF state are configured to the same value, the limit value will be treated as an upper limit value without hysteresis.

Limit value states can:

- ... directly be used as source for a digital output
- ... be used as logic input for a monitoring function
- ... be recorded as event or alarm in the appropriate lists on each changing

## 7.6.2 Monitoring functions

By means of monitoring functions the user can define an extended condition monitoring, e.g. for triggering an over-current alarm, if one of the phase currents exceeds a certain limit value.

The states of all monitoring functions

...will be shown in the alarm list ("Events" via main menu)

...build a summary alarm state

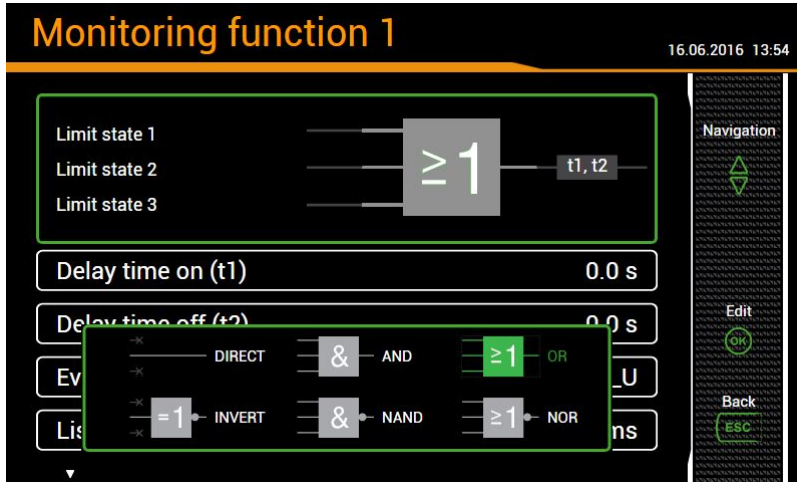

### Logic inputs

Up to three states of limit values, logic inputs or other monitoring functions. Unused inputs will automatically be initialized in a way that they do not influence the output.

### Logic function

For the logical combination of the inputs the function AND, NAND, OR, NOR, DIRECT and INVERT are available. These logical functions are described in [Appendix C](#).

### Delay time on

The time a condition must be present until it is forwarded

### Delay time off

Time to be waited until a condition, which is no longer present, will be released again

### Description

This text will be used for visualization in the alarm list

### List entry (with data logger only)

- *Alarm / event*: Each state transition will be recorded in the appropriate list
- *none*: No recording of state transitions

### Possible follow-up actions

- Driving a logic output. The assignment of the monitoring function to a digital output / relay is done via the settings of the corresponding output.
- Visualization of the present state in the alarm list
- Combining the states of all monitoring functions to create a summary alarm
- Recording of state transitions as alarm or event in the appropriate lists

### 7.6.3 Summary alarm

The summary alarm combines the states of all monitoring function MFx to a superior alarm-state of the overall unit. For each monitoring function you may select if it is used for building the summary alarm state. If at least one of the used functions is in the alarm state, the summary alarm is also in the alarm state.

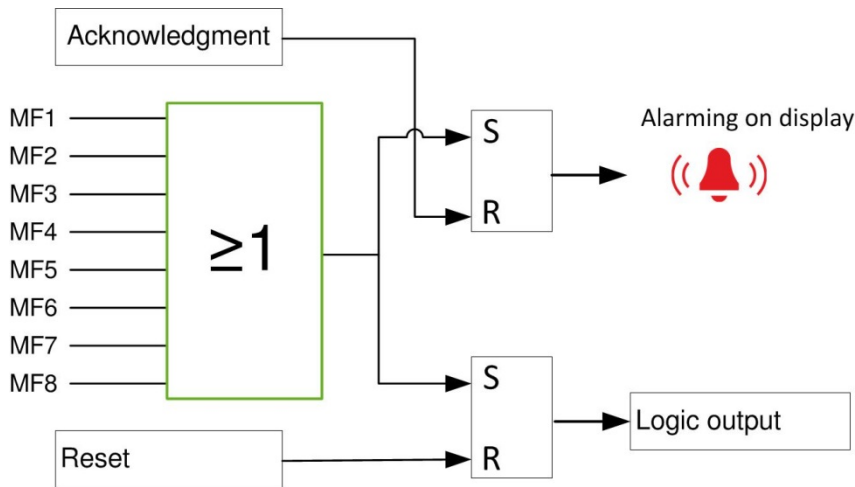

#### Alarm display

The symbol arranged in the status bar signalizes if there are active alarms or not.

**Acknowledgment:** By acknowledging the summary alarm, the user confirms that he has recognized that an alarm state occurred. The acknowledgment is done automatically as soon as the user selects the alarm list to be displayed locally or via web browser or if the alarm state no longer exists. By acknowledging only the flashing of the alarm symbol stops, the symbol itself remains statically displayed until none of the monitoring functions is in the alarm state.

#### Logic output

The summary alarm can drive an output. The assignment of a digital output / relay to the summary alarm is done via the settings of the corresponding output.

**Reset:** The state of the summary alarm - and therefore of the used output - can be reset, even if there is still an alarm active. So, for example a horn activated via summary alarm can be deactivated. A reset may be performed via display, via web browser, a digital input or the Modbus interface. The logic output becomes active again as soon as another monitoring function goes to the alarm state or if the same alarm becomes active again.

#### Alarm state display





The digital or relay output assigned to the summary alarm can be reset by means of the <OK> key. So the active alarming will be stopped. But the alarm state of the summary alarm remains active until the alarm state no longer exists.



## 7.7 Data recording

The optional data logger provides long-term recordings of measurement progressions and events. The recording is performed in endless mode (oldest data will be deleted, as soon as the associated memory is full). Depending on the version ordered, the following data groups are available:

Group	Data type	Request	
Periodical data	<ul style="list-style-type: none"> <li>• Mean-values versus time</li> <li>• Periodical meter readings</li> </ul>	 Energy	<ul style="list-style-type: none"> <li>• Mean value logger</li> <li>• Meter logger</li> </ul>
Events	In Form of a logbook with time information: <ul style="list-style-type: none"> <li>• Event list: Every state transition of monitoring functions or limit values, classified as event</li> <li>• Alarm list: Every state transition of monitoring functions or limit values, classified as alarm</li> <li>• Operator list: The occurrence of system events, such as configuration changes, power failures or reset operations and much more</li> </ul>	 Events	<ul style="list-style-type: none"> <li>• Event and alarm list</li> <li>• Operator list</li> </ul>
Disturbance recorder	Events will be registered in the disturbance recorder list. By selecting the entries: <ul style="list-style-type: none"> <li>• the course of the RMS values of all U/I</li> <li>• the curve shape of all U/I</li> </ul> during the disturbance will be recorded	 Events	<ul style="list-style-type: none"> <li>• Disturbance recorder</li> </ul>

### 7.7.1 Periodical data

#### Configuration of the periodical data recording

The recording of all configured mean-values and meters is started automatically. The recording of the mean-values is done every when the appropriate averaging interval expires. For meters the reading interval can be configured, individually for standard and user-defined meters.

#### Displaying the chronology of the mean values

The chronology of the mean values is available via the menu **Energy** and is divided in two groups:

- Pre-defined power mean values
- User-defined mean values

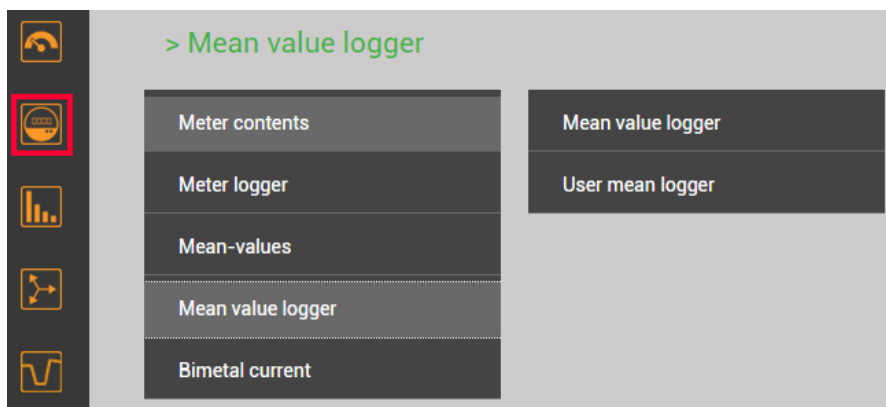

*Selection of the mean values group*



The selection of the mean-value quantity to display can be performed via choosing the corresponding register. Three different kind of displays are supported:

- Daily profile: Hourly mean-values will be shown, independently of the real averaging time
- Weekly profile
- Table: Listing of all acquired mean-values in the sequence of the real averaging interval

The graphical representation allows to compare directly the values of the previous day resp. week.



By selecting the bars you may read the associated values:

- Mean-value
- Min. RMS value within the interval
- Max. RMS value within the interval



Weekly display



Weekly display: Reading

#	time	mean	min(interval)	max(interval)
1	14.06.2016, 14:33:00.000	79.89 kW	65.75 kW	109.42 kW
2	14.06.2016, 14:32:00.000	93.65 kW	74.90 kW	123.97 kW
3	14.06.2016, 14:31:00.000	86.42 kW	74.48 kW	104.69 kW
4	14.06.2016, 14:30:00.000	80.77 kW	67.35 kW	106.59 kW
5	14.06.2016, 14:29:00.000	88.62 kW	75.01 kW	111.77 kW
6	14.06.2016, 14:28:00.000	90.96 kW	69.96 kW	114.12 kW
7	14.06.2016, 14:27:00.000	81.96 kW	68.81 kW	108.47 kW
8	14.06.2016, 14:26:00.000	80.98 kW	69.05 kW	102.54 kW
9	14.06.2016, 14:25:00.000	88.52 kW	68.12 kW	123.43 kW
10	14.06.2016, 14:24:00.000	89.96 kW	70.46 kW	134.78 kW

Mean values in table format

## Displaying the chronology of meter contents

The chronology of meters is available via the menu **Energy** and is divided in two groups:

- Pre-defined meters
- User-defined meters

From the difference of two successive meter readings the energy consumption for the dedicated time range can be determined.

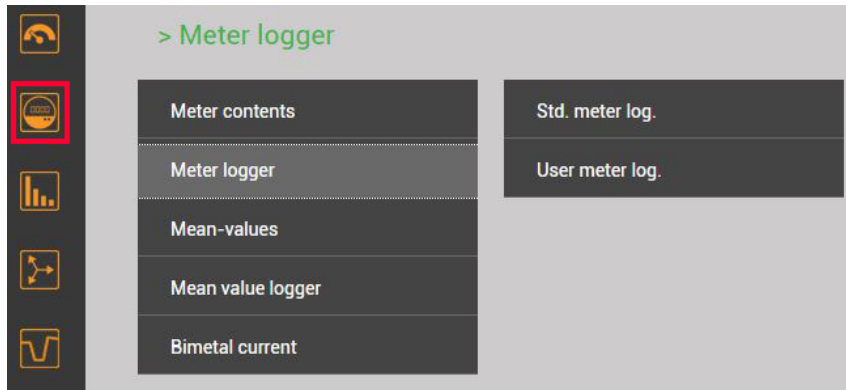

Selection of the meter logger group

> Std. meter log.

Log. ΣP(+IV) | Log. ΣP(+II+III) | Log. ΣQ(+II) | Log. ΣQ(+II+IV)

«Previous 1 2 3 4 5 Next» Results per page 25

#	time	ΣP(+IV), ΣIT	ΣP(+IV), ΣHT
1	15.06.2016, 14:00:00.000	0 kWh	33276.80 kWh
2	15.06.2016, 13:00:00.000	0 kWh	33203.10 kWh
3	15.06.2016, 12:00:00.000	0 kWh	33137.40 kWh
4	15.06.2016, 11:00:00.000	0 kWh	33069.10 kWh
5	15.06.2016, 10:00:00.000	0 kWh	32996 kWh
6	15.06.2016, 09:00:00.000	0 kWh	32919.70 kWh
7	15.06.2016, 08:00:00.000	0 kWh	32849.90 kWh
8	15.06.2016, 07:00:00.000	0 kWh	32784 kWh
9	15.06.2016, 06:00:00.000	0 kWh	32735.30 kWh
10	15.06.2016, 05:00:00.000	0 kWh	32719.10 kWh
11	15.06.2016, 04:00:00.000	0 kWh	32687.10 kWh

Meter content readings in table form

## Displaying data locally

The selection works in principle in the same way as with the WEB-GUI. There are the following differences:

- The individual measured quantities are arranged in a display matrix and can be selected via navigation.
- The number of displayable meter readings is limited to 25
- The time range of the mean values is limited to the present day resp. the present week. There is no possibility for navigation.

## Data export as CSV file

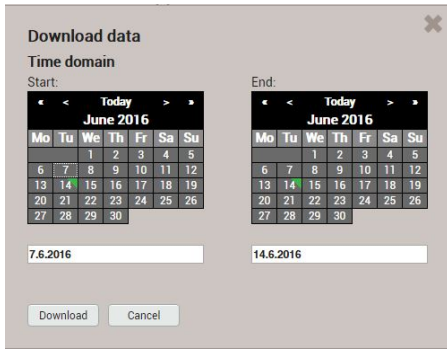

Via  the time range of the data to export can be selected. A CSV (Comma separated value) file will be generated. This can be imported als a text file to Excel, with comma as a separator.

The same file contains data for all quantities of the respective group.

### 7.7.2 Events

#### Configuration of events

For all [monitoring functions](#) and [limit values](#) for which state transitions need to be recorded, the parameter “list entry” must be set to either events or alarms.

#### Displaying of event entries

Event lists are a kind of loogbook. The occurrence of monitored events is recorded in the appropriate list with the time of its occurrence. There are the following lists:

- Alarm list
- Event list
- Operator list

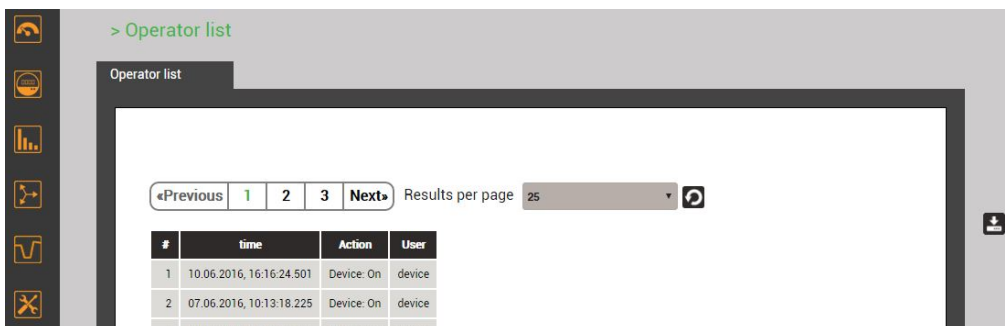
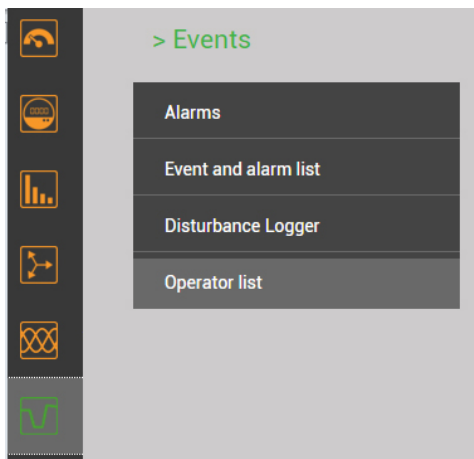

*Example of an operator list*

#### Displaying data locally

The selection works in principle in the same way as with the WEB-GUI. There is the following difference:

- The number of displayable events is limited to 25

### 7.7.3 Disturbance recorder

#### Configuration of the events to record

The device monitors the events voltage dip, swell and interruption. The user can define the threshold levels for these events in the menu **Settings | Disturbance Logger**.

#### Display of disturbance recordings (locally)

Recorded disturbances are available in the form of a logbook. Each detected disturbance is entered into the disturbance recorder list with the time of its occurrence. By selecting a list entry the graphical display of the measured values during this event is entered. The following presentations are available:

- Half cycle RMS curves of all voltages, all currents, all voltages and currents
- Curve shapes of all voltages, all currents, all voltages and currents

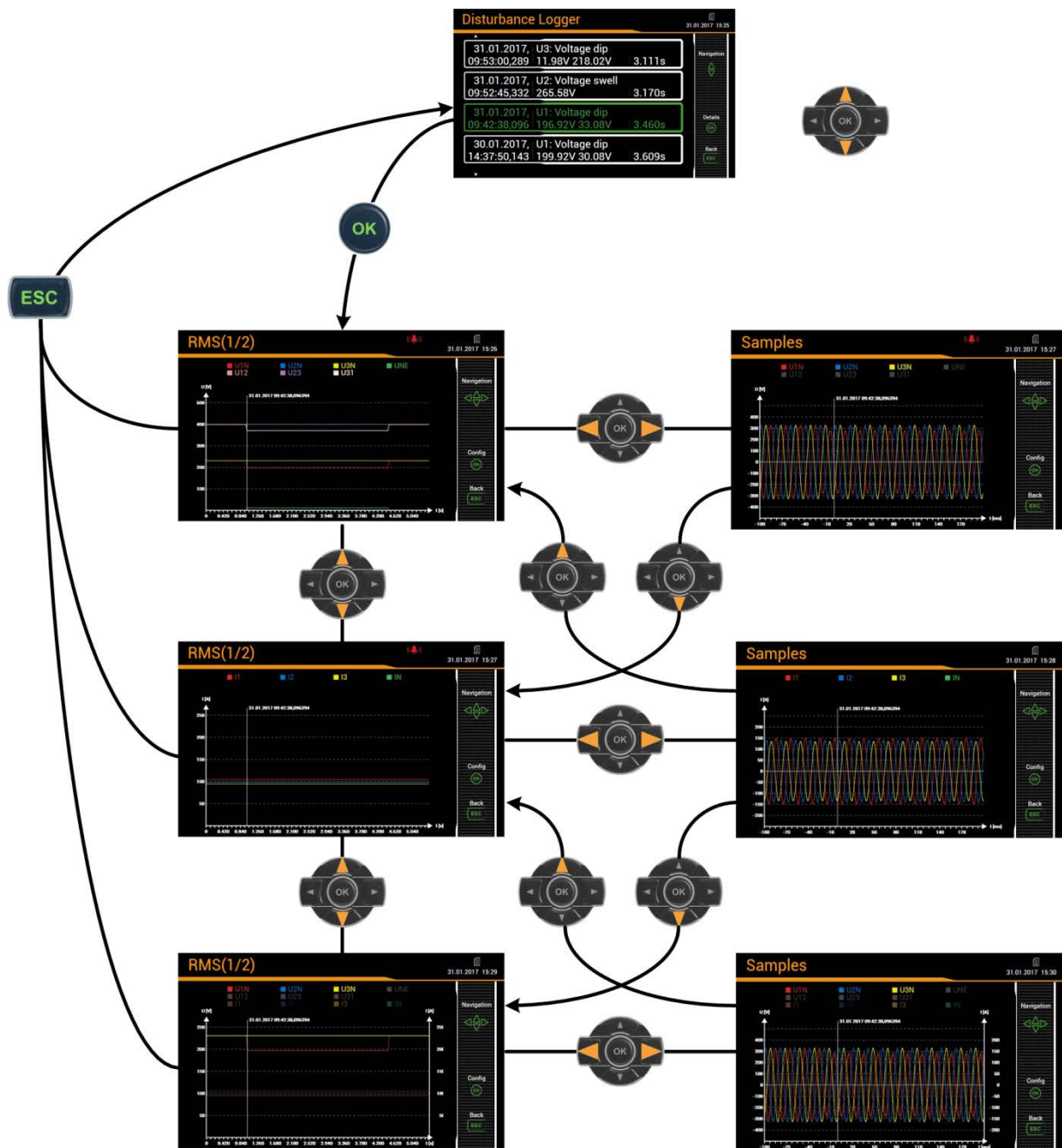

Display matrix on the local display

## Restriction of the quantities to display on the local display

The user can adapt the displayed information to its needs. Once the graphic is displayed, the setting window for the selection of the quantities to display is entered by pressing <OK>.

### Voltage display

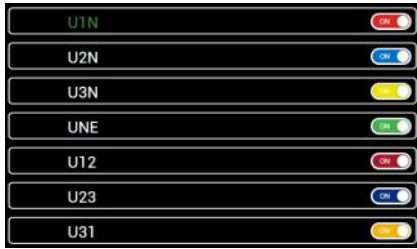

### Current display

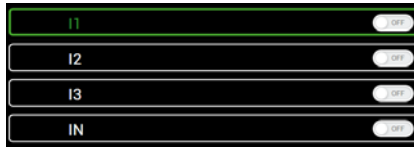

### Mixed display

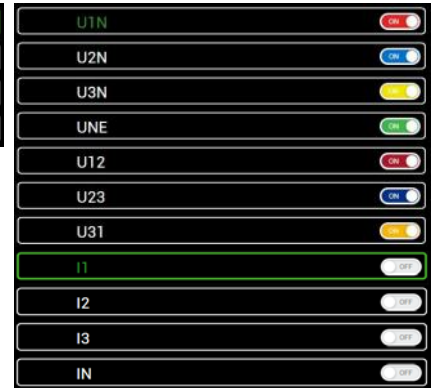

## Display of disturbance recordings (WEB-GUI)

As with the local GUI, recorded disturbances are available in the form of a logbook. By selecting a list entry the graphical display of the measured values during this event is entered.

#	time	Trigger channel	Event type	Event value	Event value	Duration [s]
1	31.01.2017, 09:53:00,289	U3	Voltage dip	Residual voltage: 11.98 V	Depth: 218.02 V	3.111
2	31.01.2017, 09:52:45,332	U2	Voltage swell	Maximum magnitude: 265.58 V		3.170
3	31.01.2017, 09:42:38,096	U1	Voltage dip	Residual voltage: 196.92 V	Depth: 33.08 V	3.460
4	30.01.2017, 14:27:50,143	U1	Voltage dip	Residual voltage: 199.92 V	Depth: 30.08 V	3.609

### List of disturbance recordings

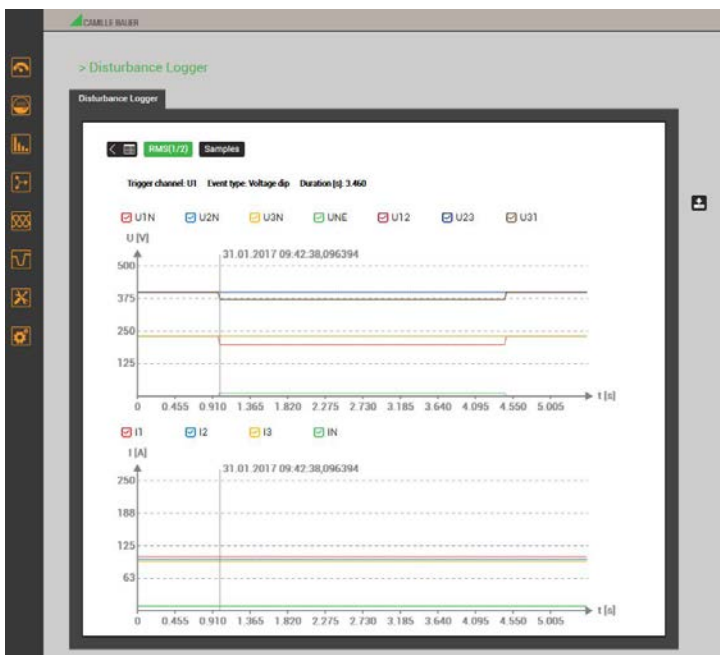

### Graphical display of a disturbance recording

## 7.7.4 Micro SD card

Devices with data logger are supplied with a micro SD-Card, which provides long recording times.

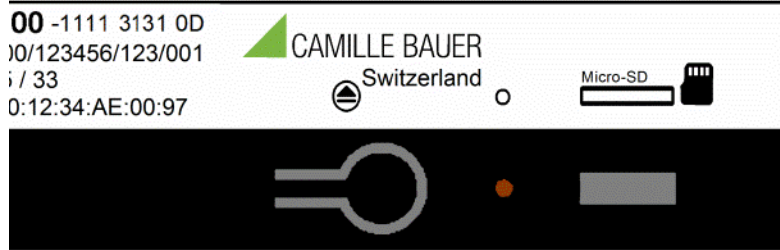

### Activity

The red LED located next to the SD card signals the logger activity. When data is written to the SD card the LED becomes shortly dark.

### Exchanging the card

For exchanging the SD card the removal key needs to be pressed. Once the LED becomes green the card is logged off and can be removed. To remove the card, press it slightly into the device to release the locking mechanism: The card is pushed out of the device.

If the SD card is not removed within 20s the exchanging procedure is cancelled and the card will be mounted to the system again.

Data cannot be temporarily stored in the device. If there is no SD card in the device no recordings can be done.



**Data stored on the SD card can be accessed only as long as the card is in the device. Stored data may be read and analyzed via the webpage of the device or in reduced scope via display.**

**Thus before removing the SD card from the device, all data need to be read via Ethernet interface.**

## 7.8 Timeouts

The device is designed to display measurements. So, any other procedure will be terminated after a certain time without user interaction and the last active measurement image will be shown again.

### Menu timeout

A menu timeout takes effect after 2 min. without changing the present menu selection. It doesn't matter if the currently displayed menu is the main menu or a sub-menu: The menu is closed and the last active measurement image is displayed again.

### Configuration timeout

After 5 min. without interaction in a parameter selection or during entering a value in the settings menu, the active configuration step is closed and the associated parameter remains unchanged. The next step depends on what you have done before:

- If the user did not change configuration parameters before the aborted step, the main menu will be displayed and the device starts to monitor a possible menu timeout.
- If the user changed configuration parameters before the aborted step, the query "Store configuration changes?" is shown. If the user does not answer this query within 2 min. this dialogue is closed: The changed configuration will be stored and activated and then the last active measurement image is displayed again.



## 8. Service, maintenance and disposal

### 8.1 Calibration and new adjustment

Each device is adjusted and checked before delivery. The condition as supplied to the customer is measured and stored in electronic form.

The uncertainty of measurement devices may be altered during normal operation if, for example, the specified ambient conditions are not met. If desired, in our factory a calibration can be performed, including a new adjustment if necessary, to assure the accuracy of the device.

### 8.2 Cleaning

The display and the operating keys should be cleaned in regular intervals. Use a dry or slightly moist cloth for this.



#### **Damage due to detergents**

Detergents may not only affect the clearness of the display but also can damage the device. Therefore, do not use detergents.

### 8.3 Battery

The device contains a battery for buffering the internal clock. It cannot be changed by the user. The replacement can be done at the factory only.

If the UPS option is implemented, the associated battery pack needs to be exchanged regularly. For more information see [chapter 5.11](#).

### 8.4 Disposal

The product must be disposed in compliance with local regulations. This particularly applies to the built-in battery.

## 9. Technical data

### Inputs

<b>Nominal current:</b>	adjustable 1...5 A; max. 7.5 A (sinusoidal)
Measurement category:	CAT III (300V)
Consumption:	$\leq I^2 \times 0.01 \Omega$ per phase
Overload capacity:	10 A continuous 100 A, 5 x 1 s, interval 300 s
<b>Nominal voltage:</b>	57.7...400 V <sub>LN</sub> , 100...693 V <sub>LL</sub> ; max. 480 V <sub>LN</sub> , 832 V <sub>LL</sub> (sinusoidal)
Measurement category:	CAT III (600V)
Consumption:	$\leq U^2 / 1.54 M\Omega$ per phase
Impedance:	1.54 M $\Omega$ per phase
Overload capacity:	480 V <sub>LN</sub> , 832 V <sub>LL</sub> continuous 800 V <sub>LN</sub> , 1386 V <sub>LL</sub> , 10 x 1 s, interval 10s

<b>Systems:</b>	Single phase Split phase (2-phase system) 3-wire, balanced load 3-wire, balanced load, phase shift (2xU,1xI) 3-wire, unbalanced load 3-wire, unbalanced load, Aron connection 4-wire, balanced load 4-wire, unbalanced load 4-wire, unbalanced load, Open-Y
Nominal frequency:	42... <u>50</u> ...58Hz or 50.5... <u>60</u> ...69.5Hz, configurable
Measurement TRMS:	Up to the 60 <sup>th</sup> harmonic

### Measurement uncertainty

*Reference conditions:* Acc. IEC/EN 60688, ambient 15...30°C, sinusoidal input signals (form factor 1.1107), no fixed frequency for sampling, measurement time 200ms (10 cycles at 50Hz, 12 cycles at 60Hz)

Voltage, current:	$\pm 0.1\%$ <sup>1) 2)</sup>
Neutral current:	$\pm 0.2\%$ <sup>1)</sup> (if calculated)
Power:	$\pm 0.2\%$ <sup>1) 2)</sup>
Power factor:	$\pm 0.2^\circ$
Frequency:	$\pm 0.01$ Hz
Imbalance U, I:	$\pm 0.5\%$
Harmonics:	$\pm 0.5\%$
THD U, I:	$\pm 0.5\%$
Active energy:	Class 0.5S, EN 62053-22
Reactive energy:	Class 0.5S, EN 62053-24

*Measurement with fixed system frequency:*

General	$\pm$ Basic uncertainty x (F <sub>config</sub> -F <sub>actual</sub> ) [Hz] x 10
Imbalance U	$\pm 2\%$ up to $\pm 0.5$ Hz
Harmonics	$\pm 2\%$ up to $\pm 0.5$ Hz
THD, TDD	$\pm 3.0\%$ up to $\pm 0.5$ Hz

<sup>1)</sup> Related to the nominal value of the basic quantity

<sup>2)</sup> Additional uncertainty if neutral wire not connected (3-wire connections)

- Voltage, power: 0.1% of measured value; load factor: 0.1°
- Energy: Voltage influence x 2, angle influence x 2

### Zero suppression, range limitations

The measurement of specific quantities is related to a pre-condition which must be fulfilled, that the corresponding value can be determined and sent via interface or displayed. If this condition is not fulfilled, a default value is used for the measurement.

Quantity	Condition	Default
Voltage	$U_x < 1\% U_{x_{nom}}$	0.00
Current	$I_x < 0,1\% I_{x_{nom}}$	0.00
PF	$S_x < 1\% S_{x_{nom}}$	1.00
QF, LF, $\tan\varphi$	$S_x < 1\% S_{x_{nom}}$	0.00
Frequency	voltage and/or current input too low <sup>1)</sup>	Nominal frequency
Voltage unbalance	$U_x < 5\% U_{x_{nom}}$	0.00
Current unbalance	mean value of phase currents $< 5\% I_{x_{nom}}$	0.00
Phase angle U	at least one voltage $U_x < 5\% U_{x_{nom}}$	120°
Harmonics U, THD-U	fundamental $< 5\% U_{x_{nom}}$	0.00

<sup>1)</sup> Specific levels depends on the device configuration

**Power supply** via terminals 13-14  
Measurement category: CAT III (300V)  
Nominal voltage: (see nameplate)  
V1: 110...230V AC 50/60Hz / 130...230V DC  $\pm 15\%$  or  
V2: 24...48V DC  $\pm 15\%$  or  
V3: 110...200V AC 50/60Hz / 110...200V DC  $\pm 15\%$   
Consumption: depends on the device hardware used  
 $\leq 20 \text{ VA}, \leq 12 \text{ W}$

## I/O interface

### Available inputs and outputs

<b>Basic unit</b>	- 1 digital input - 2 digital outputs
<b>I/O extensions</b>	Optional modules: - 2 relay outputs with changeover contacts OR - 2 bipolar analog outputs OR - 4 bipolar analog outputs OR - 4 passive digital inputs OR - 4 active digital inputs

Up to 4 I/O extensions may be present in the device. Only one module can be equipped with analog outputs.

<b>Analog outputs</b>	via plug-in terminals
Linearization:	Linear, kinked
Range:	$\pm 20$ mA (24 mA max.), bipolar
Uncertainty:	$\pm 0.2\%$ of 20 mA
Burden:	$\leq 500 \Omega$ (max. 10 V / 20 mA)
Burden influence:	$\leq 0.2\%$
Residual ripple:	$\leq 0.4\%$
Response time:	220...420 ms

<b>Relays</b>	via plug-in terminals
Contact:	changeover contact
Load capacity:	250 V AC, 2 A, 500 VA 30 V DC, 2 A, 60 W

<b>Passive digital inputs</b>	via plug-in terminals
Nominal voltage	12 / 24 V DC (30 V max.)
Input current	$< 7$ mA
Logical ZERO	- 3 up to + 5 V
Logical ONE	8 up to 30 V
Minimum pulse width	30...250ms

<b>Active digital inputs</b>	via plug-in terminals
Open circuit voltage	$\leq 15$ V
Short circuit current	$< 15$ mA
Current at $R_{ON}=800\Omega$	$\geq 2$ mA
Minimum pulse width	30...250ms

<b>Digital outputs</b>	via plug-in terminals
Nominal voltage	12 / 24 V DC (30 V max.)
Nominal current	50 mA (60 mA max.)
Load capability	400 $\Omega$ ... 1 M $\Omega$

### Interface

<b>Ethernet</b>	via RJ45 connector
Protocol:	Modbus/TCP, NTP, http
Physics:	Ethernet 100BaseTX
Mode:	10/100 Mbit/s, full/half duplex, auto-negotiation

<b>Modbus/RTU</b>	via plug-in terminal (A, B, C/X)
Protocol:	Modbus/RTU
Physics:	RS-485, max. 1200m (4000 ft)
Baud rate:	9'600, 19'200, 38'400, 57'600, 115'200 Baud
Number of participants:	$\leq 32$

### Internal clock (RTC)

Uncertainty:  $\pm 2$  minutes / month (15 up to 30°C)  
Synchronization: via Ethernet (NTP protocol)  
Running reserve: > 10 years

### Uninterruptible power supply (UPS)

Type: VARTA Easy Pack EZPAckL, UL listed MH16707  
Nominal voltage: 3.7V  
Capacity: 1150 mAh min., 4.5 Wh  
Operating duration: 5 times 3 minutes  
Life time: 3 up to 5 years, depending on operating and ambient conditions

### Ambient conditions, general information

Operating temperature: 

- Device without UPS: -10 up to 15 up to 30 up to + 55°C
- Device with UPS: 0 up to 15 up to 30 up to + 35°C

Storage temperature: Base device: -25 up to + 70°C;  
Battery pack UPS: -20...60°C (<1 month); -20°...45°C (< 3 months);  
-20...30°C (< 1 year)

Temperature influence: 0.5 x measurement uncertainty per 10 K  
Long term drift: 0.5 x measurement uncertainty per year  
Others: Usage group II (EN 60 688)  
Relative humidity: < 95% no condensation  
Altitude:  $\leq 2000$  m max.  
Device to be used indoor only!

### Mechanical attributes

Orientation: Any  
Housing material: Polycarbonate (Makrolon)  
Flammability class: V-0 acc. UL94, non-dripping, free of halogen  
Weight: 800 g  
Dimensions: [Dimensional drawings](#)

### Vibration withstand (test according to DIN EN 60 068-2-6)

Acceleration:  $\pm 0.25$  g (operating); 1.20 g (storage)  
Frequency range: 10 ... 150 ... 10 Hz, rate of frequency sweep: 1 octave/minute  
Number of cycles: 10 in each of the 3 axes

## Safety

The current inputs are galvanically isolated from each other

Protection class: II (protective insulation, voltage inputs via protective impedance)

Pollution degree: 2

Protection: IP54 (front), IP30 (housing), IP20 (terminals)

Measurement category: CAT III

Rated voltage Power supply V1: 110...230V AC / 130...230V DC  $\pm 15\%$

(versus earth): Power supply V2: 24...48V DC  $\pm 15\%$ :

Power supply V3: 110...200V AC / 110...200V DC  $\pm 15\%$

Relay: 250 V AC (CAT III)

I/O's: 24 V DC

Test voltages: Test time 60s, acc. IEC/EN 61010-1 (2011)

- power supply versus inputs U <sup>1)</sup>: 3600V AC
- power supply versus inputs I: 3000V AC
- power supply V1, V3 versus bus, I/O's: 3000V AC
- power supply V2 versus bus, I/O's: 880V DC
- inputs U versus inputs I: 1800V AC
- inputs U versus bus, I/O's <sup>1)</sup>: 3600V AC
- inputs I versus bus, I/O's: 3000V AC
- inputs I versus inputs I: 1500V AC

<sup>1)</sup> During type test only, with all protective impedances removed



The device uses the principle of protective impedance for the voltage inputs to ensure protection against electric shock. All circuits of the device are tested during final inspection.

Prior to performing high voltage or isolation tests involving the voltage inputs, all output connections of the device, especially analog outputs, digital and relay outputs as well as Modbus and Ethernet interface, must be removed. A possible high-voltage test between input and output circuits must be limited to 500V DC, otherwise electronic components can be damaged.

## Applied regulations, standards and directives

IEC/EN 61 010-1	Safety regulations for electrical measuring, control and laboratory equipment
IEC/EN 60 688	Electrical measuring transducers for converting AC electrical variables into analog or digital signals
DIN 40 110	AC quantities
IEC/EN 60 068-2-1/ -2/-3/-6/-27:	Ambient tests -1 Cold, -2 Dry heat, -3 Damp heat, -6 Vibration, -27 Shock
IEC/EN 60 529	Protection type by case
IEC/EN 61 000-6-2/ 61 000-6-4:	Electromagnetic compatibility (EMC) Generic standard for industrial environment
IEC/EN 61 131-2	Programmable controllers - equipment, requirements and tests (digital inputs/outputs 12/24V DC)
IEC/EN 61 326	Electrical equipment for measurement, control and laboratory use - EMC requirements
IEC/EN 62 053-31	Pulse output devices for electromechanical and electronic meters (S0 output)
UL94	Tests for flammability of plastic materials for parts in devices and appliances
2011/65/EU (RoHS)	EU directive on the restriction of the use of certain hazardous substances

### Warning

This is a class A product. In a domestic environment this product may cause radio interference in which case the user may be required to take adequate measures.

This device complies with part 15 of the FCC:

Operation is subject to the following two conditions: (1) This device may not cause harmful interference, and (2) this device must accept any interference received, including interference that may cause undesired operation.

This Class A digital apparatus complies with Canadian ICES-0003.

## 10. Dimensional drawings

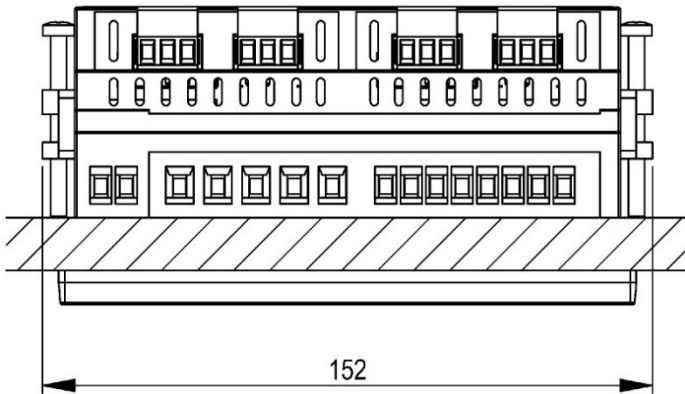
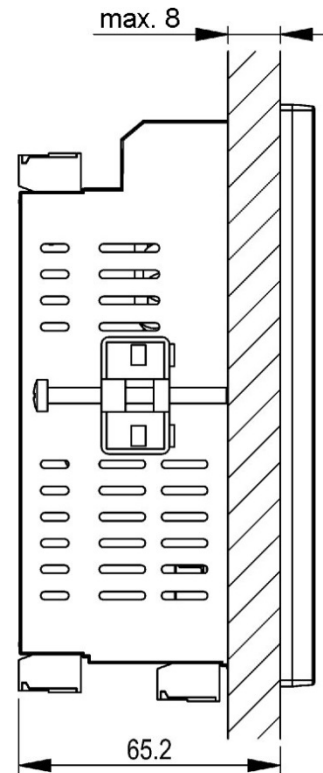
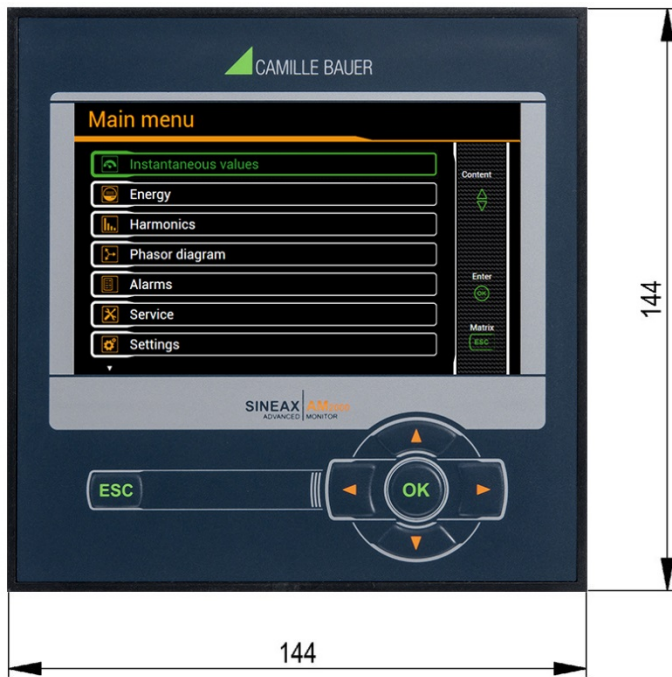

All dimensions in [mm]



# Annex

## A Description of measured quantities

### Used abbreviations

1L	Single phase system
2L	Split phase; system with 2 phases and center tap
3Lb	3-wire system with balanced load
3Lb.P	3-wire system with balanced load, phase shift (only 2 voltages connected)
3Lu	3-wire system with unbalanced load
3Lu.A	3-wire system with unbalanced load, Aron connection (only 2 currents connected)
4Lb	4-wire system with balanced load
4Lu	4-wire system with unbalanced load
4Lu.O	4-wire system with unbalanced load, Open-Y (reduced voltage connection)

### A1 Basic measurements

The basic measured quantities are calculated each 200ms by determining an average over 10 cycles at 50Hz resp. 12 cycles at 60Hz. If a measurement is available depends on the selected system.

Depending on the measured quantity also minimum and maximum values are determined and non-volatile stored with timestamp. These values may be reset by the user via display, see [resetting of measurements](#).

Measurement	present	max	min	1L	2L	3Lb	3Lb.P	3Lu	3Lu.A	4Lb	4Lu.O	4Lu
Voltage U	•	•	•	√	√		√			√		
Voltage U <sub>1N</sub>	•	•	•		√						√	√
Voltage U <sub>2N</sub>	•	•	•		√						√	√
Voltage U <sub>3N</sub>	•	•	•								√	√
Voltage U <sub>12</sub>	•	•	•			√		√	√		√	√
Voltage U <sub>23</sub>	•	•	•			√		√	√		√	√
Voltage U <sub>31</sub>	•	•	•			√		√	√		√	√
Zero displacement voltage U <sub>NE</sub>	•	•		√	√					√	√	√
Current I	•	•		√		√	√			√		
Current I1	•	•			√			√	√		√	√
Current I2	•	•			√			√	√		√	√
Current I3	•	•						√	√		√	√
Neutral current I <sub>N</sub>	•	•		√	√					√	√	√
Earth current I <sub>PE</sub> (calculated)	•	•									√	√
Active power P	•	•		√	√	√	√	√	√	√	√	√
Active power P1	•	•			√						√	√
Active power P2	•	•			√						√	√
Active power P3	•	•									√	√
Fundamental active power P(H1)	•	•		√	√	√	√	√	√	√	√	√
Fundamental active power P1(H1)	•	•			√						√	√
Fundamental active power P2(H1)	•	•			√						√	√
Fundamental active power P3(H1)	•	•									√	√
Total reactive power Q	•	•		√	√	√	√	√	√	√	√	√
Total reactive power Q1	•	•			√						√	√
Total reactive power Q2	•	•			√						√	√
Total reactive power Q3	•	•									√	√
Distortion reactive power D	•	•		√	√	√	√	√	√	√	√	√
Distortion reactive power D1	•	•			√						√	√
Distortion reactive power D2	•	•			√						√	√
Distortion reactive power D3	•	•									√	√
Fundamental reactive power Q(H1)	•	•		√	√	√	√	√	√	√	√	√
Fundamental reactive power Q1(H1)	•	•			√						√	√
Fundamental reactive power Q2(H1)	•	•			√						√	√
Fundamental reactive power Q3(H1)	•	•									√	√

Measurement	present	max	min	1L	2L	3Lb	3Lb.P	3Lu	3Lu.A	4Lb	4Lu.O	4Lu
Apparent power S	•	•		√	√	√	√	√	√	√	√	√
Apparent power S1	•	•			√						√	√
Apparent power S2	•	•			√						√	√
Apparent power S3	•	•									√	√
Fundamental apparent power S(H1)	•	•		√	√	√	√	√	√	√	√	√
Fundamental apparent power S1(H1)	•	•			√						√	√
Fundamental apparent power S2(H1)	•	•			√						√	√
Fundamental apparent power S3(H1)	•	•									√	√
Frequency F	•	•	•	√	√	√	√	√	√	√	√	√
Power factor PF	•			√	√	√	√	√	√	√	√	√
Power factor PF1	•				√						√	√
Power factor PF2	•				√						√	√
Power factor PF3	•										√	√
PF quadrant I			•	√	√	√	√	√	√	√	√	√
PF quadrant II			•	√	√	√	√	√	√	√	√	√
PF quadrant III			•	√	√	√	√	√	√	√	√	√
PF quadrant IV			•	√	√	√	√	√	√	√	√	√
Reactive power factor QF	•			√	√	√	√	√	√	√	√	√
Reactive power factor QF1	•				√						√	√
Reactive power factor QF2	•				√						√	√
Reactive power factor QF3	•										√	√
Load factor LF	•			√	√	√	√	√	√	√	√	√
Load factor LF1	•				√						√	√
Load factor LF2	•				√						√	√
Load factor LF3	•										√	√
cosφ (H1)	•			√	√	√	√	√	√	√	√	√
cosφ L1 (H1)	•				√						√	√
cosφ L2 (H1)	•				√						√	√
cosφ L3 (H1)	•										√	√
cosφ (H1) quadrant I			•	√	√	√	√	√	√	√	√	√
cosφ (H1) quadrant II			•	√	√	√	√	√	√	√	√	√
cosφ (H1) quadrant III			•	√	√	√	√	√	√	√	√	√
cosφ (H1) quadrant IV			•	√	√	√	√	√	√	√	√	√
tanφ (H1)	•			√	√	√	√	√	√	√	√	√
tanφ L1 (H1)	•				√						√	√
tanφ L2 (H1)	•				√						√	√
tanφ L3 (H1)	•										√	√
$U_{mean}=(U1N+U2N)/2$	•				√							
$U_{mean}=(U1N+U2N+U3N)/3$	•											√
$U_{mean}=(U12+U23+U31)/3$	•					√		√	√			
$I_{mean}=(I1+I2)/2$	•				√							
$I_{mean}=(I1+I2+I3)/3$	•							√			√	√
IMS, Average current with sign of P	•			√	√	√	√	√	√	√	√	√
Phase angle between U1 and U2	•					√		√	√		√	√
Phase angle between U2 and U3	•					√		√	√		√	√
Phase angle between U3 and U1	•					√		√	√		√	√
Angle between U and I	•			√		√	√	√	√	√		
Angle between U1 and I1	•				√						√	√
Angle between U2 and I2	•				√						√	√
Angle between U3 and I3	•										√	√
Maximum ΔU <> Um <sup>1)</sup>	•	•			√	√		√	√			√
Maximum ΔI <> Im <sup>2)</sup>	•	•			√			√			√	√

<sup>1)</sup> maximum deviation from the mean value of all voltages (see A3)

<sup>2)</sup> maximum deviation from the mean value of all currents (see A3)

• Available via communication interface only

## Reactive power

Most of the loads consume a combination of ohmic and inductive current from the power system. Reactive power arises by means of the inductive load. But the number of non-linear loads, such as RPM regulated drives, rectifiers, thyristor controlled systems or fluorescent lamps, is increasing. They cause non-sinusoidal AC currents, which may be represented as a sum of harmonics. Thus the reactive power to transmit increases and leads to higher transmission losses and higher energy costs. This part of the reactive power is called distortion reactive power.

Normally reactive power is unwanted, because there is no usable active component in it. Because the transmission of reactive power over long distances is uneconomic, it makes sense to install compensation systems close to the consumers. So transmission capacities may be used better and losses and voltage drops by means of harmonic currents can be avoided.

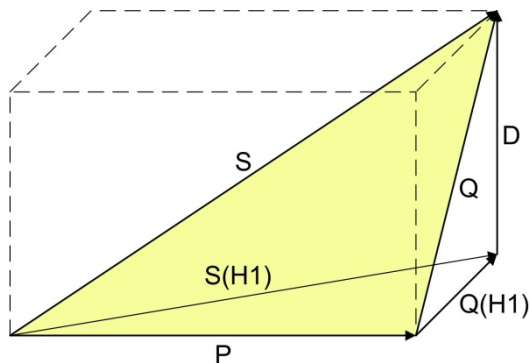

- P: Active power
- S: Apparent power including harmonic components
- S1: Fundamental apparent power
- Q: Total reactive power
- Q(H1): Fundamental reactive power
- D: Distortion reactive power

The reactive power may be divided in a fundamental and a distortion component. Only the fundamental reactive power may be compensated directly by means of the classical capacitive method. The distortion components have to be combated using inductors or active harmonic conditioners.

The **load factor PF** is the relation between active power P and apparent power S, including all possibly existing harmonic parts. This factor is often called  $\cos\varphi$ , which is only partly correct. The PF corresponds to the  $\cos\varphi$  only, if there is no harmonic content present in the system. So the  $\cos\varphi$  represents the relation between the active power P and the fundamental apparent power S(H1).

The **tanφ** is often used as a target quantity for the capacitive reactive power compensation. It corresponds to the relation of the fundamental reactive power Q(H1) and the active power P.

## Power factors

The **power factor PF** gives the relation between active and apparent power. If there are no harmonics present in the system, it corresponds to the  $\cos\varphi$ . The PF has a range of  $-1 \dots 0 \dots +1$ , where the sign gives the direction of energy flow.

The **load factor LF** is a quantity derived from the PF, which allows making a statement about the load type. Only this way it's possible to measure a range like 0.5 capacitive ... 1 ... 0.5 inductive in a non-ambiguous way.

The **reactive power factor QF** gives the relation between reactive and apparent power.

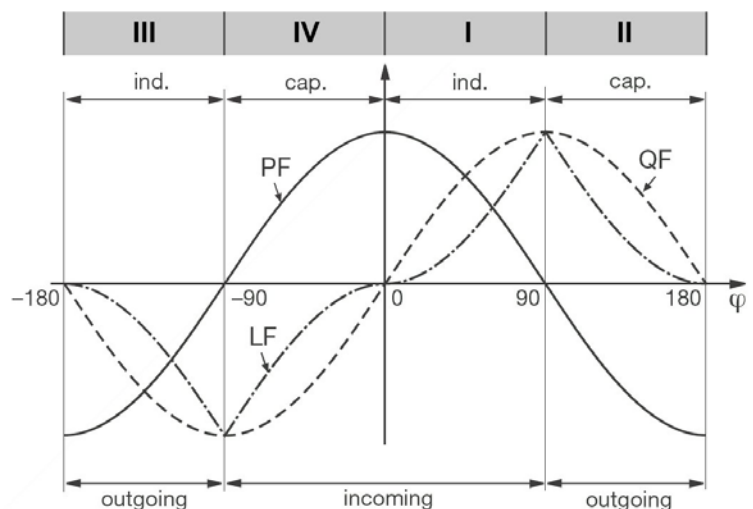

Example from the perspective of an energy consumer

### Zero displacement voltage $U_{NE}$

Starting from the generating system with star point E (which is normally earthed), the star point (N) on load side is shifted in case of unbalanced load. The zero displacement voltage between E and N may be determined by a vectorial addition of the voltage vectors of the three phases:

$$\underline{U}_{NE} = - (\underline{U}_{1N} + \underline{U}_{2N} + \underline{U}_{3N}) / 3$$

A displacement voltage may also occur due to harmonics of order 3, 9, 15, 21 etc., because the dedicated currents add in the neutral wire.

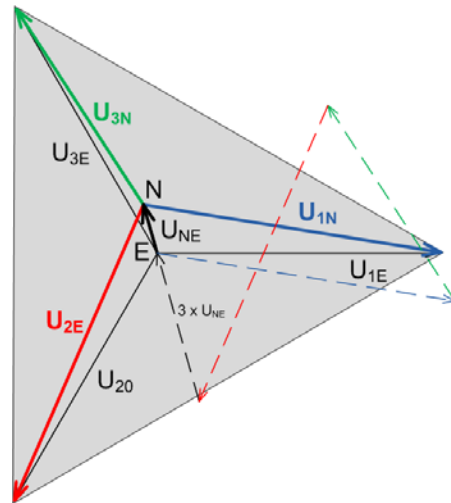

### Earth fault monitoring in IT systems

Via the determination of the zero displacement voltage it's possible to detect a first earth fault in an unearthed IT system. To do so, the device is configured for measurement in a 4-wire system with unbalanced load and the neutral connector is connected to earth. In case of a single phase earth fault there is a resulting zero displacement voltage of  $U_{LL} / \sqrt{3}$ . The alarming may be done e.g. by means of a relay output.

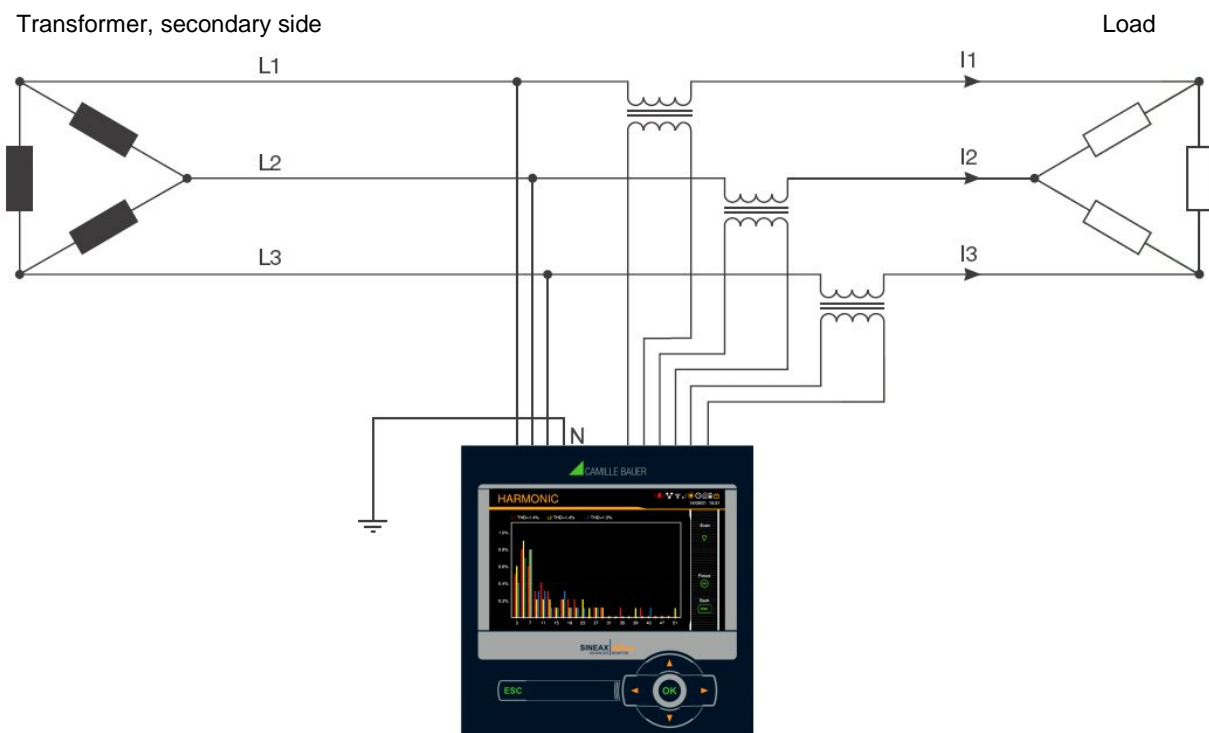

Because in case of a fault the voltage triangle formed by the three phases does not change, the voltage and current measurements as well as the system power values will still be measured and displayed correctly. Also the meters carry on to work as expected.

The method is suited to detect a fault condition during normal operation. A declination of the isolation resistance may not be detected this way. This should be measured during a periodical control of the system using a mobile system.

Another possibility to analyze fault conditions in a grid offers the method of the [symmetrical components](#) as described in A3.

## A2 Harmonic analysis

The harmonic analysis is performed according IEC 61000-4-7 over 10 cycles at 50Hz resp. 12 cycles at 60Hz. If a measured quantity is available depends on the selected system.

Measurement	prese	max	1L	2L	3Lb	3Lb.P	3Lu	3Lu.A	4Lb	4Lu.O	4Lu
THD Voltage U1N/U	•	•	√	√		√			√	√	√
THD Voltage U2N	•	•		√						√	√
THD Voltage U3N	•	•								√	√
THD Voltage U12	•	•			√		√	√			
THD Voltage U23	•	•			√		√	√			
THD Voltage U31	•	•			√		√	√			
THD Current I1/I	•	•	√	√	√	√	√	√	√	√	√
THD Current I2	•	•		√			√	√		√	√
THD Current I3	•	•					√	√		√	√
TDD Current I1/I	•	•	√	√	√	√	√	√	√	√	√
TDD Current I2	•	•		√			√	√		√	√
TDD Current I3	•	•					√	√		√	√
Harmonic contents 2 <sup>nd</sup> ...50 <sup>th</sup> U1N/U	•	•	√	√		√			√	√	√
Harmonic contents 2 <sup>nd</sup> ...50 <sup>th</sup> U2N	•	•		√						√	√
Harmonic contents 2 <sup>nd</sup> ...50 <sup>th</sup> U3N	•	•								√	√
Harmonic contents 2 <sup>nd</sup> ...50 <sup>th</sup> U12	•	•			√		√	√			
Harmonic contents 2 <sup>nd</sup> ...50 <sup>th</sup> U23	•	•			√		√	√			
Harmonic contents 2 <sup>nd</sup> ...50 <sup>th</sup> U31	•	•			√		√	√			
Harmonic contents 2 <sup>nd</sup> ...50 <sup>th</sup> I1/I	•	•	√	√	√	√	√	√	√	√	√
Harmonic contents 2 <sup>nd</sup> ...50 <sup>th</sup> I2	•	•		√			√	√		√	√
Harmonic contents 2 <sup>nd</sup> ...50 <sup>th</sup> I3	•	•					√	√		√	√

Harmonic contents are available up to the 89<sup>th</sup> (50Hz) or 75<sup>th</sup> (60Hz) on the Modbus interface

• Available via communication interface only

### Harmonics

Harmonics are multiples of the fundamental resp. system frequency. They arise if non-linear loads, such as RPM regulated drives, rectifiers, thyristor controlled systems or fluorescent lamps are present in the power system. Thus undesired side effects occur, such as additional thermal stress to operational resources or electrical mains, which lead to an advanced aging or even damage. Also the reliability of sensitive loads can be affected and unexplainable disturbances may occur. In industrial networks the image of the harmonics gives good information about the kind of loads connected. See also:

► [Increase of reactive power due to harmonic currents](#)

### TDD (Total Demand Distortion)

The complete harmonic content of the currents is calculated additionally as Total Demand Distortion, briefly TDD. This value is scaled to the rated current resp. rated power. Only this way it's possible to estimate the influence of the current harmonics on the connected equipment correctly.

### Maximum values

The maximum values of the harmonic analysis arise from the monitoring of THD and TDD. The maximum values of individual harmonics are not monitored separately, but are stored if a maximum value of THD or TDD is detected. The image of the maximum harmonics therefore always corresponds to the dedicated THD resp. TDD.



The accuracy of the harmonic analysis strongly depends on the quality of the current and voltage transformers possibly used. In the harmonics range transformers normally change both, the amplitude and the phase of the signals to measure. It's valid: The higher the frequency of the harmonic, the higher its damping resp. phase shift.

### A3 System imbalance

Measured quantity	prese	max	min	1L	2L	3Lb	3Lb.P	3Lu	3Lu.A	4Lb	4Lu.O	4Lu
UR1: Positive sequence [V]	•					√		√	√			√
UR2: Negative sequence [V]	•					√		√	√			√
U0: Zero sequence [V]	•											√
U: Imbalance UR2/UR1	•	•				√		√	√			√
U: Imbalance U0/UR1	•	•										√
IR1: Positive sequence [A]	•							√			√	√
IR2: Negative sequence [A]	•							√			√	√
I0: Zero sequence [A]	•										√	√
I: Imbalance IR2/IR1	•	•						√			√	√
I: Imbalance I0/IR1	•	•									√	√

• Available via communication interface only

Imbalance in three-phase systems may occur due to single-phase loads, but also due to failures, such as e.g. the blowing of a fuse, an earth fault, a phase failure or an isolation defect. Also harmonics of the 3rd, 9th, 15th, 21st etc. order, which add in the neutral wire, may lead to imbalance. Operating resources dimensioned to rated values, such as three-phase generators, transformers or motors on load side, may be excessively stressed by imbalance. So a shorter life cycle, a damage or failure due to thermal stress can result. Therefore monitoring imbalance helps to reduce the costs for maintenance and extends the undisturbed operating time of the used resources.

Imbalance or unbalanced load relays use different measurement principles. One of them is the approach of the symmetrical components, the other one calculates the maximum deviation from the mean-value of the three phase values. The results of these methods are not equal and don't have the same intention. Both of these principles are implemented in the device.

#### Symmetrical components (acc. Fortescue)

The imbalance calculation method by means of the symmetrical components is ambitious and intensive to calculate. The results may be used for disturbance analysis and for protection purposes in three-phase systems. The real existing system is divided in symmetrical system parts: A positive sequence, a negative sequence and (for systems with neutral conductor) a zero sequence system. The approach is easiest to understand for rotating machines. The positive sequence represents a positive rotating field, the negative sequence a negative (braking) rotating field with opposite sense of direction. Therefore the negative sequence prevents that the machine can generate the full turning moment. For e.g. generators the maximum permissible current imbalance is typically limited to a value of 8...12%.

#### Maximum deviation from the mean value

The calculation of the maximum deviation from the mean value of the phase currents resp. phase voltages gives the information if a grid or substation is imbalanced loaded. The results are independent of rated values and the present load situation. So a more symmetrical system can be aspired, e.g. by changing loads from one phase to another.

Also failure detection is possible. The capacitors used in compensation systems are wear parts, which fail quite often and then have to be replaced. When using three phase power capacitors all phases will be compensated equally which leads to almost identical currents flowing through the capacitors, if the system load is comparable. By monitoring the current imbalance it's then possible to estimate if a capacitor failure is present.

The maximum deviations are calculated in the same steps as the instantaneous values and therefore are arranged there ([see A1](#)).

## A4 Mean values and trend

Measured quantity		Present	Trend	max	min	History
Active power I+IV	1s...60min. <sup>1)</sup>	•	•	•	•	5
Active power II+III	1s...60min. <sup>1)</sup>	•	•	•	•	5
Reactive power I+II	1s...60min. <sup>1)</sup>	•	•	•	•	5
Reactive power III+IV	1s...60min. <sup>1)</sup>	•	•	•	•	5
Apparent power	1s...60min. <sup>1)</sup>	•	•	•	•	5
Mean value quantity 1	1s...60min. <sup>2)</sup>	•	•	•	•	1
....						
Mean value quantity 12	1s...60min. <sup>2)</sup>	•	•	•	•	1

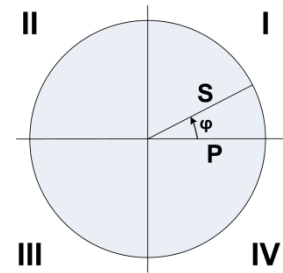

<sup>1)</sup> Interval time t1 <sup>2)</sup> Interval time t2

The device calculates automatically the mean values of all system power quantities. In addition up to 12 further mean value quantities can be freely selected.

### Calculating the mean-values

The mean value calculation is performed via integration of the measured instantaneous values over a configurable averaging interval. The interval time may be selected in the range from one second up to one hour. Possible interim values are set the way that a multiple of it is equal to a minute or an hour. Mean values of power quantities (interval time t1) and free quantities (interval time t2) may have different averaging intervals.

### Synchronization

For the synchronization of the averaging intervals the internal clock or an external signal via digital input may be used. In case of an external synchronization the interval should be within the given range of one second up to one hour. The synchronization is important for making e.g. the mean value of power quantities on generating and demand side comparable.

### Trend

The estimated final value (trend) of mean values is determined by weighted addition of measurements of the past and the present interval. It serves for early detection of a possible exceeding of a given maximum value. This can then be avoided, e.g. by switching off an active load.

### History

For mean values of system powers the last 5 interval values may be displayed on the device or read via interface. For configurable quantities the value of the last interval is provided via communication interface.

### Bimetal current

This measured quantity serves for measuring the long-term effect of the current, e.g. for monitoring the warming of a current-carrying line. To do so, an exponential function is used, similar to the charging curve of a capacitor. The response time of the bimetal function can be freely selected, but normally it corresponds to the interval for determining the power mean-values.

Measured quantity	Present	max	min	1L	2L	3Lb	3Lb.P	3Lu	3Lu.A	4Lb	4Lu.O	4Lu
Bimetal current IB, 1...60min. <sup>3)</sup>	•	•		√		√	√			√		
Bimetal current IB1, 1...60min. <sup>3)</sup>	•	•			√			√	√		√	√
Bimetal current IB2, 1...60min. <sup>3)</sup>	•	•			√			√	√		√	√
Bimetal current IB3, 1...60min. <sup>3)</sup>	•	•						√	√		√	√

<sup>3)</sup> Interval time t3

## A5 Meters

Measured quantity		1L	2L	3Lb	3Lb.P	3Lu	3Lu.A	4Lb	4Lu.O	4Lu
Active energy I+IV, high tariff		•	•	•	•	•	•	•	•	•
Active energy II+III, high tariff		•	•	•	•	•	•	•	•	•
Reactive energy I+II, high tariff		•	•	•	•	•	•	•	•	•
Reactive energy III+IV, high tariff		•	•	•	•	•	•	•	•	•
Active energy I+IV, low tariff		•	•	•	•	•	•	•	•	•
Active energy II+III, low tariff		•	•	•	•	•	•	•	•	•
Reactive energy I+II, low tariff		•	•	•	•	•	•	•	•	•
Reactive energy III+IV, low tariff		•	•	•	•	•	•	•	•	•
User configured meter 1	Only basic quantities can be selected which are supported in the present system.									
User configured meter 2										
User configured meter 3										
User configured meter 4										
User configured meter 5										
User configured meter 6										
User configured meter 7										
User configured meter 8										
User configured meter 9										
User configured meter 10										
User configured meter 11										
User configured meter 12										

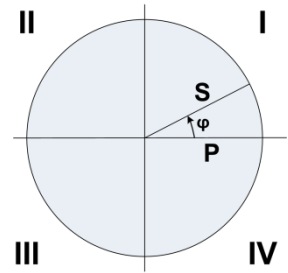

### Standard meters

The meters for active and reactive energy of the system are always active.

### User configured meters

To each of these meters the user can freely assign a basic quantity.

#### Programmable meter resolution



For all meters the resolution (displayed unit) can be selected almost freely. This way, applications with short measurement times, e.g. energy consumption of a working day or shift, can be realized. The smaller the basic unit is selected, the faster the meter overflow is reached.



## B Display matrices

### B0 Used abbreviations for the measurements

#### Instantaneous values















Name	Measurement identification	Unit	Description
U	U TRMS	V	Voltage system
U1N	U 1N TRMS	V	Voltage between phase L1 and neutral
U2N	U 2N TRMS	V	Voltage between phase L2 and neutral
U3N	U 3N TRMS	V	Voltage between phase L3 and neutral
U12	U 12 TRMS	V	Voltage between phases L1 and L2
U23	U 23 TRMS	V	Voltage between phases L2 and L3
U31	U 31 TRMS	V	Voltage between phases L3 and L1
UNE	U NE TRMS	V	Zero displacement voltage 4-wire systems
I	I TRMS	A	Current system
I1	I 1 TRMS	A	Current phase L1
I2	I 2 TRMS	A	Current phase L2
I3	I 3 TRMS	A	Current phase L3
IN	I N TRMS	A	Neutral current
IPE	I PE TRMS		Earth current
P	P TRMS	W	Active power system (P=P1+P2+P3)
P1	P 1 TRMS	W	Active power phase L1
P2	P 2 TRMS	W	Active power phase L2
P3	P 3 TRMS	W	Active power phase L3
Q	Q TRMS	var	Reactive power system (Q=Q1+Q2+Q3)
Q1	Q 1 TRMS	var	Reactive power phase L1
Q2	Q 2 TRMS	var	Reactive power phase L2
Q3	Q 3 TRMS	var	Reactive power phase L3
S	S TRMS	VA	Apparent power system
S1	S 1 TRMS	VA	Apparent power phase L1
S2	S 2 TRMS	VA	Apparent power phase L2
S3	S 3 TRMS	VA	Apparent power phase L3
F	F TRMS	Hz	System frequency
PF	PF TRMS		Active power factor P/S
PF1	PF 1 TRMS		Active power factor P1/S1
PF2	PF 2 TRMS		Active power factor P2/S2
PF3	PF 3 TRMS		Active power factor P3/S3
QF	QF TRMS		Reactive power factor Q / S
QF1	QF 1 TRMS		Reactive power factor Q1 / S1
QF2	QF 2 TRMS		Reactive power factor Q2 / S2
QF3	QF 3 TRMS		Reactive power factor Q3 / S3
LF	LF TRMS		Load factor system
LF1	LF 1 TRMS		Load factor phase L1
LF2	LF 2 TRMS		Load factor phase L2
LF3	LF 3 TRMS		Load factor phase L3
UR1	U pos SEQ	V	Positive sequence voltage
UR2	U neg SEQ	V	Negative sequence voltage
U0	U zero SEQ	V	Zero sequence voltage
IR1	I pos SEQ	A	Positive sequence current
IR2	I neg SEQ	A	Negative sequence current
I0	I zero SEQ	A	Zero sequence current
UR2R1	U neg/pos UNB	%	Unbalance factor voltage UR2/UR1
IR2R1	I neg/pos UNB	%	Unbalance factor current IR2/IR1
U0R1	U zero/pos UNB	%	Unbalance factor voltage U0/UR1
I0R1	I zero/pos UNB	%	Unbalance factor current I0/IR1
IMS	I  TRMS	A	Average current with sign of P

## Minimum and maximum of instantaneous values



















Name	Measurement identification	Unit	Description
U_MM	U TRMS ▲ TS ▼ TS	V	Minimum and maximum value of U
U1N_MM	U 1N TRMS ▲ TS ▼ TS	V	Minimum and maximum value of U1N
U2N_MM	U 2N TRMS ▲ TS ▼ TS	V	Minimum and maximum value of U2N
U3N_MM	U 3N TRMS ▲ TS ▼ TS	V	Minimum and maximum value of U3N
U12_MM	U 12 TRMS ▲ TS ▼ TS	V	Minimum and maximum value of U12
U23_MM	U 23 TRMS ▲ TS ▼ TS	V	Minimum and maximum value of U23
U31_MM	U 31 TRMS ▲ TS ▼ TS	V	Minimum and maximum value of U31
UNE_MAX	U NE TRMS ▲ TS ▼ TS	V	Maximum value of UNE
I_MAX	I TRMS ▲ TS	A	Maximum value of I
I1_MAX	I 1 TRMS ▲ TS	A	Maximum value of I1
I2_MAX	I 2 TRMS ▲ TS	A	Maximum value of I2
I3_MAX	I 3 TRMS ▲ TS	A	Maximum value of I3
IN_MAX	I N TRMS ▲ TS	A	Maximum value of IN
IPE_MAX	I PE TRMS ▲ TS	A	Maximum value of IPE
P_MAX	P TRMS ▲ TS	W	Maximum value of P
P1_MAX	P 1 TRMS ▲ TS	W	Maximum value of P1
P2_MAX	P 2 TRMS ▲ TS	W	Maximum value of P2
P3_MAX	P 3 TRMS ▲ TS	W	Maximum value of P3
Q_MAX	Q TRMS ▲ TS	var	Maximum value of Q
Q1_MAX	Q 1 TRMS ▲ TS	var	Maximum value of Q1
Q2_MAX	Q 2 TRMS ▲ TS	var	Maximum value of Q2
Q3_MAX	Q 3 TRMS ▲ TS	var	Maximum value of Q3
S_MAX	S TRMS ▲ TS	VA	Maximum value of S
S1_MAX	S 1 TRMS ▲ TS	VA	Maximum value of S1
S2_MAX	S 2 TRMS ▲ TS	VA	Maximum value of S2
S3_MAX	S 3 TRMS ▲ TS	VA	Maximum value of S3
F_MM	F TRMS ▲ TS	Hz	Minimum and maximum value of F
UR21_MAX	U neg/pos UNB ▲ TS	%	Maximum value of UR2/UR1
IR21_MAX	I neg/pos UNB ▲ TS	%	Maximum value of IR2/IR1
THD_U_MAX	U THD ▲ TS	%	Max. Total Harmonic Distortion of U
THD_U1N_MAX	U 1N THD ▲ TS	%	Max. Total Harmonic Distortion of U1N
THD_U2N_MAX	U 2N THD ▲ TS	%	Max. Total Harmonic Distortion of U2N
THD_U3N_MAX	U 3N THD ▲ TS	%	Max. Total Harmonic Distortion of U3N
THD_U12_MAX	U 12 THD ▲ TS	%	Max. Total Harmonic Distortion of U12
THD_U23_MAX	U 23 THD ▲ TS	%	Max. Total Harmonic Distortion of U23
THD_U31_MAX	U 31 THD ▲ TS	%	Max. Total Harmonic Distortion of U31
TDD_I_MAX	I TDD ▲ TS	%	Max. Total Demand Distortion of I
TDD_I1_MAX	I 1 TDD ▲ TS	%	Max. Total Demand Distortion of I1
TDD_I2_MAX	I 2 TDD ▲ TS	%	Max. Total Demand Distortion of I2
TDD_I3_MAX	I 3 TDD ▲ TS	%	Max. Total Demand Distortion of I3

TS: Timestamp of occurrence, e.g. 2014/09/17 11:12:03









## Mean-values, trend and bimetal current

Name	Measurement identification	Unit	Description
M1	(m) (p) (q)  (t2)	(mu)	Mean-value 1
M2	(m) (p) (q)  (t2)	(mu)	Mean-value 2
...	(m) (p) (q)  (t2)	(mu)	...
M11	(m) (p) (q)  (t2)	(mu)	Mean-value 11
M12	(m) (p) (q)  (t2)	(mu)	Mean-value 12
TR_M1	(m) (p) (q)  (t2)	(mu)	Trend mean-value 1
TR_M2	(m) (p) (q)  (t2)	(mu)	Trend mean-value 2
...	(m) (p) (q)  (t2)	(mu)	...
TR_M11	(m) (p) (q)  (t2)	(mu)	Trend mean-value 11
TR_M12	(m) (p) (q)  (t2)	(mu)	Trend mean-value 12
IB	IB  (t3)	A	Bimetal current, system
IB1	IB 1  (t3)	A	Bimetal current, phase L1
IB2	IB 2  (t3)	A	Bimetal current, phase L2
IB3	IB 3  (t3)	A	Bimetal current, phase L3

## Minimum and maximum of mean-values and bimetal-current

Name	Measurement identification	Unit	Description
M1_MM	(m) (p) (q)  (t2) 	..	Min/Max mean-value 1
M2_MM	(m) (p) (q)  (t2) 	..	Min/Max mean-value 2
....	(m) (p) (q)  (t2) 	..	....
M11_MM	(m) (p) (q)  (t2) 	..	Min/Max mean-value 11
M12_MM	(m) (p) (q)  (t2) 	..	Min/Max mean-value 12
IB_MAX	IB  (t3) 	A	Maximum bimetal current, system
IB1_MAX	IB 1  (t3) 	A	Maximum Bimetal current, phase L1
IB2_MAX	IB 2  (t3) 	A	Maximum Bimetal current, phase L2
IB3_MAX	IB 3  (t3) 	A	Maximum Bimetal current, phase L3

## Meters

Name	Measurement identification	Unit	Description
$\Sigma P_{I+IV\_HT}$	P  $\Sigma HT$	Wh	Meter P I+IV, high tariff
$\Sigma P_{II+III\_HT}$	P  $\Sigma HT$	Wh	Meter P II+III, high tariff
$\Sigma Q_{I+II\_HT}$	Q  $\Sigma HT$	varh	Meter Q I+II, high tariff
$\Sigma Q_{III+IV\_HT}$	Q  $\Sigma HT$	varh	Meter Q III+IV, high tariff
$\Sigma P_{I+IV\_LT}$	P  $\Sigma LT$	Wh	Meter P I+IV, low tariff
$\Sigma P_{II+III\_LT}$	P  $\Sigma LT$	Wh	Meter P II+III, low tariff
$\Sigma Q_{I+II\_LT}$	Q  $\Sigma LT$	varh	Meter Q I+II, low tariff
$\Sigma Q_{III+IV\_LT}$	Q  $\Sigma LT$	varh	Meter Q III+IV, low tariff
$\Sigma METER1$	(m) (p) (qg) $\Sigma(T)$	(mu)	User meter 1, tariff HT or LT
$\Sigma METER2$	(m) (p) (qg) $\Sigma(T)$	(mu)	User meter 2, tariff HT or LT
.....	(m) (p) (qg) $\Sigma(T)$	(mu)	.....
$\Sigma METER11$	(m) (p) (qg) $\Sigma(T)$	(mu)	User meter 11, tariff HT or LT
$\Sigma METER12$	(m) (p) (qg) $\Sigma(T)$	(mu)	User meter 12, tariff HT or LT

(m): Short description of basic quantity, e.g. „P“

(p): Phase reference of the selected quantity, e.g. „1“

(q): Quadrant information, e.g. „I+IV“

(qg): Graphical quadrant information, e.g. 





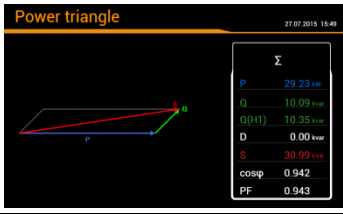
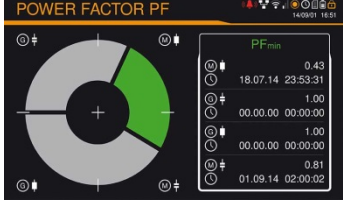
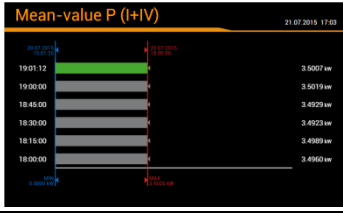
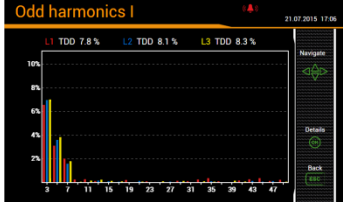
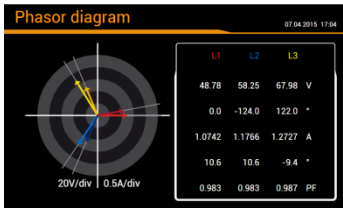

(T): Associated tariff, e.g. „HT“ or „LT“

(mu): Unit of basic quantity







## Graphical measurement displays

Name	Presentation	Description
Px_TRIANGLE		Graphic of the power triangle consisting of: <ul style="list-style-type: none"> <li>Active, reactive and apparent power Px, Qx, Sx</li> <li>Distortion reactive power Dx</li> <li>Fundamental reactive power Qx(H1)</li> <li>cos(φ) of fundamental</li> <li>Active power factor PFx</li> </ul>
PF_MIN		Graphic: Minimum active power factor PF in all 4 quadrants
Cφ_MIN	(as PF_MIN)	Graphic: Minimum cos(φ) in all 4 quadrants
MT_P_I_IV		Graphic mean-value P (I+IV) Trend, last 5 interval values, minimum and maximum
MT_P_II_III	(as MT_P_I_IV)	Graphic mean-value P (II+III) Trend, last 5 interval values, minimum and maximum
MT_Q_I_II	(as MT_P_I_IV)	Graphic mean-value Q (I+II) Trend, last 5 interval values, minimum and maximum
MT_Q_III_IV	(as MT_P_I_IV)	Graphic mean-value Q (III+IV) Trend, last 5 interval values, minimum and maximum
MT_S	(as MT_P_I_IV)	Graphic mean-value S: Trend, last 5 interval values, minimum and maximum
HO_IX		Graphic: Odd harmonics 3 <sup>rd</sup> up to 49 <sup>th</sup> + Total Harmonic Distortion of all currents
HO_UX	(as HO_IX)	Graphic: Odd harmonics 3 <sup>rd</sup> up to 49 <sup>th</sup> + Total Harmonic Distortion of all voltages
HE_IX	(as HO_IX)	Graphic: Even harmonics 2 <sup>nd</sup> up to 50 <sup>th</sup> + Total Harmonic Distortion of all currents
HE_UX	(as HO_IX)	Graphic: Even harmonics 2 <sup>nd</sup> up to 50 <sup>th</sup> + Total Harmonic Distortion of all voltages
HO_UX_MAX	(as HO_IX)	Graphic: Maximum values odd harmonics 3 <sup>rd</sup> up to 49 <sup>th</sup> + Total Harmonic Distortion of all voltages
HO_IX_MAX	(as HO_IX)	Graphic: Maximum values odd harmonics 3 <sup>rd</sup> up to 49 <sup>th</sup> + Total Harmonic Distortion of all currents
HE_UX_MAX	(as HO_IX)	Graphic: Maximum values even harmonics 2 <sup>nd</sup> up to 50 <sup>th</sup> + Total Harmonic Distortion of all voltages
HE_IX_MAX	(as HO_IX)	Graphic: Maximum values even harmonics 2 <sup>nd</sup> up to 50 <sup>th</sup> + Total Harmonic Distortion of all currents
PHASOR		Graphic: All current and voltage phasors with present load situation







## B1 Display matrices for single phase system

Display menu	Corresponding matrix																								
 Instantaneous values	<table border="1"> <tr> <td>U UNE F</td> <td>U_MM UNE_MAX F_MM</td> </tr> <tr> <td>I IN IMS</td> <td>I_MAX IN_MAX</td> </tr> <tr> <td>P Q S PF</td> <td>P_MAX Q_MAX S_MAX</td> </tr> <tr> <td>P_TRIANGLE</td> <td></td> </tr> <tr> <td>PF_MIN</td> <td>Cφ_MIN</td> </tr> </table>	U UNE F	U_MM UNE_MAX F_MM	I IN IMS	I_MAX IN_MAX	P Q S PF	P_MAX Q_MAX S_MAX	P_TRIANGLE		PF_MIN	Cφ_MIN														
U UNE F	U_MM UNE_MAX F_MM																								
I IN IMS	I_MAX IN_MAX																								
P Q S PF	P_MAX Q_MAX S_MAX																								
P_TRIANGLE																									
PF_MIN	Cφ_MIN																								
 Energy Meter contents Standard meters	<table border="1"> <tr> <td> <math>\Sigma P_{I_{IV\_HT}}</math>  <math>\Sigma P_{I_{IV\_NT}}</math>  <math>\Sigma P_{II_{III\_NT}}</math>  <math>\Sigma P_{II_{III\_HT}}</math>  <math>\Sigma Q_{I_{II\_HT}}</math>  <math>\Sigma Q_{I_{II\_NT}}</math>  <math>\Sigma Q_{III_{IV\_HT}}</math>  <math>\Sigma Q_{I_{II\_NT}}</math> </td> </tr> </table>	$\Sigma P_{I_{IV\_HT}}$ $\Sigma P_{I_{IV\_NT}}$ $\Sigma P_{II_{III\_NT}}$ $\Sigma P_{II_{III\_HT}}$ $\Sigma Q_{I_{II\_HT}}$ $\Sigma Q_{I_{II\_NT}}$ $\Sigma Q_{III_{IV\_HT}}$ $\Sigma Q_{I_{II\_NT}}$																							
$\Sigma P_{I_{IV\_HT}}$ $\Sigma P_{I_{IV\_NT}}$ $\Sigma P_{II_{III\_NT}}$ $\Sigma P_{II_{III\_HT}}$ $\Sigma Q_{I_{II\_HT}}$ $\Sigma Q_{I_{II\_NT}}$ $\Sigma Q_{III_{IV\_HT}}$ $\Sigma Q_{I_{II\_NT}}$																									
 Energy Meter contents User meters	<table border="1"> <tr> <td> <math>\Sigma</math>METER1  <math>\Sigma</math>METER2  <math>\Sigma</math>METER3  <math>\Sigma</math>METER4  <math>\Sigma</math>METER5  <math>\Sigma</math>METER6  <math>\Sigma</math>METER7  <math>\Sigma</math>METER8  <math>\Sigma</math>METER9  <math>\Sigma</math>METER10  <math>\Sigma</math>METER11  <math>\Sigma</math>METER12           </td> </tr> </table>	$\Sigma$ METER1 $\Sigma$ METER2 $\Sigma$ METER3 $\Sigma$ METER4 $\Sigma$ METER5 $\Sigma$ METER6 $\Sigma$ METER7 $\Sigma$ METER8 $\Sigma$ METER9 $\Sigma$ METER10 $\Sigma$ METER11 $\Sigma$ METER12																							
$\Sigma$ METER1 $\Sigma$ METER2 $\Sigma$ METER3 $\Sigma$ METER4 $\Sigma$ METER5 $\Sigma$ METER6 $\Sigma$ METER7 $\Sigma$ METER8 $\Sigma$ METER9 $\Sigma$ METER10 $\Sigma$ METER11 $\Sigma$ METER12																									
 Energy Mean-values Power mean-values + trend	<table border="1"> <tr> <td>MT_P_I_IV</td> <td>MT_P_II_III</td> <td>MT_Q_I_II</td> <td>MT_Q_III_IV</td> <td>MT_S</td> </tr> </table>	MT_P_I_IV	MT_P_II_III	MT_Q_I_II	MT_Q_III_IV	MT_S																			
MT_P_I_IV	MT_P_II_III	MT_Q_I_II	MT_Q_III_IV	MT_S																					
 Energy Mean-values User mean-values + trend	<table border="1"> <tr> <td>M1 / TR_M1</td> <td>M1_MM</td> </tr> <tr> <td>M2 / TR_M2</td> <td>M2_MM</td> </tr> <tr> <td>M3 / TR_M3</td> <td>M3_MM</td> </tr> <tr> <td>M4 / TR_M4</td> <td>M4_MM</td> </tr> <tr> <td>M5 / TR_M5</td> <td>M5_MM</td> </tr> <tr> <td>M6 / TR_M6</td> <td>M6_MM</td> </tr> <tr> <td>M7 / TR_M7</td> <td>M7_MM</td> </tr> <tr> <td>M8 / TR_M8</td> <td>M8_MM</td> </tr> <tr> <td>M9 / TR_M9</td> <td>M9_MM</td> </tr> <tr> <td>M10 / TR_M10</td> <td>M10_MM</td> </tr> <tr> <td>M11 / TR_M11</td> <td>M11_MM</td> </tr> <tr> <td>M12 / TR_M12</td> <td>M12_MM</td> </tr> </table>	M1 / TR_M1	M1_MM	M2 / TR_M2	M2_MM	M3 / TR_M3	M3_MM	M4 / TR_M4	M4_MM	M5 / TR_M5	M5_MM	M6 / TR_M6	M6_MM	M7 / TR_M7	M7_MM	M8 / TR_M8	M8_MM	M9 / TR_M9	M9_MM	M10 / TR_M10	M10_MM	M11 / TR_M11	M11_MM	M12 / TR_M12	M12_MM
M1 / TR_M1	M1_MM																								
M2 / TR_M2	M2_MM																								
M3 / TR_M3	M3_MM																								
M4 / TR_M4	M4_MM																								
M5 / TR_M5	M5_MM																								
M6 / TR_M6	M6_MM																								
M7 / TR_M7	M7_MM																								
M8 / TR_M8	M8_MM																								
M9 / TR_M9	M9_MM																								
M10 / TR_M10	M10_MM																								
M11 / TR_M11	M11_MM																								
M12 / TR_M12	M12_MM																								
 Energy Bimetal current	<table border="1"> <tr> <td>IB1 IB2 IB1_MAX IB2_MAX</td> </tr> </table>	IB1 IB2 IB1_MAX IB2_MAX																							
IB1 IB2 IB1_MAX IB2_MAX																									







## B2 Display matrices for split-phase (two-phase) systems

Display menu	Corresponding matrix																																													
 Instantaneous values	<table border="1"> <tr> <td>U1N</td> <td>U1N_MM</td> <td></td> </tr> <tr> <td>U2N</td> <td>U2N_MM</td> <td></td> </tr> <tr> <td>U</td> <td>U_MM</td> <td></td> </tr> <tr> <td>UNE</td> <td>UNE_MAX</td> <td></td> </tr> <tr> <td>I1</td> <td>I1_MAX</td> <td></td> </tr> <tr> <td>I2</td> <td>I2_MAX</td> <td></td> </tr> <tr> <td>IN</td> <td>IN_MAX</td> <td></td> </tr> <tr> <td>IPE</td> <td>IPE_MAX</td> <td></td> </tr> <tr> <td>P</td> <td>P1</td> <td>P_MAX / P1_MAX</td> </tr> <tr> <td>Q</td> <td>P2</td> <td>Q_MAX / P2_MAX</td> </tr> <tr> <td>F</td> <td>Q1</td> <td>S_MAX / Q1_MAX</td> </tr> <tr> <td>PF</td> <td>Q2</td> <td>F_MM / Q2_MAX</td> </tr> <tr> <td>P_TRIANGLE</td> <td>P1_TRIANGLE</td> <td>P2_TRIANGLE</td> </tr> <tr> <td></td> <td></td> <td></td> </tr> <tr> <td>PF_MIN</td> <td>Cφ_MIN</td> <td></td> </tr> </table>	U1N	U1N_MM		U2N	U2N_MM		U	U_MM		UNE	UNE_MAX		I1	I1_MAX		I2	I2_MAX		IN	IN_MAX		IPE	IPE_MAX		P	P1	P_MAX / P1_MAX	Q	P2	Q_MAX / P2_MAX	F	Q1	S_MAX / Q1_MAX	PF	Q2	F_MM / Q2_MAX	P_TRIANGLE	P1_TRIANGLE	P2_TRIANGLE				PF_MIN	Cφ_MIN	
U1N	U1N_MM																																													
U2N	U2N_MM																																													
U	U_MM																																													
UNE	UNE_MAX																																													
I1	I1_MAX																																													
I2	I2_MAX																																													
IN	IN_MAX																																													
IPE	IPE_MAX																																													
P	P1	P_MAX / P1_MAX																																												
Q	P2	Q_MAX / P2_MAX																																												
F	Q1	S_MAX / Q1_MAX																																												
PF	Q2	F_MM / Q2_MAX																																												
P_TRIANGLE	P1_TRIANGLE	P2_TRIANGLE																																												
PF_MIN	Cφ_MIN																																													
 Energy Meter contents Standard meters	<table border="1"> <tr> <td>ΣP_I_IV_HT</td> </tr> <tr> <td>ΣP_I_IV_NT</td> </tr> <tr> <td>ΣP_II_III_NT</td> </tr> <tr> <td>ΣP_II_III_HT</td> </tr> <tr> <td>ΣQ_I_II_HT</td> </tr> <tr> <td>ΣQ_I_II_NT</td> </tr> <tr> <td>ΣQ_III_IV_HT</td> </tr> <tr> <td>ΣQ_I_II_NT</td> </tr> </table>	ΣP_I_IV_HT	ΣP_I_IV_NT	ΣP_II_III_NT	ΣP_II_III_HT	ΣQ_I_II_HT	ΣQ_I_II_NT	ΣQ_III_IV_HT	ΣQ_I_II_NT																																					
ΣP_I_IV_HT																																														
ΣP_I_IV_NT																																														
ΣP_II_III_NT																																														
ΣP_II_III_HT																																														
ΣQ_I_II_HT																																														
ΣQ_I_II_NT																																														
ΣQ_III_IV_HT																																														
ΣQ_I_II_NT																																														
 Energy Meter contents User meters	<table border="1"> <tr> <td>ΣMETER1</td> </tr> <tr> <td>ΣMETER2</td> </tr> <tr> <td>ΣMETER3</td> </tr> <tr> <td>ΣMETER4</td> </tr> <tr> <td>ΣMETER5</td> </tr> <tr> <td>ΣMETER6</td> </tr> <tr> <td>ΣMETER7</td> </tr> <tr> <td>ΣMETER8</td> </tr> <tr> <td>ΣMETER9</td> </tr> <tr> <td>ΣMETER10</td> </tr> <tr> <td>ΣMETER11</td> </tr> <tr> <td>ΣMETER12</td> </tr> </table>	ΣMETER1	ΣMETER2	ΣMETER3	ΣMETER4	ΣMETER5	ΣMETER6	ΣMETER7	ΣMETER8	ΣMETER9	ΣMETER10	ΣMETER11	ΣMETER12																																	
ΣMETER1																																														
ΣMETER2																																														
ΣMETER3																																														
ΣMETER4																																														
ΣMETER5																																														
ΣMETER6																																														
ΣMETER7																																														
ΣMETER8																																														
ΣMETER9																																														
ΣMETER10																																														
ΣMETER11																																														
ΣMETER12																																														
 Energy Mean-values Power mean-values + trend	<table border="1"> <tr> <td>MT_P_I_IV</td> <td>MT_P_II_III</td> <td>MT_Q_I_II</td> <td>MT_Q_III_IV</td> <td>MT_S</td> </tr> </table>	MT_P_I_IV	MT_P_II_III	MT_Q_I_II	MT_Q_III_IV	MT_S																																								
MT_P_I_IV	MT_P_II_III	MT_Q_I_II	MT_Q_III_IV	MT_S																																										
 Energy Mean-values User mean-values + trend	<table border="1"> <tr> <td>M1 / TR_M1</td> <td>M1_MM</td> </tr> <tr> <td>M2 / TR_M2</td> <td>M2_MM</td> </tr> <tr> <td>M3 / TR_M3</td> <td>M3_MM</td> </tr> <tr> <td>M4 / TR_M4</td> <td>M4_MM</td> </tr> <tr> <td>M5 / TR_M5</td> <td>M5_MM</td> </tr> <tr> <td>M6 / TR_M6</td> <td>M6_MM</td> </tr> <tr> <td>M7 / TR_M7</td> <td>M7_MM</td> </tr> <tr> <td>M8 / TR_M8</td> <td>M8_MM</td> </tr> <tr> <td>M9 / TR_M9</td> <td>M9_MM</td> </tr> <tr> <td>M10 / TR_M10</td> <td>M10_MM</td> </tr> <tr> <td>M11 / TR_M11</td> <td>M11_MM</td> </tr> <tr> <td>M12 / TR_M12</td> <td>M12_MM</td> </tr> </table>	M1 / TR_M1	M1_MM	M2 / TR_M2	M2_MM	M3 / TR_M3	M3_MM	M4 / TR_M4	M4_MM	M5 / TR_M5	M5_MM	M6 / TR_M6	M6_MM	M7 / TR_M7	M7_MM	M8 / TR_M8	M8_MM	M9 / TR_M9	M9_MM	M10 / TR_M10	M10_MM	M11 / TR_M11	M11_MM	M12 / TR_M12	M12_MM																					
M1 / TR_M1	M1_MM																																													
M2 / TR_M2	M2_MM																																													
M3 / TR_M3	M3_MM																																													
M4 / TR_M4	M4_MM																																													
M5 / TR_M5	M5_MM																																													
M6 / TR_M6	M6_MM																																													
M7 / TR_M7	M7_MM																																													
M8 / TR_M8	M8_MM																																													
M9 / TR_M9	M9_MM																																													
M10 / TR_M10	M10_MM																																													
M11 / TR_M11	M11_MM																																													
M12 / TR_M12	M12_MM																																													
 Energy Bimetal current	<table border="1"> <tr> <td>IB1</td> </tr> <tr> <td>IB2</td> </tr> <tr> <td>IB1_MAX</td> </tr> <tr> <td>IB2_MAX</td> </tr> </table>	IB1	IB2	IB1_MAX	IB2_MAX																																									
IB1																																														
IB2																																														
IB1_MAX																																														
IB2_MAX																																														

### B3 Display matrices for 3-wire system, balanced load







Display menu	Corresponding matrix																								
 Instantaneous values	<table border="1"> <tr> <td>U12 U23 U31 F</td> <td>U12_MM U23_MM U31_MM F_MM</td> <td>UR1 UR2 UR2R1 UR21_MAX</td> </tr> <tr> <td>I I_MAX</td> <td></td> <td></td> </tr> <tr> <td>P Q S PF</td> <td>P_MAX Q_MAX S_MAX</td> <td></td> </tr> <tr> <td>P_TRIANGLE</td> <td></td> <td></td> </tr> <tr> <td>PF_MIN</td> <td>C<math>\phi</math>_MIN</td> <td></td> </tr> </table>	U12 U23 U31 F	U12_MM U23_MM U31_MM F_MM	UR1 UR2 UR2R1 UR21_MAX	I I_MAX			P Q S PF	P_MAX Q_MAX S_MAX		P_TRIANGLE			PF_MIN	C $\phi$ _MIN										
U12 U23 U31 F	U12_MM U23_MM U31_MM F_MM	UR1 UR2 UR2R1 UR21_MAX																							
I I_MAX																									
P Q S PF	P_MAX Q_MAX S_MAX																								
P_TRIANGLE																									
PF_MIN	C $\phi$ _MIN																								
 Energy Meter contents Standard meters	<table border="1"> <tr> <td> <math>\Sigma</math>P_I_IV_HT  <math>\Sigma</math>P_I_IV_NT  <math>\Sigma</math>P_II_III_NT  <math>\Sigma</math>P_II_III_HT  <math>\Sigma</math>Q_I_II_HT  <math>\Sigma</math>Q_I_II_NT  <math>\Sigma</math>Q_III_IV_HT  <math>\Sigma</math>Q_I_II_NT                             </td> </tr> </table>	$\Sigma$ P_I_IV_HT $\Sigma$ P_I_IV_NT $\Sigma$ P_II_III_NT $\Sigma$ P_II_III_HT $\Sigma$ Q_I_II_HT $\Sigma$ Q_I_II_NT $\Sigma$ Q_III_IV_HT $\Sigma$ Q_I_II_NT																							
$\Sigma$ P_I_IV_HT $\Sigma$ P_I_IV_NT $\Sigma$ P_II_III_NT $\Sigma$ P_II_III_HT $\Sigma$ Q_I_II_HT $\Sigma$ Q_I_II_NT $\Sigma$ Q_III_IV_HT $\Sigma$ Q_I_II_NT																									
 Energy Meter contents User meters	<table border="1"> <tr> <td> <math>\Sigma</math>METER1  <math>\Sigma</math>METER2  <math>\Sigma</math>METER3  <math>\Sigma</math>METER4  <math>\Sigma</math>METER5  <math>\Sigma</math>METER6  <math>\Sigma</math>METER7  <math>\Sigma</math>METER8  <math>\Sigma</math>METER9  <math>\Sigma</math>METER10  <math>\Sigma</math>METER11  <math>\Sigma</math>METER12                             </td> </tr> </table>	$\Sigma$ METER1 $\Sigma$ METER2 $\Sigma$ METER3 $\Sigma$ METER4 $\Sigma$ METER5 $\Sigma$ METER6 $\Sigma$ METER7 $\Sigma$ METER8 $\Sigma$ METER9 $\Sigma$ METER10 $\Sigma$ METER11 $\Sigma$ METER12																							
$\Sigma$ METER1 $\Sigma$ METER2 $\Sigma$ METER3 $\Sigma$ METER4 $\Sigma$ METER5 $\Sigma$ METER6 $\Sigma$ METER7 $\Sigma$ METER8 $\Sigma$ METER9 $\Sigma$ METER10 $\Sigma$ METER11 $\Sigma$ METER12																									
 Energy Mean-values Power mean-values + trend	<table border="1"> <tr> <td>MT_P_I_IV</td> <td>MT_P_II_III</td> <td>MT_Q_I_II</td> <td>MT_Q_III_IV</td> <td>MT_S</td> </tr> </table>	MT_P_I_IV	MT_P_II_III	MT_Q_I_II	MT_Q_III_IV	MT_S																			
MT_P_I_IV	MT_P_II_III	MT_Q_I_II	MT_Q_III_IV	MT_S																					
 Energy Mean-values User mean-values + trend	<table border="1"> <tr> <td>M1 / TR_M1</td> <td>M1_MM</td> </tr> <tr> <td>M2 / TR_M2</td> <td>M2_MM</td> </tr> <tr> <td>M3 / TR_M3</td> <td>M3_MM</td> </tr> <tr> <td>M4 / TR_M4</td> <td>M4_MM</td> </tr> <tr> <td>M5 / TR_M5</td> <td>M5_MM</td> </tr> <tr> <td>M6 / TR_M6</td> <td>M6_MM</td> </tr> <tr> <td>M7 / TR_M7</td> <td>M7_MM</td> </tr> <tr> <td>M8 / TR_M8</td> <td>M8_MM</td> </tr> <tr> <td>M9 / TR_M9</td> <td>M9_MM</td> </tr> <tr> <td>M10 / TR_M10</td> <td>M10_MM</td> </tr> <tr> <td>M11 / TR_M11</td> <td>M11_MM</td> </tr> <tr> <td>M12 / TR_M12</td> <td>M12_MM</td> </tr> </table>	M1 / TR_M1	M1_MM	M2 / TR_M2	M2_MM	M3 / TR_M3	M3_MM	M4 / TR_M4	M4_MM	M5 / TR_M5	M5_MM	M6 / TR_M6	M6_MM	M7 / TR_M7	M7_MM	M8 / TR_M8	M8_MM	M9 / TR_M9	M9_MM	M10 / TR_M10	M10_MM	M11 / TR_M11	M11_MM	M12 / TR_M12	M12_MM
M1 / TR_M1	M1_MM																								
M2 / TR_M2	M2_MM																								
M3 / TR_M3	M3_MM																								
M4 / TR_M4	M4_MM																								
M5 / TR_M5	M5_MM																								
M6 / TR_M6	M6_MM																								
M7 / TR_M7	M7_MM																								
M8 / TR_M8	M8_MM																								
M9 / TR_M9	M9_MM																								
M10 / TR_M10	M10_MM																								
M11 / TR_M11	M11_MM																								
M12 / TR_M12	M12_MM																								
 Energy Bimetal current	<table border="1"> <tr> <td>IB IB_MAX</td> </tr> </table>	IB IB_MAX																							
IB IB_MAX																									

## B4 Display matrices for 3-wire system, balanced load, phase shift







Display menu	Corresponding matrix																								
 Instantaneous values	<table border="1"> <tr> <td>U</td> <td>U_MM</td> </tr> <tr> <td>I</td> <td>I_MAX</td> </tr> <tr> <td>P</td> <td>P_MAX</td> </tr> <tr> <td>F</td> <td>F_MM</td> </tr> <tr> <td>P</td> <td>P_MAX</td> </tr> <tr> <td>Q</td> <td>Q_MAX</td> </tr> <tr> <td>S</td> <td>S_MAX</td> </tr> <tr> <td>PF</td> <td></td> </tr> <tr> <td>P_TRIANGLE</td> <td></td> </tr> <tr> <td>PF_MIN</td> <td>Cφ_MIN</td> </tr> </table>	U	U_MM	I	I_MAX	P	P_MAX	F	F_MM	P	P_MAX	Q	Q_MAX	S	S_MAX	PF		P_TRIANGLE		PF_MIN	Cφ_MIN				
U	U_MM																								
I	I_MAX																								
P	P_MAX																								
F	F_MM																								
P	P_MAX																								
Q	Q_MAX																								
S	S_MAX																								
PF																									
P_TRIANGLE																									
PF_MIN	Cφ_MIN																								
 Energy Meter contents Standard meters	<table border="1"> <tr> <td>ΣP_I_IV_HT</td> </tr> <tr> <td>ΣP_I_IV_NT</td> </tr> <tr> <td>ΣP_II_III_NT</td> </tr> <tr> <td>ΣP_II_III_HT</td> </tr> <tr> <td>ΣQ_I_II_HT</td> </tr> <tr> <td>ΣQ_I_II_NT</td> </tr> <tr> <td>ΣQ_III_IV_HT</td> </tr> <tr> <td>ΣQ_I_II_NT</td> </tr> </table>	ΣP_I_IV_HT	ΣP_I_IV_NT	ΣP_II_III_NT	ΣP_II_III_HT	ΣQ_I_II_HT	ΣQ_I_II_NT	ΣQ_III_IV_HT	ΣQ_I_II_NT																
ΣP_I_IV_HT																									
ΣP_I_IV_NT																									
ΣP_II_III_NT																									
ΣP_II_III_HT																									
ΣQ_I_II_HT																									
ΣQ_I_II_NT																									
ΣQ_III_IV_HT																									
ΣQ_I_II_NT																									
 Energy Meter contents User meters	<table border="1"> <tr> <td>ΣMETER1</td> </tr> <tr> <td>ΣMETER2</td> </tr> <tr> <td>ΣMETER3</td> </tr> <tr> <td>ΣMETER4</td> </tr> <tr> <td>ΣMETER5</td> </tr> <tr> <td>ΣMETER6</td> </tr> <tr> <td>ΣMETER7</td> </tr> <tr> <td>ΣMETER8</td> </tr> <tr> <td>ΣMETER9</td> </tr> <tr> <td>ΣMETER10</td> </tr> <tr> <td>ΣMETER11</td> </tr> <tr> <td>ΣMETER12</td> </tr> </table>	ΣMETER1	ΣMETER2	ΣMETER3	ΣMETER4	ΣMETER5	ΣMETER6	ΣMETER7	ΣMETER8	ΣMETER9	ΣMETER10	ΣMETER11	ΣMETER12												
ΣMETER1																									
ΣMETER2																									
ΣMETER3																									
ΣMETER4																									
ΣMETER5																									
ΣMETER6																									
ΣMETER7																									
ΣMETER8																									
ΣMETER9																									
ΣMETER10																									
ΣMETER11																									
ΣMETER12																									
 Energy Mean-values Power mean-values + trend	<table border="1"> <tr> <td>MT_P_I_IV</td> <td>MT_P_II_III</td> <td>MT_Q_I_II</td> <td>MT_Q_III_IV</td> <td>MT_S</td> </tr> </table>	MT_P_I_IV	MT_P_II_III	MT_Q_I_II	MT_Q_III_IV	MT_S																			
MT_P_I_IV	MT_P_II_III	MT_Q_I_II	MT_Q_III_IV	MT_S																					
 Energy Mean-values User mean-values + trend	<table border="1"> <tr> <td>M1 / TR_M1</td> <td>M1_MM</td> </tr> <tr> <td>M2 / TR_M2</td> <td>M2_MM</td> </tr> <tr> <td>M3 / TR_M3</td> <td>M3_MM</td> </tr> <tr> <td>M4 / TR_M4</td> <td>M4_MM</td> </tr> <tr> <td>M5 / TR_M5</td> <td>M5_MM</td> </tr> <tr> <td>M6 / TR_M6</td> <td>M6_MM</td> </tr> <tr> <td>M7 / TR_M7</td> <td>M7_MM</td> </tr> <tr> <td>M8 / TR_M8</td> <td>M8_MM</td> </tr> <tr> <td>M9 / TR_M9</td> <td>M9_MM</td> </tr> <tr> <td>M10 / TR_M10</td> <td>M10_MM</td> </tr> <tr> <td>M11 / TR_M11</td> <td>M11_MM</td> </tr> <tr> <td>M12 / TR_M12</td> <td>M12_MM</td> </tr> </table>	M1 / TR_M1	M1_MM	M2 / TR_M2	M2_MM	M3 / TR_M3	M3_MM	M4 / TR_M4	M4_MM	M5 / TR_M5	M5_MM	M6 / TR_M6	M6_MM	M7 / TR_M7	M7_MM	M8 / TR_M8	M8_MM	M9 / TR_M9	M9_MM	M10 / TR_M10	M10_MM	M11 / TR_M11	M11_MM	M12 / TR_M12	M12_MM
M1 / TR_M1	M1_MM																								
M2 / TR_M2	M2_MM																								
M3 / TR_M3	M3_MM																								
M4 / TR_M4	M4_MM																								
M5 / TR_M5	M5_MM																								
M6 / TR_M6	M6_MM																								
M7 / TR_M7	M7_MM																								
M8 / TR_M8	M8_MM																								
M9 / TR_M9	M9_MM																								
M10 / TR_M10	M10_MM																								
M11 / TR_M11	M11_MM																								
M12 / TR_M12	M12_MM																								
 Energy Bimetal current	<table border="1"> <tr> <td>IB</td> </tr> <tr> <td>IB_MAX</td> </tr> </table>	IB	IB_MAX																						
IB																									
IB_MAX																									









## B5 Display matrices for 3-wire systems, unbalanced load

Display menu	Corresponding matrix															
<div style="border: 1px solid green; padding: 5px; display: inline-block;">  Instantaneous values         </div>	<table border="1" style="width: 100%; border-collapse: collapse;"> <tr> <td>U12 U23 U31 F</td> <td>U12_MM U23_MM U31_MM F_MM</td> <td>UR1 UR2 UR2R1 UR21_MAX</td> </tr> <tr> <td>I1 I2 I3 IPE</td> <td>I1_MAX I2_MAX I3_MAX IPE_MAX</td> <td>IR1 IR2 IR2R1 IR21_MAX</td> </tr> <tr> <td>P Q S PF</td> <td>P_MAX Q_MAX S_MAX</td> <td></td> </tr> <tr> <td>P_TRIANGLE</td> <td></td> <td></td> </tr> <tr> <td>PF_MIN</td> <td>Cφ_MIN</td> <td></td> </tr> </table>	U12 U23 U31 F	U12_MM U23_MM U31_MM F_MM	UR1 UR2 UR2R1 UR21_MAX	I1 I2 I3 IPE	I1_MAX I2_MAX I3_MAX IPE_MAX	IR1 IR2 IR2R1 IR21_MAX	P Q S PF	P_MAX Q_MAX S_MAX		P_TRIANGLE			PF_MIN	Cφ_MIN	
U12 U23 U31 F	U12_MM U23_MM U31_MM F_MM	UR1 UR2 UR2R1 UR21_MAX														
I1 I2 I3 IPE	I1_MAX I2_MAX I3_MAX IPE_MAX	IR1 IR2 IR2R1 IR21_MAX														
P Q S PF	P_MAX Q_MAX S_MAX															
P_TRIANGLE																
PF_MIN	Cφ_MIN															
<div style="border: 1px solid green; padding: 5px; display: inline-block;">  Energy         </div> <div style="border: 1px solid green; padding: 5px; display: inline-block; margin-left: 20px;">Meter contents</div> <div style="border: 1px solid green; padding: 5px; display: inline-block; margin-left: 40px;">Standard meters</div>	<table border="1" style="width: 100%; border-collapse: collapse;"> <tr> <td>           ΣP_I_IV_HT            ΣP_I_IV_NT            ΣP_II_III_NT            ΣP_II_III_HT            ΣQ_I_II_HT            ΣQ_I_II_NT            ΣQ_III_IV_HT            ΣQ_I_II_NT         </td> </tr> </table>	ΣP_I_IV_HT ΣP_I_IV_NT ΣP_II_III_NT ΣP_II_III_HT ΣQ_I_II_HT ΣQ_I_II_NT ΣQ_III_IV_HT ΣQ_I_II_NT														
ΣP_I_IV_HT ΣP_I_IV_NT ΣP_II_III_NT ΣP_II_III_HT ΣQ_I_II_HT ΣQ_I_II_NT ΣQ_III_IV_HT ΣQ_I_II_NT																
<div style="border: 1px solid green; padding: 5px; display: inline-block;">  Energy         </div> <div style="border: 1px solid green; padding: 5px; display: inline-block; margin-left: 20px;">Meter contents</div> <div style="border: 1px solid green; padding: 5px; display: inline-block; margin-left: 40px;">User meters</div>	<table border="1" style="width: 100%; border-collapse: collapse;"> <tr> <td>           ΣMETER1            ΣMETER2            ΣMETER3            ΣMETER4            ΣMETER5            ΣMETER6            ΣMETER7            ΣMETER8            ΣMETER9            ΣMETER10            ΣMETER11            ΣMETER12         </td> </tr> </table>	ΣMETER1 ΣMETER2 ΣMETER3 ΣMETER4 ΣMETER5 ΣMETER6 ΣMETER7 ΣMETER8 ΣMETER9 ΣMETER10 ΣMETER11 ΣMETER12														
ΣMETER1 ΣMETER2 ΣMETER3 ΣMETER4 ΣMETER5 ΣMETER6 ΣMETER7 ΣMETER8 ΣMETER9 ΣMETER10 ΣMETER11 ΣMETER12																
<div style="border: 1px solid green; padding: 5px; display: inline-block;">  Energy         </div> <div style="border: 1px solid green; padding: 5px; display: inline-block; margin-left: 20px;">Mean-values</div> <div style="border: 1px solid green; padding: 5px; display: inline-block; margin-left: 40px;">Power mean-values + trend</div>	<table border="1" style="width: 100%; border-collapse: collapse;"> <tr> <td>MT_P_I_IV</td> <td>MT_P_II_III</td> <td>MT_Q_I_II</td> <td>MT_Q_III_IV</td> <td>MT_S</td> </tr> </table>	MT_P_I_IV	MT_P_II_III	MT_Q_I_II	MT_Q_III_IV	MT_S										
MT_P_I_IV	MT_P_II_III	MT_Q_I_II	MT_Q_III_IV	MT_S												
<div style="border: 1px solid green; padding: 5px; display: inline-block;">  Energy         </div> <div style="border: 1px solid green; padding: 5px; display: inline-block; margin-left: 20px;">Mean-values</div> <div style="border: 1px solid green; padding: 5px; display: inline-block; margin-left: 40px;">User mean-values + trend</div>	<table border="1" style="width: 100%; border-collapse: collapse;"> <tr> <td>M1 / TR_M1 M2 / TR_M2 M3 / TR_M3 M4 / TR_M4</td> <td>M1_MM M2_MM M3_MM M4_MM</td> </tr> <tr> <td>M5 / TR_M5 M6 / TR_M6 M7 / TR_M7 M8 / TR_M8</td> <td>M5_MM M6_MM M7_MM M8_MM</td> </tr> <tr> <td>M9 / TR_M9 M10 / TR_M10 M11 / TR_M11 M12 / TR_M12</td> <td>M9_MM M10_MM M11_MM M12_MM</td> </tr> </table>	M1 / TR_M1 M2 / TR_M2 M3 / TR_M3 M4 / TR_M4	M1_MM M2_MM M3_MM M4_MM	M5 / TR_M5 M6 / TR_M6 M7 / TR_M7 M8 / TR_M8	M5_MM M6_MM M7_MM M8_MM	M9 / TR_M9 M10 / TR_M10 M11 / TR_M11 M12 / TR_M12	M9_MM M10_MM M11_MM M12_MM									
M1 / TR_M1 M2 / TR_M2 M3 / TR_M3 M4 / TR_M4	M1_MM M2_MM M3_MM M4_MM															
M5 / TR_M5 M6 / TR_M6 M7 / TR_M7 M8 / TR_M8	M5_MM M6_MM M7_MM M8_MM															
M9 / TR_M9 M10 / TR_M10 M11 / TR_M11 M12 / TR_M12	M9_MM M10_MM M11_MM M12_MM															
<div style="border: 1px solid green; padding: 5px; display: inline-block;">  Energy         </div> <div style="border: 1px solid green; padding: 5px; display: inline-block; margin-left: 20px;">Bimetal current</div>	<table border="1" style="width: 100%; border-collapse: collapse;"> <tr> <td>IB1 IB2 IB3</td> <td>IB1_MAX IB2_MAX IB3_MAX</td> </tr> </table>	IB1 IB2 IB3	IB1_MAX IB2_MAX IB3_MAX													
IB1 IB2 IB3	IB1_MAX IB2_MAX IB3_MAX															







## B6 Display matrices for 3-wire systems, unbalanced load, Aron

Display menu	Corresponding matrix															
 Instantaneous values	<table border="1"> <tr> <td>U12 U23 U31 F</td> <td>U12_MM U23_MM U31_MM F_MM</td> <td>UR1 UR2 UR2R1 UR21_MAX</td> </tr> <tr> <td>I1 I2 I3 IMS</td> <td>I1_MAX I2_MAX I3_MAX</td> <td></td> </tr> <tr> <td>P Q S PF</td> <td>P_MAX Q_MAX S_MAX</td> <td></td> </tr> <tr> <td>P_TRIANGLE</td> <td></td> <td></td> </tr> <tr> <td>PF_MIN</td> <td>Cφ_MIN</td> <td></td> </tr> </table>	U12 U23 U31 F	U12_MM U23_MM U31_MM F_MM	UR1 UR2 UR2R1 UR21_MAX	I1 I2 I3 IMS	I1_MAX I2_MAX I3_MAX		P Q S PF	P_MAX Q_MAX S_MAX		P_TRIANGLE			PF_MIN	Cφ_MIN	
U12 U23 U31 F	U12_MM U23_MM U31_MM F_MM	UR1 UR2 UR2R1 UR21_MAX														
I1 I2 I3 IMS	I1_MAX I2_MAX I3_MAX															
P Q S PF	P_MAX Q_MAX S_MAX															
P_TRIANGLE																
PF_MIN	Cφ_MIN															
 Energy Meter contents Standard meters	<table border="1"> <tr> <td>ΣP_I_IV_HT ΣP_I_IV_NT ΣP_II_III_NT ΣP_II_III_HT ΣQ_I_II_HT ΣQ_I_II_NT ΣQ_III_IV_HT ΣQ_I_II_NT</td> </tr> </table>	ΣP_I_IV_HT ΣP_I_IV_NT ΣP_II_III_NT ΣP_II_III_HT ΣQ_I_II_HT ΣQ_I_II_NT ΣQ_III_IV_HT ΣQ_I_II_NT														
ΣP_I_IV_HT ΣP_I_IV_NT ΣP_II_III_NT ΣP_II_III_HT ΣQ_I_II_HT ΣQ_I_II_NT ΣQ_III_IV_HT ΣQ_I_II_NT																
 Energy Meter contents User meters	<table border="1"> <tr> <td>ΣMETER1 ΣMETER2 ΣMETER3 ΣMETER4 ΣMETER5 ΣMETER6 ΣMETER7 ΣMETER8 ΣMETER9 ΣMETER10 ΣMETER11 ΣMETER12</td> </tr> </table>	ΣMETER1 ΣMETER2 ΣMETER3 ΣMETER4 ΣMETER5 ΣMETER6 ΣMETER7 ΣMETER8 ΣMETER9 ΣMETER10 ΣMETER11 ΣMETER12														
ΣMETER1 ΣMETER2 ΣMETER3 ΣMETER4 ΣMETER5 ΣMETER6 ΣMETER7 ΣMETER8 ΣMETER9 ΣMETER10 ΣMETER11 ΣMETER12																
 Energy Mean-values Power mean-values + trend	<table border="1"> <tr> <td>MT_P_I_IV</td> <td>MT_P_II_III</td> <td>MT_Q_I_II</td> <td>MT_Q_III_IV</td> <td>MT_S</td> </tr> </table>	MT_P_I_IV	MT_P_II_III	MT_Q_I_II	MT_Q_III_IV	MT_S										
MT_P_I_IV	MT_P_II_III	MT_Q_I_II	MT_Q_III_IV	MT_S												
 Energy Mean-values User mean-values + trend	<table border="1"> <tr> <td>M1 / TR_M1 M2 / TR_M2 M3 / TR_M3 M4 / TR_M4</td> <td>M1_MM M2_MM M3_MM M4_MM</td> </tr> <tr> <td>M5 / TR_M5 M6 / TR_M6 M7 / TR_M7 M8 / TR_M8</td> <td>M5_MM M6_MM M7_MM M8_MM</td> </tr> <tr> <td>M9 / TR_M9 M10 / TR_M10 M11 / TR_M11 M12 / TR_M12</td> <td>M9_MM M10_MM M11_MM M12_MM</td> </tr> </table>	M1 / TR_M1 M2 / TR_M2 M3 / TR_M3 M4 / TR_M4	M1_MM M2_MM M3_MM M4_MM	M5 / TR_M5 M6 / TR_M6 M7 / TR_M7 M8 / TR_M8	M5_MM M6_MM M7_MM M8_MM	M9 / TR_M9 M10 / TR_M10 M11 / TR_M11 M12 / TR_M12	M9_MM M10_MM M11_MM M12_MM									
M1 / TR_M1 M2 / TR_M2 M3 / TR_M3 M4 / TR_M4	M1_MM M2_MM M3_MM M4_MM															
M5 / TR_M5 M6 / TR_M6 M7 / TR_M7 M8 / TR_M8	M5_MM M6_MM M7_MM M8_MM															
M9 / TR_M9 M10 / TR_M10 M11 / TR_M11 M12 / TR_M12	M9_MM M10_MM M11_MM M12_MM															
 Energy Bimetal current	<table border="1"> <tr> <td>IB1 IB2 IB3</td> <td>IB1_MAX IB2_MAX IB3_MAX</td> </tr> </table>	IB1 IB2 IB3	IB1_MAX IB2_MAX IB3_MAX													
IB1 IB2 IB3	IB1_MAX IB2_MAX IB3_MAX															







## B7 Display matrices for 4-wire system, balanced load

Display menu	Corresponding matrix																								
 Instantaneous values	<table border="1"> <tr> <td>U UNE I F</td> <td>U_MM UNE_MAX I_MAX F_MM</td> </tr> <tr> <td>P Q S PF</td> <td>P_MAX Q_MAX S_MAX</td> </tr> <tr> <td>P_TRIANGLE</td> <td></td> </tr> <tr> <td>PF_MIN</td> <td>Cφ_MIN</td> </tr> </table>	U UNE I F	U_MM UNE_MAX I_MAX F_MM	P Q S PF	P_MAX Q_MAX S_MAX	P_TRIANGLE		PF_MIN	Cφ_MIN																
U UNE I F	U_MM UNE_MAX I_MAX F_MM																								
P Q S PF	P_MAX Q_MAX S_MAX																								
P_TRIANGLE																									
PF_MIN	Cφ_MIN																								
 Energy Meter contents Standard meters	<table border="1"> <tr> <td> <math>\Sigma P_{I_{IV\_HT}}</math>  <math>\Sigma P_{I_{IV\_NT}}</math>  <math>\Sigma P_{II_{III\_NT}}</math>  <math>\Sigma P_{II_{III\_HT}}</math>  <math>\Sigma Q_{I_{II\_HT}}</math>  <math>\Sigma Q_{I_{II\_NT}}</math>  <math>\Sigma Q_{III_{IV\_HT}}</math>  <math>\Sigma Q_{I_{II\_NT}}</math> </td> </tr> </table>	$\Sigma P_{I_{IV\_HT}}$ $\Sigma P_{I_{IV\_NT}}$ $\Sigma P_{II_{III\_NT}}$ $\Sigma P_{II_{III\_HT}}$ $\Sigma Q_{I_{II\_HT}}$ $\Sigma Q_{I_{II\_NT}}$ $\Sigma Q_{III_{IV\_HT}}$ $\Sigma Q_{I_{II\_NT}}$																							
$\Sigma P_{I_{IV\_HT}}$ $\Sigma P_{I_{IV\_NT}}$ $\Sigma P_{II_{III\_NT}}$ $\Sigma P_{II_{III\_HT}}$ $\Sigma Q_{I_{II\_HT}}$ $\Sigma Q_{I_{II\_NT}}$ $\Sigma Q_{III_{IV\_HT}}$ $\Sigma Q_{I_{II\_NT}}$																									
 Energy Meter contents User meters	<table border="1"> <tr> <td> <math>\Sigma METER1</math>  <math>\Sigma METER2</math>  <math>\Sigma METER3</math>  <math>\Sigma METER4</math>  <math>\Sigma METER5</math>  <math>\Sigma METER6</math>  <math>\Sigma METER7</math>  <math>\Sigma METER8</math>  <math>\Sigma METER9</math>  <math>\Sigma METER10</math>  <math>\Sigma METER11</math>  <math>\Sigma METER12</math> </td> </tr> </table>	$\Sigma METER1$ $\Sigma METER2$ $\Sigma METER3$ $\Sigma METER4$ $\Sigma METER5$ $\Sigma METER6$ $\Sigma METER7$ $\Sigma METER8$ $\Sigma METER9$ $\Sigma METER10$ $\Sigma METER11$ $\Sigma METER12$																							
$\Sigma METER1$ $\Sigma METER2$ $\Sigma METER3$ $\Sigma METER4$ $\Sigma METER5$ $\Sigma METER6$ $\Sigma METER7$ $\Sigma METER8$ $\Sigma METER9$ $\Sigma METER10$ $\Sigma METER11$ $\Sigma METER12$																									
 Energy Mean-values Power mean-values + trend	<table border="1"> <tr> <td>MT_P_I_IV</td> <td>MT_P_II_III</td> <td>MT_Q_I_II</td> <td>MT_Q_III_IV</td> <td>MT_S</td> </tr> </table>	MT_P_I_IV	MT_P_II_III	MT_Q_I_II	MT_Q_III_IV	MT_S																			
MT_P_I_IV	MT_P_II_III	MT_Q_I_II	MT_Q_III_IV	MT_S																					
 Energy Mean-values User mean-values + trend	<table border="1"> <tr> <td>M1 / TR_M1</td> <td>M1_MM</td> </tr> <tr> <td>M2 / TR_M2</td> <td>M2_MM</td> </tr> <tr> <td>M3 / TR_M3</td> <td>M3_MM</td> </tr> <tr> <td>M4 / TR_M4</td> <td>M4_MM</td> </tr> <tr> <td>M5 / TR_M5</td> <td>M5_MM</td> </tr> <tr> <td>M6 / TR_M6</td> <td>M6_MM</td> </tr> <tr> <td>M7 / TR_M7</td> <td>M7_MM</td> </tr> <tr> <td>M8 / TR_M8</td> <td>M8_MM</td> </tr> <tr> <td>M9 / TR_M9</td> <td>M9_MM</td> </tr> <tr> <td>M10 / TR_M10</td> <td>M10_MM</td> </tr> <tr> <td>M11 / TR_M11</td> <td>M11_MM</td> </tr> <tr> <td>M12 / TR_M12</td> <td>M12_MM</td> </tr> </table>	M1 / TR_M1	M1_MM	M2 / TR_M2	M2_MM	M3 / TR_M3	M3_MM	M4 / TR_M4	M4_MM	M5 / TR_M5	M5_MM	M6 / TR_M6	M6_MM	M7 / TR_M7	M7_MM	M8 / TR_M8	M8_MM	M9 / TR_M9	M9_MM	M10 / TR_M10	M10_MM	M11 / TR_M11	M11_MM	M12 / TR_M12	M12_MM
M1 / TR_M1	M1_MM																								
M2 / TR_M2	M2_MM																								
M3 / TR_M3	M3_MM																								
M4 / TR_M4	M4_MM																								
M5 / TR_M5	M5_MM																								
M6 / TR_M6	M6_MM																								
M7 / TR_M7	M7_MM																								
M8 / TR_M8	M8_MM																								
M9 / TR_M9	M9_MM																								
M10 / TR_M10	M10_MM																								
M11 / TR_M11	M11_MM																								
M12 / TR_M12	M12_MM																								
 Energy Bimetal current	<table border="1"> <tr> <td>IB IB_MAX</td> </tr> </table>	IB IB_MAX																							
IB IB_MAX																									

## B8 Display matrices for 4-wire systems, unbalanced load

Display menu	Corresponding matrix																												
 Instantaneous values	<table border="1"> <tr> <td>U1N U2N U3N UNE</td> <td>U12 U23 U31 F</td> <td>U1N_MM / U12_MM U2N_MM / U23_MM U3N_MM / U31_MM F_MM / UR21_MAX</td> <td>UR1 UR2 U0 UNB_UR2_UR1</td> </tr> <tr> <td>I1 I2 I3 F</td> <td>IN IPE IMS</td> <td>I1_MAX / IN_MAX I2_MAX / IPE_MAX I3_MAX / IR21_MAX</td> <td>IR1 IR2 I0 UNB_IR2_IR1</td> </tr> <tr> <td>P Q S PF</td> <td>P1 P2 P3 P</td> <td>Q1 Q2 Q3 Q</td> <td>S1 S2 S3 S</td> </tr> <tr> <td></td> <td>P1_MAX P2_MAX P3_MAX P_MAX</td> <td>Q1_MAX Q2_MAX Q3_MAX Q_MAX</td> <td>S1_MAX S2_MAX S3_MAX S_MAX</td> </tr> <tr> <td colspan="2">P_TRIANGLE</td> <td>P1_TRIANGLE</td> <td>P2_TRIANGLE</td> </tr> <tr> <td colspan="2"></td> <td colspan="2">P3_TRIANGLE</td> </tr> <tr> <td colspan="2">PF_MIN</td> <td colspan="2">Cφ_MIN</td> </tr> </table>	U1N U2N U3N UNE	U12 U23 U31 F	U1N_MM / U12_MM U2N_MM / U23_MM U3N_MM / U31_MM F_MM / UR21_MAX	UR1 UR2 U0 UNB_UR2_UR1	I1 I2 I3 F	IN IPE IMS	I1_MAX / IN_MAX I2_MAX / IPE_MAX I3_MAX / IR21_MAX	IR1 IR2 I0 UNB_IR2_IR1	P Q S PF	P1 P2 P3 P	Q1 Q2 Q3 Q	S1 S2 S3 S		P1_MAX P2_MAX P3_MAX P_MAX	Q1_MAX Q2_MAX Q3_MAX Q_MAX	S1_MAX S2_MAX S3_MAX S_MAX	P_TRIANGLE		P1_TRIANGLE	P2_TRIANGLE			P3_TRIANGLE		PF_MIN		Cφ_MIN	
U1N U2N U3N UNE	U12 U23 U31 F	U1N_MM / U12_MM U2N_MM / U23_MM U3N_MM / U31_MM F_MM / UR21_MAX	UR1 UR2 U0 UNB_UR2_UR1																										
I1 I2 I3 F	IN IPE IMS	I1_MAX / IN_MAX I2_MAX / IPE_MAX I3_MAX / IR21_MAX	IR1 IR2 I0 UNB_IR2_IR1																										
P Q S PF	P1 P2 P3 P	Q1 Q2 Q3 Q	S1 S2 S3 S																										
	P1_MAX P2_MAX P3_MAX P_MAX	Q1_MAX Q2_MAX Q3_MAX Q_MAX	S1_MAX S2_MAX S3_MAX S_MAX																										
P_TRIANGLE		P1_TRIANGLE	P2_TRIANGLE																										
		P3_TRIANGLE																											
PF_MIN		Cφ_MIN																											
 Energy Meter contents Standard meters	<table border="1"> <tr> <td>           ΣP_I_IV_HT            ΣP_I_IV_NT            ΣP_II_III_NT            ΣP_II_III_HT            ΣQ_I_II_HT            ΣQ_I_II_NT            ΣQ_III_IV_HT            ΣQ_I_II_NT         </td> </tr> </table>	ΣP_I_IV_HT ΣP_I_IV_NT ΣP_II_III_NT ΣP_II_III_HT ΣQ_I_II_HT ΣQ_I_II_NT ΣQ_III_IV_HT ΣQ_I_II_NT																											
ΣP_I_IV_HT ΣP_I_IV_NT ΣP_II_III_NT ΣP_II_III_HT ΣQ_I_II_HT ΣQ_I_II_NT ΣQ_III_IV_HT ΣQ_I_II_NT																													
 Energy Meter contents User meters	<table border="1"> <tr> <td>           ΣMETER1            ΣMETER2            ΣMETER3            ΣMETER4            ΣMETER5            ΣMETER6            ΣMETER7            ΣMETER8            ΣMETER9            ΣMETER10            ΣMETER11            ΣMETER12         </td> </tr> </table>	ΣMETER1 ΣMETER2 ΣMETER3 ΣMETER4 ΣMETER5 ΣMETER6 ΣMETER7 ΣMETER8 ΣMETER9 ΣMETER10 ΣMETER11 ΣMETER12																											
ΣMETER1 ΣMETER2 ΣMETER3 ΣMETER4 ΣMETER5 ΣMETER6 ΣMETER7 ΣMETER8 ΣMETER9 ΣMETER10 ΣMETER11 ΣMETER12																													
 Energy Mean-values Power mean-values + trend	<table border="1"> <tr> <td>MT_P_I_IV</td> <td>MT_P_II_III</td> <td>MT_Q_I_II</td> <td>MT_Q_III_IV</td> <td>MT_S</td> </tr> </table>	MT_P_I_IV	MT_P_II_III	MT_Q_I_II	MT_Q_III_IV	MT_S																							
MT_P_I_IV	MT_P_II_III	MT_Q_I_II	MT_Q_III_IV	MT_S																									
 Energy Mean-values User mean-values + trend	<table border="1"> <tr> <td>M1 / TR_M1</td> <td>M1_MM</td> </tr> <tr> <td>M2 / TR_M2</td> <td>M2_MM</td> </tr> <tr> <td>M3 / TR_M3</td> <td>M3_MM</td> </tr> <tr> <td>M4 / TR_M4</td> <td>M4_MM</td> </tr> <tr> <td>M5 / TR_M5</td> <td>M5_MM</td> </tr> <tr> <td>M6 / TR_M6</td> <td>M6_MM</td> </tr> <tr> <td>M7 / TR_M7</td> <td>M7_MM</td> </tr> <tr> <td>M8 / TR_M8</td> <td>M8_MM</td> </tr> <tr> <td>M9 / TR_M9</td> <td>M9_MM</td> </tr> <tr> <td>M10 / TR_M10</td> <td>M10_MM</td> </tr> <tr> <td>M11 / TR_M11</td> <td>M11_MM</td> </tr> <tr> <td>M12 / TR_M12</td> <td>M12_MM</td> </tr> </table>	M1 / TR_M1	M1_MM	M2 / TR_M2	M2_MM	M3 / TR_M3	M3_MM	M4 / TR_M4	M4_MM	M5 / TR_M5	M5_MM	M6 / TR_M6	M6_MM	M7 / TR_M7	M7_MM	M8 / TR_M8	M8_MM	M9 / TR_M9	M9_MM	M10 / TR_M10	M10_MM	M11 / TR_M11	M11_MM	M12 / TR_M12	M12_MM				
M1 / TR_M1	M1_MM																												
M2 / TR_M2	M2_MM																												
M3 / TR_M3	M3_MM																												
M4 / TR_M4	M4_MM																												
M5 / TR_M5	M5_MM																												
M6 / TR_M6	M6_MM																												
M7 / TR_M7	M7_MM																												
M8 / TR_M8	M8_MM																												
M9 / TR_M9	M9_MM																												
M10 / TR_M10	M10_MM																												
M11 / TR_M11	M11_MM																												
M12 / TR_M12	M12_MM																												
 Energy Bimetal current	<table border="1"> <tr> <td>IB1</td> <td>IB1_MAX</td> </tr> <tr> <td>IB2</td> <td>IB2_MAX</td> </tr> <tr> <td>IB3</td> <td>IB3_MAX</td> </tr> </table>	IB1	IB1_MAX	IB2	IB2_MAX	IB3	IB3_MAX																						
IB1	IB1_MAX																												
IB2	IB2_MAX																												
IB3	IB3_MAX																												

## B8 Display matrices for 4-wire system, unbalanced load, Open-Y

Display menu	Corresponding matrix																								
<div style="border: 1px solid green; padding: 2px; display: inline-block;">  Instantaneous values         </div>	<table border="1" style="width: 100%; border-collapse: collapse;"> <tr> <td style="width: 25%;">U1N U2N U3N UNE</td> <td style="width: 25%;">U12 U23 U31 F</td> <td style="width: 25%;">U1N_MM / U12_MM U2N_MM / U23_MM U3N_MM / U31_MM UNE_MAX / F_MM</td> <td style="width: 25%;"></td> </tr> <tr> <td>I1 I2 I3 F</td> <td>IN IPE IMS</td> <td>I1_MAX / IN_MAX I2_MAX / IPE_MAX I3_MAX / IR21_MAX</td> <td>IR1 IR2 I0 UNB_IR2_IR1</td> </tr> <tr> <td>P Q S PF</td> <td>P1 P2 P3 P</td> <td>Q1 Q2 Q3 Q</td> <td>S1 S2 S3 S</td> </tr> <tr> <td></td> <td>P1_MAX P2_MAX P3_MAX P_MAX</td> <td>Q1_MAX Q2_MAX Q3_MAX Q_MAX</td> <td>S1_MAX S2_MAX S3_MAX S_MAX</td> </tr> <tr> <td>P_TRIANGLE</td> <td>P1_TRIANGLE</td> <td>P2_TRIANGLE</td> <td>P3_TRIANGLE</td> </tr> <tr> <td>PF_MIN</td> <td>Cφ_MIN</td> <td></td> <td></td> </tr> </table>	U1N U2N U3N UNE	U12 U23 U31 F	U1N_MM / U12_MM U2N_MM / U23_MM U3N_MM / U31_MM UNE_MAX / F_MM		I1 I2 I3 F	IN IPE IMS	I1_MAX / IN_MAX I2_MAX / IPE_MAX I3_MAX / IR21_MAX	IR1 IR2 I0 UNB_IR2_IR1	P Q S PF	P1 P2 P3 P	Q1 Q2 Q3 Q	S1 S2 S3 S		P1_MAX P2_MAX P3_MAX P_MAX	Q1_MAX Q2_MAX Q3_MAX Q_MAX	S1_MAX S2_MAX S3_MAX S_MAX	P_TRIANGLE	P1_TRIANGLE	P2_TRIANGLE	P3_TRIANGLE	PF_MIN	Cφ_MIN		
U1N U2N U3N UNE	U12 U23 U31 F	U1N_MM / U12_MM U2N_MM / U23_MM U3N_MM / U31_MM UNE_MAX / F_MM																							
I1 I2 I3 F	IN IPE IMS	I1_MAX / IN_MAX I2_MAX / IPE_MAX I3_MAX / IR21_MAX	IR1 IR2 I0 UNB_IR2_IR1																						
P Q S PF	P1 P2 P3 P	Q1 Q2 Q3 Q	S1 S2 S3 S																						
	P1_MAX P2_MAX P3_MAX P_MAX	Q1_MAX Q2_MAX Q3_MAX Q_MAX	S1_MAX S2_MAX S3_MAX S_MAX																						
P_TRIANGLE	P1_TRIANGLE	P2_TRIANGLE	P3_TRIANGLE																						
PF_MIN	Cφ_MIN																								
<div style="border: 1px solid green; padding: 2px; display: inline-block;">  Energy         </div> <div style="border: 1px solid green; padding: 2px; display: inline-block; margin-left: 20px;">Meter contents</div> <div style="border: 1px solid green; padding: 2px; display: inline-block; margin-left: 20px;">Standard meters</div>	<table border="1" style="width: 100%; border-collapse: collapse;"> <tr> <td>           ΣP_I_IV_HT            ΣP_I_IV_NT            ΣP_II_III_NT            ΣP_II_III_HT            ΣQ_I_II_HT            ΣQ_I_II_NT            ΣQ_III_IV_HT            ΣQ_I_II_NT         </td> </tr> </table>	ΣP_I_IV_HT ΣP_I_IV_NT ΣP_II_III_NT ΣP_II_III_HT ΣQ_I_II_HT ΣQ_I_II_NT ΣQ_III_IV_HT ΣQ_I_II_NT																							
ΣP_I_IV_HT ΣP_I_IV_NT ΣP_II_III_NT ΣP_II_III_HT ΣQ_I_II_HT ΣQ_I_II_NT ΣQ_III_IV_HT ΣQ_I_II_NT																									
<div style="border: 1px solid green; padding: 2px; display: inline-block;">  Energy         </div> <div style="border: 1px solid green; padding: 2px; display: inline-block; margin-left: 20px;">Meter contents</div> <div style="border: 1px solid green; padding: 2px; display: inline-block; margin-left: 20px;">User meters</div>	<table border="1" style="width: 100%; border-collapse: collapse;"> <tr> <td>           ΣMETER1            ΣMETER2            ΣMETER3            ΣMETER4            ΣMETER5            ΣMETER6            ΣMETER7            ΣMETER8            ΣMETER9            ΣMETER10            ΣMETER11            ΣMETER12         </td> </tr> </table>	ΣMETER1 ΣMETER2 ΣMETER3 ΣMETER4 ΣMETER5 ΣMETER6 ΣMETER7 ΣMETER8 ΣMETER9 ΣMETER10 ΣMETER11 ΣMETER12																							
ΣMETER1 ΣMETER2 ΣMETER3 ΣMETER4 ΣMETER5 ΣMETER6 ΣMETER7 ΣMETER8 ΣMETER9 ΣMETER10 ΣMETER11 ΣMETER12																									
<div style="border: 1px solid green; padding: 2px; display: inline-block;">  Energy         </div> <div style="border: 1px solid green; padding: 2px; display: inline-block; margin-left: 20px;">Mean-values</div> <div style="border: 1px solid green; padding: 2px; display: inline-block; margin-left: 20px;">Power mean-values + trend</div>	<table border="1" style="width: 100%; border-collapse: collapse;"> <tr> <td style="width: 20%;">MT_P_I_IV</td> <td style="width: 20%;">MT_P_II_III</td> <td style="width: 20%;">MT_Q_I_II</td> <td style="width: 20%;">MT_Q_III_IV</td> <td style="width: 20%;">MT_S</td> </tr> </table>	MT_P_I_IV	MT_P_II_III	MT_Q_I_II	MT_Q_III_IV	MT_S																			
MT_P_I_IV	MT_P_II_III	MT_Q_I_II	MT_Q_III_IV	MT_S																					
<div style="border: 1px solid green; padding: 2px; display: inline-block;">  Energy         </div> <div style="border: 1px solid green; padding: 2px; display: inline-block; margin-left: 20px;">Mean-values</div> <div style="border: 1px solid green; padding: 2px; display: inline-block; margin-left: 20px;">User mean-values + trend</div>	<table border="1" style="width: 100%; border-collapse: collapse;"> <tr> <td style="width: 50%;">M1 / TR_M1 M2 / TR_M2 M3 / TR_M3 M4 / TR_M4</td> <td style="width: 50%;">M1_MM M2_MM M3_MM M4_MM</td> </tr> <tr> <td>M5 / TR_M5 M6 / TR_M6 M7 / TR_M7 M8 / TR_M8</td> <td>M5_MM M6_MM M7_MM M8_MM</td> </tr> <tr> <td>M9 / TR_M9 M10 / TR_M10 M11 / TR_M11 M12 / TR_M12</td> <td>M9_MM M10_MM M11_MM M12_MM</td> </tr> </table>	M1 / TR_M1 M2 / TR_M2 M3 / TR_M3 M4 / TR_M4	M1_MM M2_MM M3_MM M4_MM	M5 / TR_M5 M6 / TR_M6 M7 / TR_M7 M8 / TR_M8	M5_MM M6_MM M7_MM M8_MM	M9 / TR_M9 M10 / TR_M10 M11 / TR_M11 M12 / TR_M12	M9_MM M10_MM M11_MM M12_MM																		
M1 / TR_M1 M2 / TR_M2 M3 / TR_M3 M4 / TR_M4	M1_MM M2_MM M3_MM M4_MM																								
M5 / TR_M5 M6 / TR_M6 M7 / TR_M7 M8 / TR_M8	M5_MM M6_MM M7_MM M8_MM																								
M9 / TR_M9 M10 / TR_M10 M11 / TR_M11 M12 / TR_M12	M9_MM M10_MM M11_MM M12_MM																								
<div style="border: 1px solid green; padding: 2px; display: inline-block;">  Energy         </div> <div style="border: 1px solid green; padding: 2px; display: inline-block; margin-left: 20px;">Bimetal current</div>	<table border="1" style="width: 100%; border-collapse: collapse;"> <tr> <td style="width: 50%;">IB1 IB2 IB3</td> <td style="width: 50%;">IB1_MAX IB2_MAX IB3_MAX</td> </tr> </table>	IB1 IB2 IB3	IB1_MAX IB2_MAX IB3_MAX																						
IB1 IB2 IB3	IB1_MAX IB2_MAX IB3_MAX																								

## C Logic functions

The principal function of the logical gates is given in the following table, for simplicity shown for gates with two inputs only.

function	symbol	older symbols		truth table	plain text
		ANSI 91-1984	DIN 40700 (alt)		
<b>AND</b>				<b>A</b> <b>B</b> <b>Y</b>	Function is true if all input conditions are fulfilled
				0 0 0	
				0 1 0	
				1 0 0	
				1 1 1	
<b>NAND</b>				<b>A</b> <b>B</b> <b>Y</b>	Function is true if at least one of the input conditions is <b>not</b> fulfilled
				0 0 1	
				0 1 1	
				1 0 1	
				1 1 0	
<b>OR</b>				<b>A</b> <b>B</b> <b>Y</b>	Function is true if at least one of the input conditions is fulfilled
				0 0 0	
				0 1 1	
				1 0 1	
				1 1 1	
<b>NOR</b>				<b>A</b> <b>B</b> <b>Y</b>	Function is true if <b>none</b> of the input conditions is fulfilled
				0 0 1	
				0 1 0	
				1 0 0	
				1 1 0	

Using DIRECT or INVERT the input is directly connected to the output of a monitoring function, without need for a logical combination. For these functions only one input is used.

<b>DIRECT</b>		<table border="1"> <thead> <tr> <th>A</th> <th>Y</th> </tr> </thead> <tbody> <tr> <td>0</td> <td>0</td> </tr> <tr> <td>1</td> <td>1</td> </tr> </tbody> </table>	A	Y	0	0	1	1	The monitoring function is reduced to one input only. The state of the output corresponds to the input.
A	Y								
0	0								
1	1								
<b>INVERT</b>		<table border="1"> <thead> <tr> <th>A</th> <th>Y</th> </tr> </thead> <tbody> <tr> <td>0</td> <td>1</td> </tr> <tr> <td>1</td> <td>0</td> </tr> </tbody> </table>	A	Y	0	1	1	0	The monitoring function is reduced to one input only. The state of the output corresponds to the inverted input.
A	Y								
0	1								
1	0								

## D FCC statement

The following statement applies to the products covered in this manual, unless otherwise specified herein. The statement for other products will appear in the accompanying documentation.

NOTE: This equipment has been tested and found to comply with the limits for a Class A digital device, pursuant to Part 15 of the FCC Rules and meets all requirements of the Canadian Interference-Causing Equipment Standard ICES-003 for digital apparatus. These limits are designed to provide reasonable protection against harmful interference in a residential installation. This equipment generates, uses, and can radiate radio frequency energy and, if not installed and used in accordance with the instructions, may cause harmful interference to radio communications. However, there is no guarantee that interference will not occur in a particular installation. If this equipment does cause harmful interference to radio or television reception, which can be determined by turning the equipment off and on, the user is encouraged to try to correct the interference by one or more of the following measures:

- Reorient or relocate the receiving antenna.
- Increase the separation between the equipment and receiver.
- Connect the equipment into an outlet on a circuit different from that to which the receiver is connected.
- Consult the dealer or an experienced radio/T.V. technician for help.

Camille Bauer AG is not responsible for any radio television interference caused by unauthorized modifications of this equipment or the substitution or attachment of connecting cables and equipment other than those specified by Camille Bauer AG. The correction of interference caused by such unauthorized modification, substitution or attachment will be the responsibility of the user.

# INDEX

## A

Alarming ..... 38

## C

Commissioning ..... 26

Configuration

    menu ..... 35

cosφ ..... 58

## D

Demounting ..... 7

Device overview ..... 6

Dimensional drawing ..... 56

Display matrices ..... 65

Disturbance recorder ..... 45

Driving a counter mechanism ..... 23

## E

Electrical connections

    analog outputs ..... 24

    Aron connection ..... 18

    cross sections ..... 9

    digital input ..... 22

    digital output ..... 23

    I/O extensions ..... 9

    inputs ..... 10

    Modbus interface ..... 24

    Open-Y ..... 20

    power supply ..... 22

    relays ..... 22

    split phase ..... 21

Ethernet installation ..... 28

## F

FCC statement ..... 79

Firewall ..... 30

## I

I, II, III, IV ..... 34

Installation check ..... 27

## L

Logic components

    AND ..... 78

    DIRECT ..... 78

    INVERT ..... 78

    NAND ..... 78

    NOR ..... 78

    OR ..... 78

Logic functions ..... 78

## M

Measured quantities ..... 57

    Basic measurements ..... 57

    Bimetal current ..... 63

    earth fault monitoring ..... 60

    harmonic analysis ..... 61

    Load factors ..... 59

    mean values and trend ..... 63

    meters ..... 64

    system imbalance ..... 62

    zero displacement voltage ..... 60

Measurement displays ..... 33

Measurements

    reset ..... 35

Mechanical mounting ..... 7

Menu operation ..... 32

Mounting ..... 7

## N

NTP ..... 29

## O

Operating elements ..... 32

## R

Reactive power ..... 59

Resetting measurements ..... 35

Roman numbers ..... 34

## S

Safety notes ..... 6

Scope of supply ..... 5

SD card

    Exchange ..... 47

    LED ..... 47

SD-Card ..... 47

Security system ..... 31

Service and maintenance ..... 49

Summary alarm ..... 40

Symbols ..... 34

Symmetrical components ..... 62

## T

Technical data ..... 50

Time synchronization ..... 29

## U

UPS (Uninterruptible power supply) ..... 25

## Z

Zero suppression ..... 51



По вопросам продажи и поддержки обращайтесь:

Архангельск (8182)63-90-72  
Астана (7172)727-132  
Астрахань (8512)99-46-04  
Барнаул (3852)73-04-60  
Белгород (4722)40-23-64  
Брянск (4832)59-03-52  
Владивосток (423)249-28-31  
Волгоград (844)278-03-48  
Вологда (8172)26-41-59  
Воронеж (473)204-51-73  
Екатеринбург (343)384-55-89  
Иваново (4932)77-34-06  
Ижевск (3412)26-03-58  
Казань (843)206-01-48

Калининград (4012)72-03-81  
Калуга (4842)92-23-67  
Кемерово (3842)65-04-62  
Киров (8332)68-02-04  
Краснодар (861)203-40-90  
Красноярск (391)204-63-61  
Курск (4712)77-13-04  
Липецк (4742)52-20-81  
Магнитогорск (3519)55-03-13  
Москва (495)268-04-70  
Мурманск (8152)59-64-93  
Набережные Челны (8552)20-53-41  
Нижний Новгород (831)429-08-12  
Новокузнецк (3843)20-46-81

Новосибирск (383)227-86-73  
Омск (3812)21-46-40  
Орел (4862)44-53-42  
Оренбург (3532)37-68-04  
Пенза (8412)22-31-16  
Пермь (342)205-81-47  
Ростов-на-Дону (863)308-18-15  
Рязань (4912)46-61-64  
Самара (846)206-03-16  
Санкт-Петербург (812)309-46-40  
Саратов (845)249-38-78  
Севастополь (8692)22-31-93  
Симферополь (3652)67-13-56  
Смоленск (4812)29-41-54

Сочи (862)225-72-31  
Ставрополь (8652)20-65-13  
Сургут (3462)77-98-35  
Тверь (4822)63-31-35  
Томск (3822)98-41-53  
Тула (4872)74-02-29  
Тюмень (3452)66-21-18  
Ульяновск (8422)24-23-59  
Уфа (347)229-48-12  
Хабаровск (4212)92-98-04  
Челябинск (351)202-03-61  
Череповец (8202)49-02-64  
Ярославль (4852)69-52-93

Единый адрес для всех регионов: [cmn@nt-rt.ru](mailto:cmn@nt-rt.ru) || [www.camille-bauer.nt-rt.ru](http://www.camille-bauer.nt-rt.ru)

PROCESS CONTROL ENGINEERING



ANGULAR POSITION ENGINEERING



HEAVY CURRENT ENGINEERING

