



Многофункциональный преобразователь APLUS

Архангельск (8182)63-90-72
Астана (7172)727-132
Астрахань (8512)99-46-04
Барнаул (3852)73-04-60
Белгород (4722)40-23-64
Брянск (4832)59-03-52
Владивосток (423)249-28-31
Волгоград (844)278-03-48
Вологда (8172)26-41-59
Воронеж (473)204-51-73
Екатеринбург (343)384-55-89
Иваново (4932)77-34-06
Ижевск (3412)26-03-58
Казань (843)206-01-48

Калининград (4012)72-03-81
Калуга (4842)92-23-67
Кемерово (3842)65-04-62
Киров (8332)68-02-04
Краснодар (861)203-40-90
Красноярск (391)204-63-61
Курск (4712)77-13-04
Липецк (4742)52-20-81
Магнитогорск (3519)55-03-13
Москва (495)268-04-70
Мурманск (8152)59-64-93
Набережные Челны (8552)20-53-41
Нижний Новгород (831)429-08-12
Новокузнецк (3843)20-46-81

Новосибирск (383)227-86-73
Омск (3812)21-46-40
Орел (4862)44-53-42
Оренбург (3532)37-68-04
Пенза (8412)22-31-16
Пермь (342)205-81-47
Ростов-на-Дону (863)308-18-15
Рязань (4912)46-61-64
Самара (846)206-03-16
Санкт-Петербург (812)309-46-40
Саратов (845)249-38-78
Севастополь (8692)22-31-93
Симферополь (3652)67-13-56
Смоленск (4812)29-41-54

Сочи (862)225-72-31
Ставрополь (8652)20-65-13
Сургут (3462)77-98-35
Тверь (4822)63-31-35
Томск (3822)98-41-53
Тула (4872)74-02-29
Тюмень (3452)66-21-18
Ульяновск (8422)24-23-59
Уфа (347)229-48-12
Хабаровск (4212)92-98-04
Челябинск (351)202-03-61
Череповец (8202)49-02-64
Ярославль (4852)69-52-93

Единый адрес для всех регионов: cmn@nt-rt.ru || www.camille-bauer.nt-rt.ru

использовано с разрешения официального
дистрибьютора АО «ЮЕ-Интернейшнл»

Legal information

Warning notices

In this document warning notices are used, which you have to observe to ensure personal safety and to prevent damage to property. Depending on the degree of danger the following symbols are used:



If the warning notice is not followed death or severe personal injury **will** result.



If the warning notice is not followed damage to property or severe personal injury **may** result.



If the warning notice is not followed the device **may** be damaged or **may** not fulfill the expected functionality.

Qualified personnel

The product described in this document may be handled by personnel only, which is qualified for the respective task. Qualified personnel have the training and experience to identify risks and potential hazards when working with the product. Qualified personnel are also able to understand and follow the given safety and warning notices.

Intended use

The product described in this document may be used only for the application specified. The maximum electrical supply data and ambient conditions specified in the technical data section must be adhered. For the perfect and safe operation of the device proper transport and storage as well as professional assembly, installation, handling and maintenance are required.

Disclaimer of liability

The content of this document has been reviewed to ensure correctness. Nevertheless it may contain errors or inconsistencies and we cannot guarantee completeness and correctness. This is especially true for different language versions of this document. This document is regularly reviewed and updated.

Contents

1. Introduction	5
1.1 Purpose of this document	5
1.2 Scope of supply	5
1.3 Further documents	5
2. Security notes	6
3. Device overview	6
3.1 Brief description	6
3.2 Possible modes of operation	7
3.3 Monitoring and alarming	8
3.3.1 Alarming concept	8
3.3.2 Logic components	10
3.3.3 Limit values	11
3.3.4 Sequence of evaluation	12
3.4 Free Modbus image	13
4. Mechanical mounting	14
4.1 Panel cutout	14
4.2 Mounting of the device	14
4.3 Demounting of the device	14
5. Electrical connections	15
5.1 General safety notes	15
5.2 Electrical connections of the I/Os	16
5.3 Possible cross sections and tightening torques	16
5.4 Inputs	17
5.5 Rogowski current inputs	21
5.6 Power supply	22
5.7 Relays	22
5.8 Digital inputs and outputs	23
5.9 Analog outputs	25
5.10 Modbus interface RS485 X4 and / or X8	25
5.11 Profibus DP interface	26
6. Commissioning	27
6.1 Software installation CB-Manager	27
6.2 Parametrization of the device functionality	28
6.3 Installation check	29
6.4 Installation of Ethernet devices	30
6.4.1 Connection	30
6.4.2 Network installation using the CB-Manager software	31
6.4.3 Network installation by means of local programming	32
6.4.4 Time synchronization via NTP-protocol	33
6.4.5 TCP ports for data transmission	33
6.5 Installation of Profibus DP devices	34
6.6 Protection against device data changing	35
7. Operating the device	36
7.1 Display and operating elements	36
7.2 Operating modes	37
7.3 Setting the display brightness	38
7.4 Display modes	39

7.6 Alarm handling	43
7.6.1 Alarm state display on the device	43
7.6.2 Display of alarm texts	43
7.6.3 Acknowledgment of alarms via display	44
7.7 Resetting of measurements	45
7.8 Configuration	46
7.8.1 Selection of the parameter to edit	50
7.8.2 Discrete selection	51
7.8.3 Setting value	51
7.9 Data logger	52
7.9.1 Activation of data logger recording	52
7.9.2 SD card	52
7.9.3 Access to logger data	53
7.9.4 Logger data analysis	53
8. Service, maintenance and disposal	54
8.1 Protection of data integrity	54
8.2 Calibration and new adjustment	54
8.3 Cleaning.	54
8.4 Battery	54
8.5 Disposal.	54
9. Technical data	55
10. Dimensional drawings	60
Annex	62
A Description of measured quantities	62
A1 Basic measurements	62
A2 Harmonic analysis	65
A3 System imbalance	66
A4 Reactive power	67
A5 Mean values and trend	69
A6 Meters	70
B Display matrices in FULL mode	71
B0 Used abbreviations for the measurements	71
B1 Display matrix single phase system	78
B2 Display matrix Split-phase (two-phase) systems	79
B3 Display matrix 3-wire system, balanced load	80
B4 Display matrix 3-wire systems, unbalanced load	81
B5 Display matrix 3-wire systems, unbalanced load, Aron	82
B6 Display matrix 4-wire system, balanced load	83
B7 Display matrix 4-wire systems, unbalanced load	84
B8 Display matrix 4-wire system, unbalanced load, Open-Y	85
B9 Display matrix of mean-values of power quantities	86
C FCC statement	87
INDEX	88

1. Introduction

1.1 Purpose of this document

This document describes the universal measurement device for heavy-current quantities *APLUS*. It is intended to be used by:

- Installation personnel and commissioning engineers
- Service and maintenance personnel
- Planners

Scope

This handbook is valid for all hardware versions of the *APLUS* with LED display or without display. Some of the functions described in this document are available only, if the necessary optional components are included in the device.

Required knowledge

A general knowledge in the field of electrical engineering is required. For assembly and installation of the device knowledge of applicable national safety regulations and installation standard is required.

1.2 Scope of supply

- Measurement device *APLUS*
- Safety instructions (multiple languages)
- Connection set basic unit: Plug-in terminals and mounting clamps
- Optional: Connection set I/O extension: Plug-in terminals

1.3 Further documents

- Safety instructions *APLUS*
- Data sheet *APLUS*
- Modbus basics: General description of the communication protocol
- Modbus interface *APLUS*: Register description of Modbus/RTU communication via RS-485
- Modbus/TCP interface *APLUS*: Register description of Modbus/TCP communication via Ethernet

2. Security notes



Device may only be disposed in a professional manner !

The installation and commissioning should only be carried out by trained personnel.

Check the following points before commissioning:

- that the maximum values for all the connections are not exceeded, see "Technical data" section,
- that the connection wires are not damaged, and that they are not live during wiring,
- that the power flow direction and the phase rotation are correct.

The instrument must be taken out of service if safe operation is no longer possible (e.g. visible damage). In this case, all the connections must be switched off. The instrument must be returned to the factory or to an authorized service dealer.

It is forbidden to open the housing and to make modifications to the instrument. The instrument is not equipped with an integrated circuit breaker. During installation check that a labeled switch is installed and that it can easily be reached by the operators.

Unauthorized repair or alteration of the unit invalidates the warranty.

3. Device overview

3.1 Brief description

The *APLUS* is a comprehensive instrument for the universal measurement, monitoring and power quality analysis in power systems. The device can be adapted fast and easily to the measurement task by means of the CB-Manager software. The universal measurement system of the device may be used directly for any power system, from single phase up to 4-wire unbalanced networks, without hardware modifications. Independent of measurement task and outer influences always the same high performance is achieved.

Using additional, optional components the opportunities of the *APLUS* may be extended. You may choose from I/O extensions, communication interfaces or data logger. The nameplate on the device gives further details about the present version.

The version with top-hat rail adapter instead of the display has the same dimensions and connections as the version with display and supports the same options.

3.2 Possible modes of operation

The *APLUS* can cover a wide range of possible input ranges without any hardware variance. The adaption to the input signal is performed by means of variable amplifying levels for current and voltage inputs. Depending on the application it makes sense to fix these levels by means of the configuration or to let them stay variable to achieve a maximum accuracy during measurement. The differentiation, if the amplifying remains constant or is adapted to the present value, is done during the definition of the input configuration by means of the parameter "auto-scaling".

The disadvantage of auto-scaling is that when an amplifying level needs to be changed, a settling time of at least one cycle of the power frequency must be allowed until the signals have stabilized again. During this short time the measurement results remain frozen.

Continuous measurement

An absolute uninterrupted measurement of all quantities assumes that auto-scaling is deactivated for both voltage and current inputs.

Metering

The uncertainty of the active energy meters of the *APLUS* is given with class 0.5S. To fulfill the high requirements of the underlying meter standard EN 62053-22 also small currents have to be measured very accurate. To do so, auto-scaling must be activated for current inputs. For metering applications the system voltage is assumed to be quite constant, nominal value acc. standard, wherefore auto-scaling for voltages is not required. The subsequent example shows an appropriate configuration, which also conforms to the factory setting of the device.

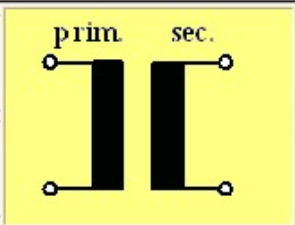
System		4-wire system, asymmetrical			
		<input checked="" type="checkbox"/> right-hand rotation			
voltage input		400.00	V	400.00	[V]
L - L	max.	480.00		480.00	
current input		5.00	A	5.00	[A]
	max.	6.00		6.00	
					
	Overriding		Auto-scaling		
voltage		20.00 %		<input type="checkbox"/>	
current		20.00 %		<input checked="" type="checkbox"/>	

Dynamic monitoring of limit values

An important criterion when monitoring the quality of the supply voltage is the possibility to detect short sags of the system voltage. To be able to follow the progress of the voltage auto-scaling of the voltage inputs should be deactivated. Thereby you have to consider that a possible swell of the voltage may be detected only up to the configured overriding (20% of rated voltage in the above example), because the switching of the measurement range is locked in both directions.

This applies analogously to all quantities of the system, whose progress should be monitored. For power quantities the voltage amplification as well as the current amplification is influenced. However, which basic quantities may vary how much can differ from application to application.

3.3 Monitoring and alarming

The logic module integrated in the *APLUS* is a powerful feature to monitor critical situations without delay on device side. By implementing this local intelligence a safe monitoring can be realized which is independent of the readiness of the control system.

3.3.1 Alarming concept

How alarms are handled is decided during the configuration of the device. For that in the logic module you can define if LED's are used for alarm state display and how resp. when a possibly activated action, such as the switching of a relay, will be reset. These configuration parameters are highlighted in yellow in the following chart.

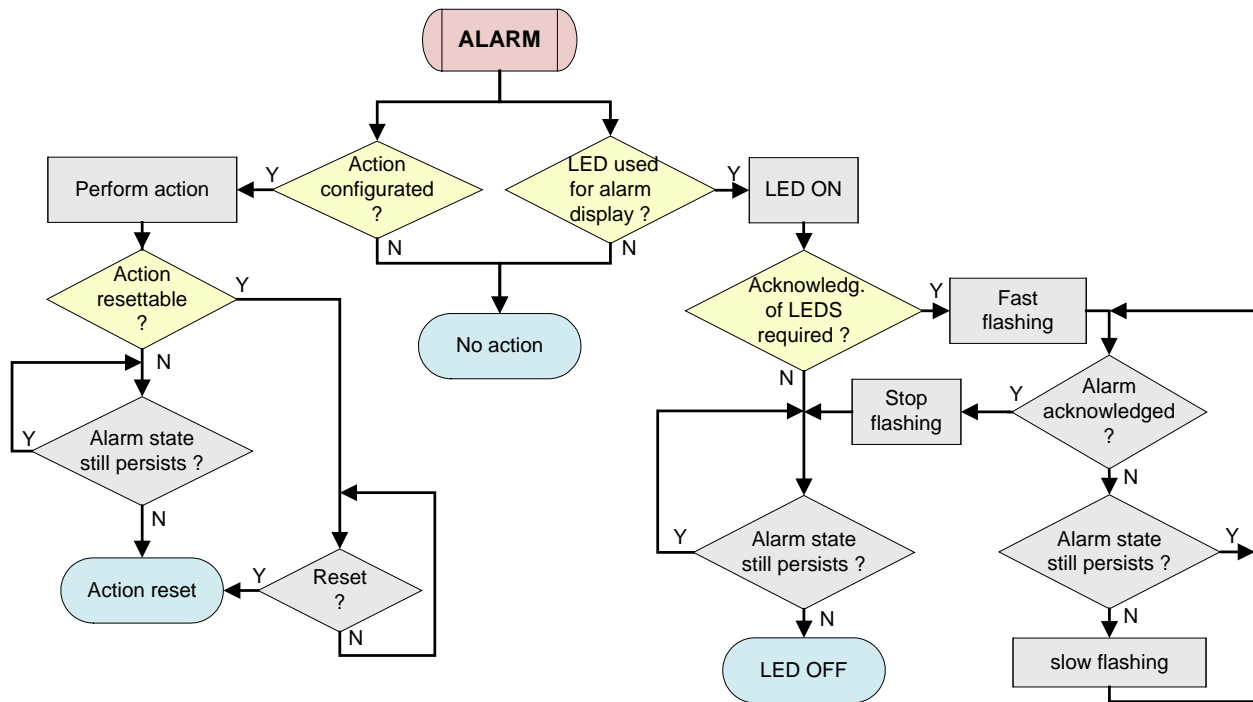

► **Acknowledgment:** This procedure affects the state of the LED only

If an alarm state is visualized via LED, its occurrence must be acknowledged via display ([see: Acknowledgment of alarms via display](#)), no matter if it is still active (fast flashing) or has dropped-out already (slow flashing). By acknowledging an alarm, only the flashing of the LED stops, but a reset of the alarm action is performed only if the display is configured as a possible source for alarm reset.

i Acknowledgment is not required if "acknowledgement of alarm LEDs required" in the logic module configuration is not selected.

► **Alarm reset:** This procedure affects the states of the follow-up action and the LEDs

If an alarm state occurs a follow-up action (e.g. the switching of a relay) can be triggered. This follow-up action is normally reset as soon as the alarm condition no longer exists. But the alarm handling may be configured as well in a way that only by means of an alarm reset the subsequent operation is withdrawn. This way an alarm remains stored until a reset is performed, even if the alarm situation no longer exists. Possible sources for an alarm reset are the display, a digital input, another logical state of the logic module or a command via the bus interface.

Hint: If an alarm is reset, the alarm state visualized via LED is acknowledged at the same time.

On the next page some signal flow examples are shown.

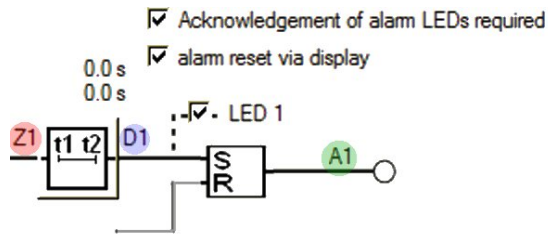

- Z:** Logic output determined from all involved logic inputs
- D:** Corresponds to signal Z, delayed by the switch-in resp. dropout delay
- A:** Output signal of the logic function
- S:** State of the subsequent operation (e.g. of a relay), corresponds normally to A, but may be inverted (subsequent operation: relay OFF)

1) Alarm reset inactive, switch-in and dropout delay 3s, follow-up action not inverted

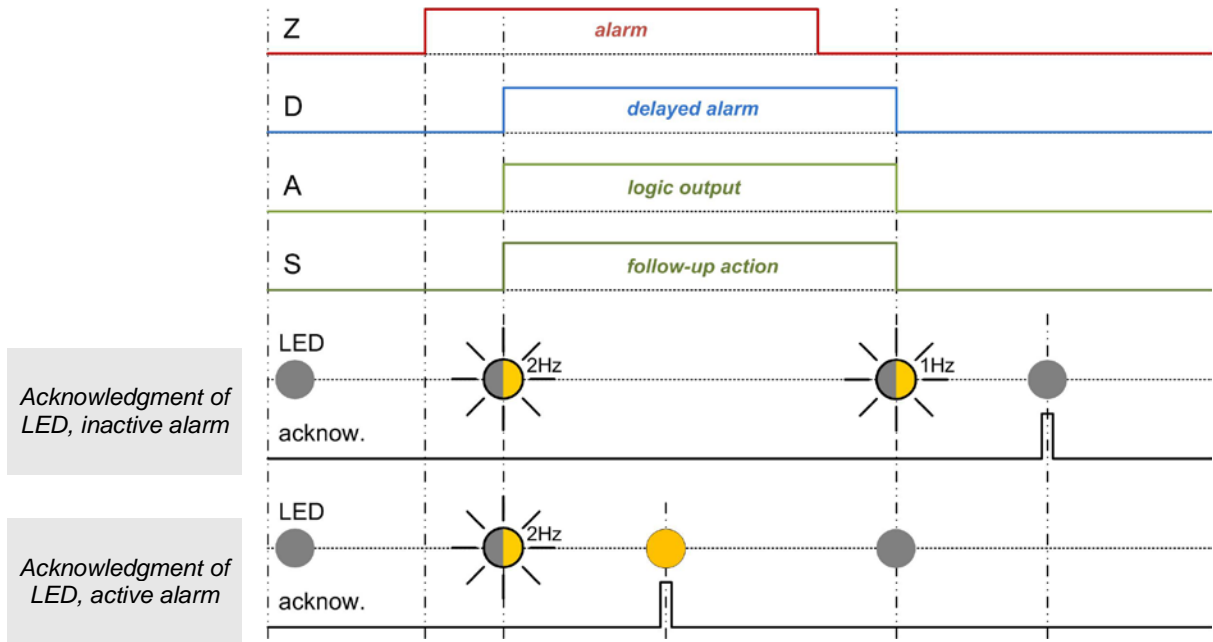

2) Alarm reset active, switch-in and dropout delay 0s, follow-up action inverted

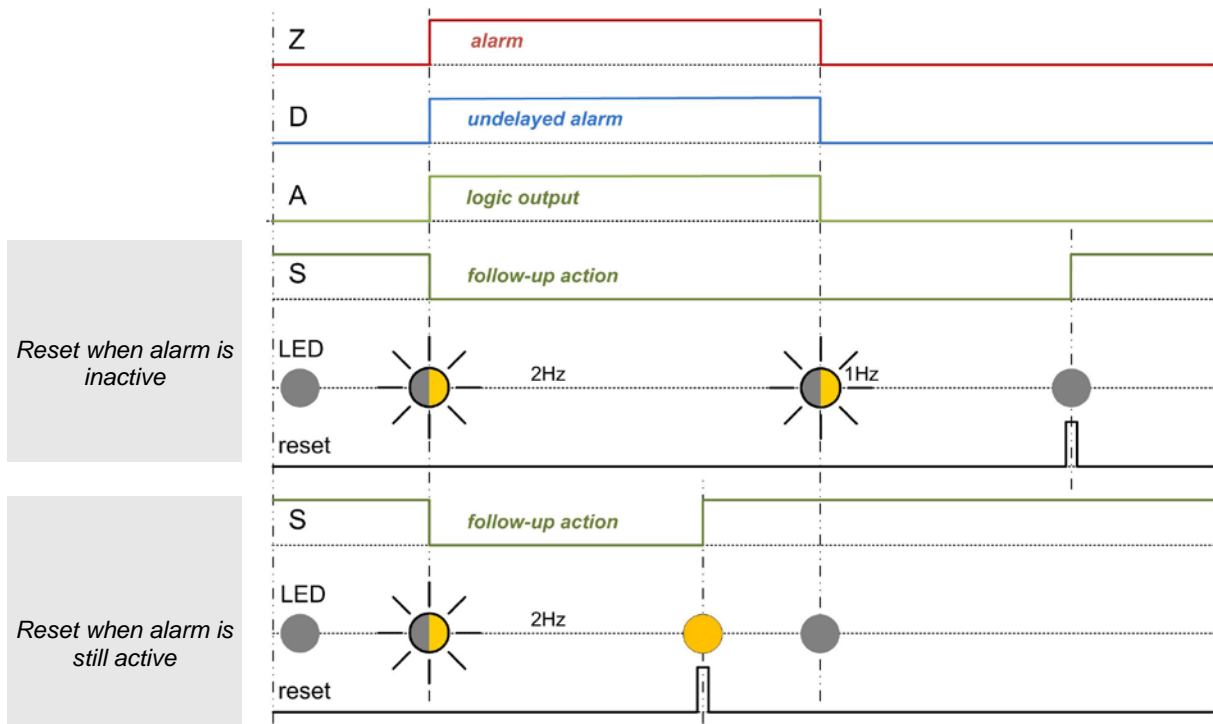

3.3.2 Logic components

The logic outputs are calculated via a two level logical combination of states, which are present at the inputs. Usable components are AND, OR and XOR gates as well as their inversions NAND, NOR and XNOR.

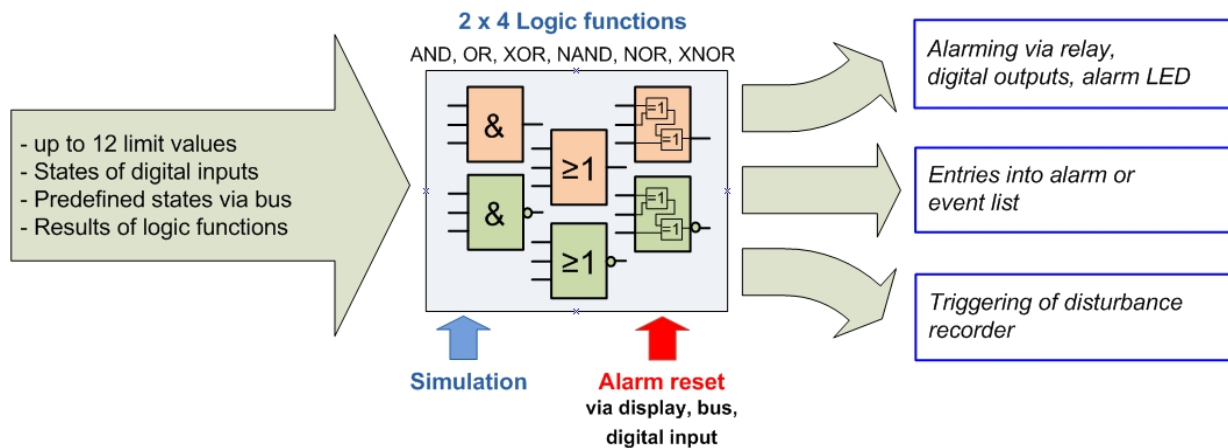

The principal function of the logical gates is given in the following table, for simplicity shown for gates with two inputs only.

function	symbol	older symbols		truth table	plain text
		ANSI 91-1984	DIN 40700 (alt)		
AND				A B Y	Function is true if all input conditions are fulfilled
				0 0 0	
				0 1 0	
				1 0 0	
				1 1 1	
NAND				A B Y	Function is true if at least one of the input conditions is not fulfilled
				0 0 1	
				0 1 1	
				1 0 1	
				1 1 0	
OR				A B Y	Function is true if at least one of the input conditions is fulfilled
				0 0 0	
				0 1 1	
				1 0 1	
				1 1 1	
NOR				A B Y	Function is true if none of the input conditions is fulfilled
				0 0 1	
				0 1 0	
				1 0 0	
				1 1 0	
XOR				A B Y	Function is true if exactly one of the input conditions is fulfilled
				0 0 0	
				0 1 1	
				1 0 1	
				1 1 0	
XNOR				A B Y	Function is true if all of the input conditions are fulfilled or all conditions are not fulfilled
				0 0 1	
				0 1 0	
				1 0 0	
				1 1 1	

The logic components of the first level may combine up to three, the components of the second level up to four input conditions. If individual inputs are not used, their state is automatically set to a condition which has no influence on the logic result.

3.3.3 Limit values

States of limit values are the most important input quantities of the logic module. Depending on the application, limits either monitor the exceeding of a given value (upper limit) or the fall below a given value (lower limit). Limits are defined by means of two parameters, the limit for the ON and the limit for the OFF state. The hysteresis is the difference between these two values.

Upper limit: The limit for ON state ($L.ON$) is higher than the limit for the OFF state ($L.OFF$)

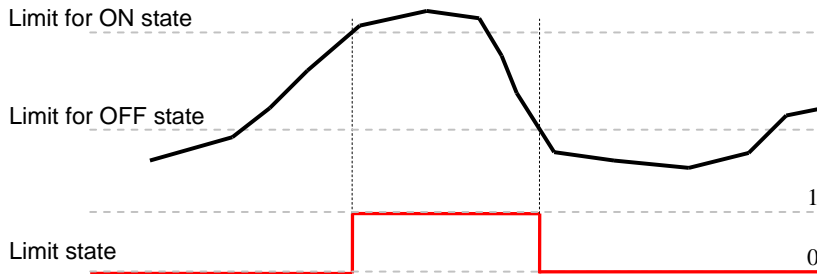

- ▶ The state 1 (true) results if the limit for ON state is exceeded. It remains until the value falls below the limit for OFF state again.
- ▶ The state 0 (false) results if the limit for ON state is not yet reached or if, following the activation of the limit value, the value falls below the limit for OFF state again.

Lower limit: The limit for ON state ($L.ON$) is smaller than the limit for OFF state ($L.OFF$)

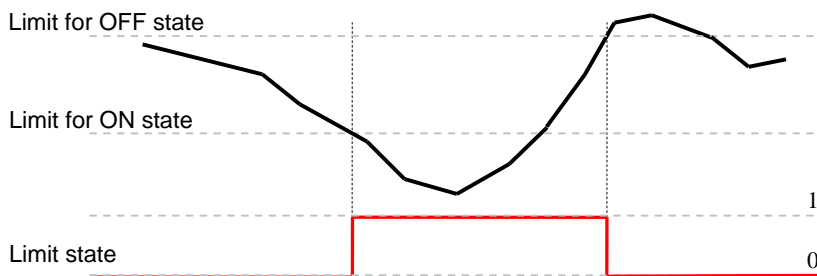

- ▶ The state 1 (true) results if the value falls below the limit for ON state. It remains until the value exceeds the limit for OFF state again.
- ▶ The state 0 (false) results if the value is higher than the limit for ON state or if, following the activation of the limit value, the value exceeds the limit for OFF state again.



If for a limit value the limit for ON state and the limit for OFF state are configured to the same value, it will be treated as an upper limit value with a hysteresis of 0%.

Limit values may be used to control the running of **operating hour counters**. As long as the limit values are fulfilled (logical 1) the operating hour counters keep on running. Not only operating times may be measured, but e.g. time under overload condition (additional stress) as well.

3.3.4 Sequence of evaluation

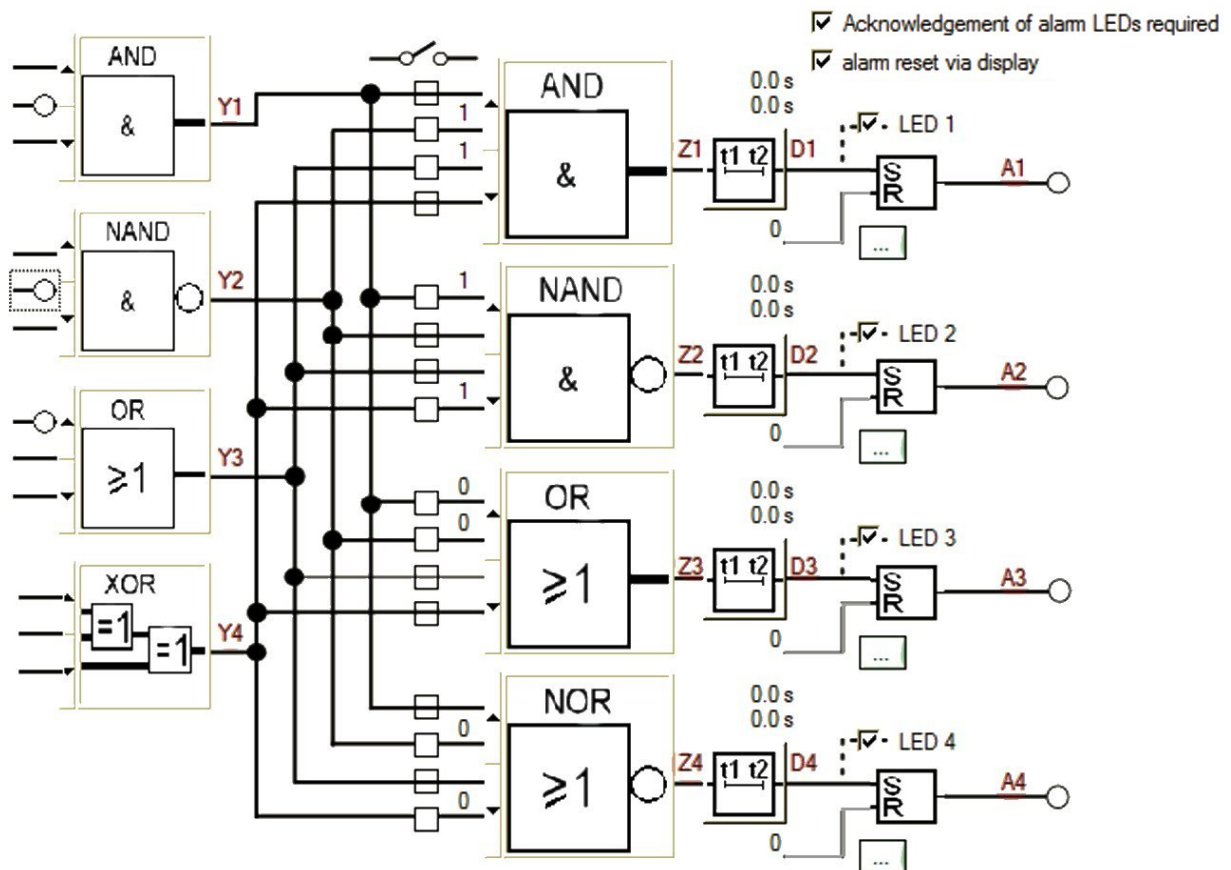

The evaluation of the logic module is performed from top to bottom and from left to right:

1. Y1, Y2, Y3, Y4
 2. Z1, Z2, Z3, Z4
 3. D1, D2, D3, D4
 4. A1, A2, A3, A4
- ▶ The evaluation is performed once each cycle of the power frequency, e.g. every 20ms at 50Hz. But the time between two evaluations will never be longer than 25ms.
 - ▶ If the logical states Y1...Y4, Z1...Z4, D1...D4 and A1...A4 are used as inputs, their changed states will be included in the evaluation of the next interval
 - ▶ Exception: In the first evaluation level the state of previous logical functions may be used as input without delay, e.g. the state Y1 for the logical functions with output Y2, Y3 or Y4.

3.4 Free Modbus image

Accessing measured data of a Modbus device often needs some special effort, if the interesting measurements are stored in different, non continuous register areas. This way multiple telegrams must be sent to the device to read all data. This needs time and it's very likely, that the measurements don't originate from the same measurement cycle.

A free assembly of the data to read helps a lot. The *APLUS* supports, along with the still available classical Modbus image with thousands of registers, the facility to assemble two different images, which may be read with one telegram only. These freely assembled images are refreshed after each measurement cycle and therefore always provide the most present values.

The free float image

Up to 60 instantaneous, mean, unbalance or THD/TDD values may be arranged in any sequence on the register addresses 41840-41958. All of these values are floating point numbers, which allocate 2 registers per value. Meter values are not possible because they have another format.

The free integer image

Some older control systems are not able to handle float values. To make it possible to work with the data of the device up to 20 16-Bit integer values can be derived from the existing measurement values. These values will then be stored in the free Modbus image (register 41800 up to 41819) as integer values with selectable range of values.

Example: Current transformer 100/5A, measurement current phase 1, over range 20%

- ▶ The reference value is 120A (maximum measurable current)
- ▶ The integer value shall be 12'000 if the measurement is 120A

After selecting the measured quantity and entering the register value of 12'000 automatically a scaling factor of 100.0 is calculated. The measurement I1 therefore will be multiplied by 100.0 before it is converted into an integer value and stored in the Modbus image.

Also in the integer image instantaneous, mean, unbalance or THD/TDD values may be arranged.



For devices with Profibus interface the Modbus image is used for the assembly of the cyclical telegram. Via Modbus the same image can be used, but it's not possible to use it independently.

The Modbus communication of the *APLUS* is described in a separate document. Depending on the communication hardware selected, either the manual for Modbus/RTU or Modbus/TCP protocol should be used.

- ▶ **W157 695: Modbus/RTU interface *APLUS* (communication interface RS485)**
- ▶ **W162 636: Modbus/TCP interface *APLUS* (communication interface Ethernet)**

4. Mechanical mounting

- ▶ The standard version of the *APLUS* is designed for panel mounting as shown below
- ▶ The version without display with top-hat rail adapter may be clipped onto a top-hat rail according to EN50022

	Please ensure that the operating temperature limits are not exceeded when determining the place of mounting (place of measurement): -10 ... 55°C
---	--

4.1 Panel cutout

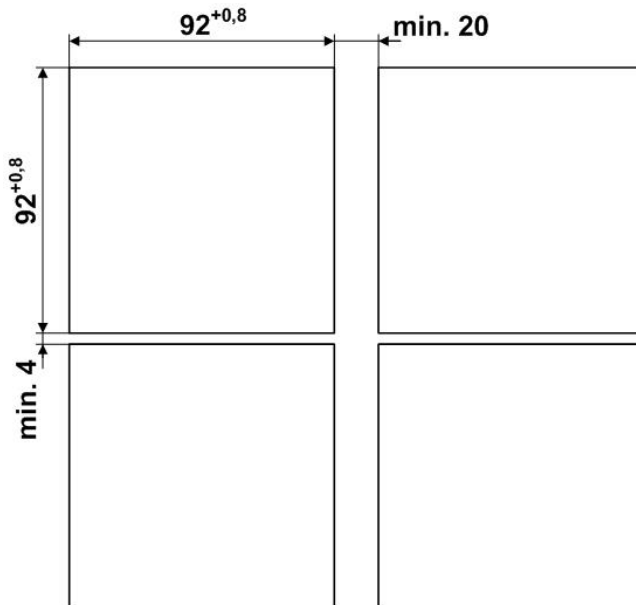

Dimensional drawing *APLUS*:
[See section 10](#)

4.2 Mounting of the device

The *APLUS* is suitable for panel widths up to 10mm.

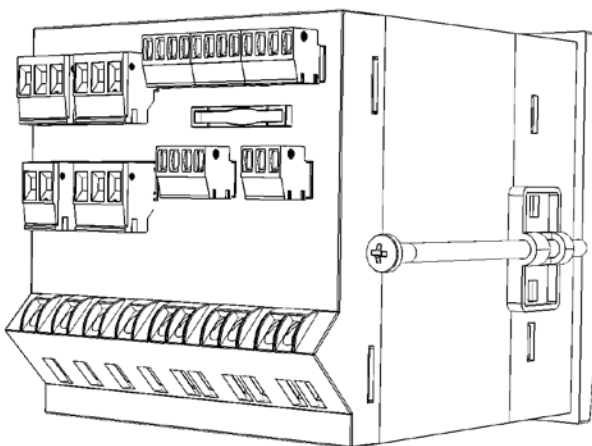

- Slide the device into the cutout from the outside
- From the side slide in the mounting clamps into the intended openings and pull them back about 2 mm
- Tighten the fixation screws until the device is tightly fixed with the panel

4.3 Demounting of the device

The demounting of the device may be performed only if all connected wires are out of service. Remove all plug-in terminals and all connections of the current and voltage inputs. Pay attention to the fact, that current transformers must be shortened before removing the current connections to the device. Then demount the device in the opposite order of mounting (4.2).

5. Electrical connections



Ensure under all circumstances that the leads are free of potential when connecting them !

5.1 General safety notes



Please observe that the data on the type plate must be adhered to !

The national provisions (e.g. in Germany VDE 0100 "Conditions concerning the erection of heavy current facilities with rated voltages below 1000 V") have to be observed in the installation and material selection of electric lines!

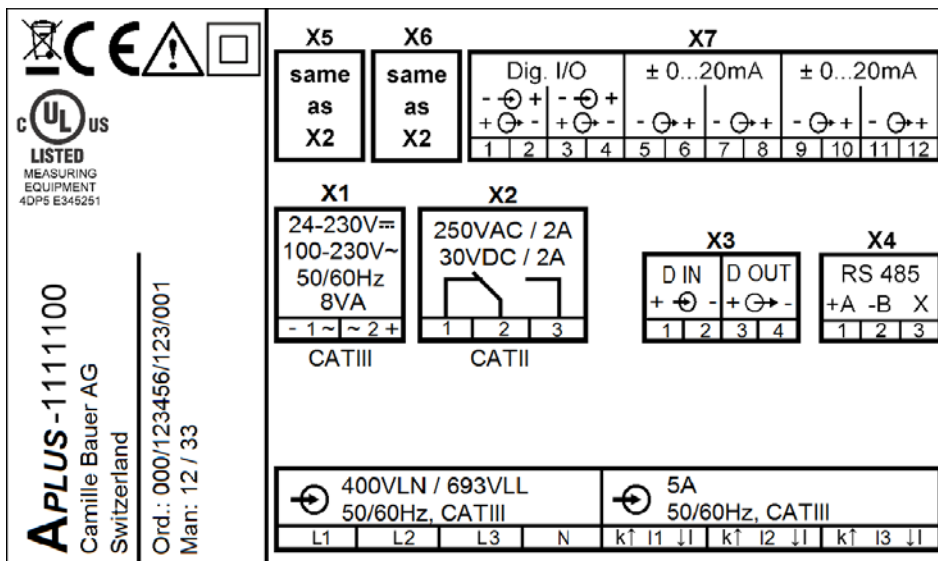

Nameplate of a device equipped with RS485 interface and I/O extension 1

Symbol	Meaning
	Device may only be disposed of in a professional manner!
	Double insulation, device of protection class 2
	CE conformity mark. The device fulfills the requirements of the applicable EU directives.
	Products with this mark comply with both the Canadian (CSA) and the American (UL) requirements.
	Caution! General hazard point. Read the operating instructions.
	General symbol: Input
	General symbol: Output
CAT III	Measurement category CAT III for current / voltage inputs and power supply
CAT II	Measurement category CAT II for relay outputs

5.2 Electrical connections of the I/Os

I/O no.	Terminal	No.	APLUS	I/O extension 1	I/O extension 2
1	X2	1, 2, 3	Relay		
2	X3	1, 2	Digital input		
3	X3	3, 4	Digital output		
4	X5	1, 2, 3		Relay	Relay
5	X6	1, 2, 3		Relay	Relay
6	X7	1, 2		Digital I/O	Digital I/O
7	X7	3, 4		Digital I/O	Digital I/O
8	X7	5, 6		Analog output $\pm 20\text{mA}$	Digital I/O
9	X7	7, 8		Analog output $\pm 20\text{mA}$	Digital I/O
10	X7	9, 10		Analog output $\pm 20\text{mA}$	Digital I/O
11	X7	11, 12		Analog output $\pm 20\text{mA}$	Digital I/O

I/O no. - as used in the CB-Manager software

5.3 Possible cross sections and tightening torques

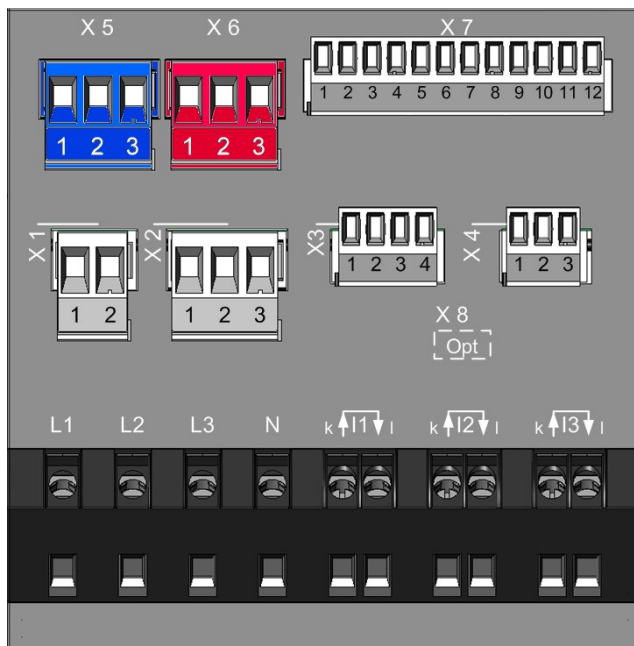

Inputs L1, L2, L3, N, I1 k-I, I2 k-I, I3 k-I

Single wire

1 x 0,5 ... 4,0mm² or 2 x 0,5 ... 2,5mm²

Multiwire with end splices

1 x 0,5 ... 2,5mm² or 2 x 0,5 ... 1,5mm²

Tightening torque

0,5...0,6Nm resp. 4,42...5,31 lbf in

Power supply X1, Relays X2, X5, X6

Single wire

1 x 0,5 ... 2,5mm² or 2 x 0,5 ... 1,0mm²

Multiwire with end splices

1 x 0,5 ... 2,5mm² or 2 x 0,5 ... 1,5mm²

Tightening torque

0,5...0,6Nm resp. 4,42...5,31 lbf in

I/O's X3, X7 and RS485 connector X4

Single wire

1 x 0,5 ... 1,5mm² or 2 x 0,25 ... 0,75mm²

Multiwire with end splices

1 x 0,5 ... 1,0mm² or 2 x 0,25 ... 0,5mm²

Tightening torque

0,2...0,25Nm resp. 1,77...2,21 lbf in

5.4 Inputs



All voltage measurement inputs must originate at circuit breakers or fuses rated 10 Amps or less. This does not apply to the neutral connector. You have to provide a method for manually removing power from the device, such as a clearly labeled circuit breaker or a fused disconnect switch.

When using **voltage transformers** you have to ensure that their secondary connections never will be short-circuited.



No fuse may be connected upstream of the **current measurement inputs** !

When using **current transformers** their secondary connectors must be short-circuited during installation and before removing the device. Never open the secondary circuit under load.

The connection of the inputs depends on the configured system (connection type). The required device external fusing of the voltage inputs is not shown in the following connection diagrams.

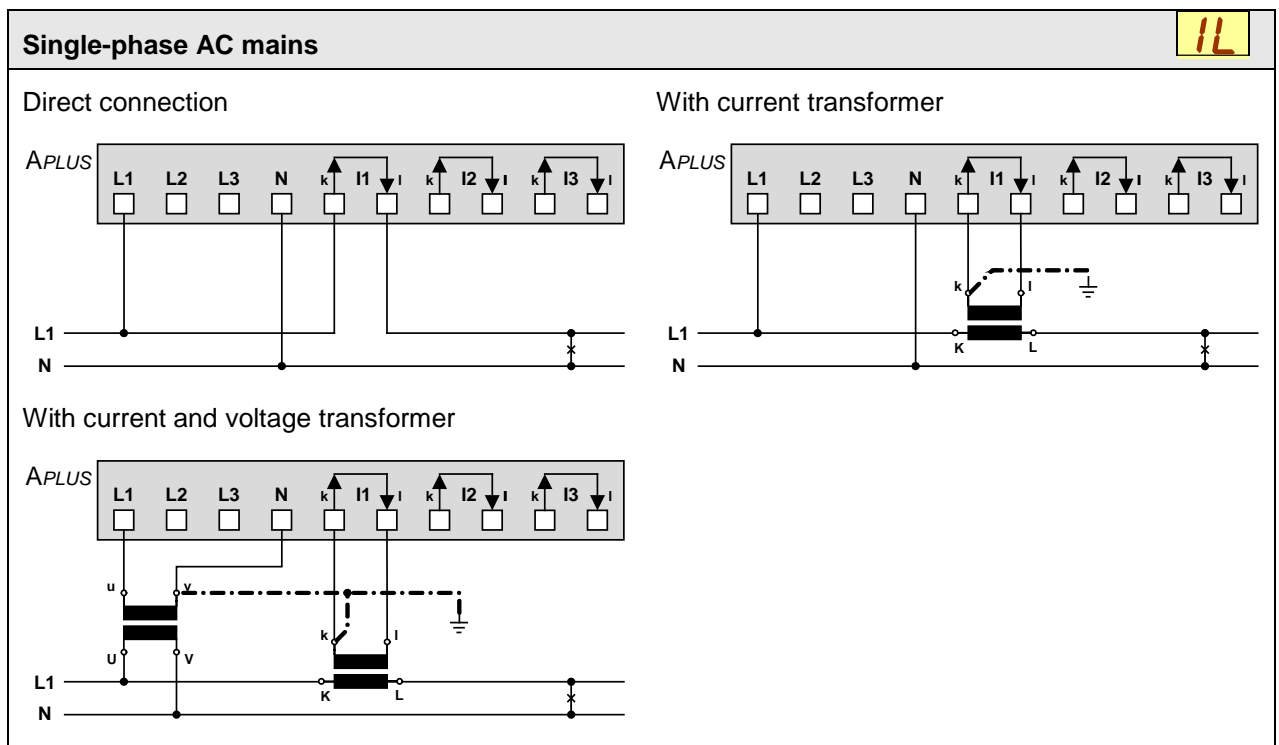

Three wire system, balanced load, current measurement via L1

3L.6

Direct connection

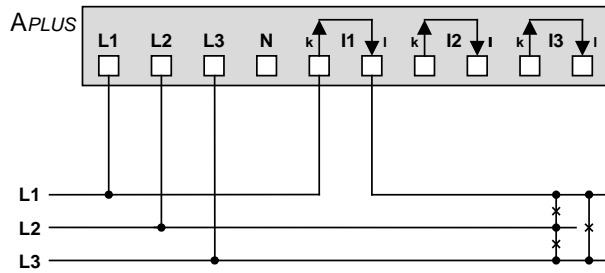

With current transformer

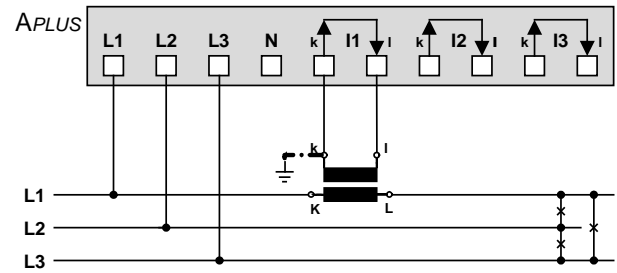

With current and voltage transformer

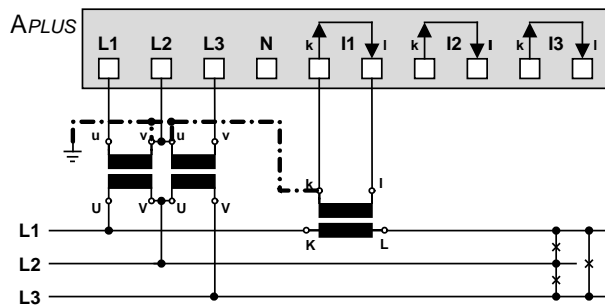

In case of current measurement via L2 or L3 connect voltages according to the following table:

Current	Terminals	L1	L2	L3
L2	I1-k I1-I	L2	L3	L1
L3	I1-k I1-I	L3	L1	L2

 By rotating the voltage connections the measurements U₁₂, U₂₃ and U₃₁ will be assigned interchanged!

Four wire system, balanced load, current measurement via L1

4L.6

Direct connection

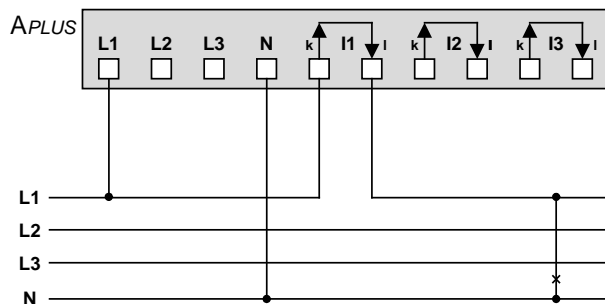

With current transformer

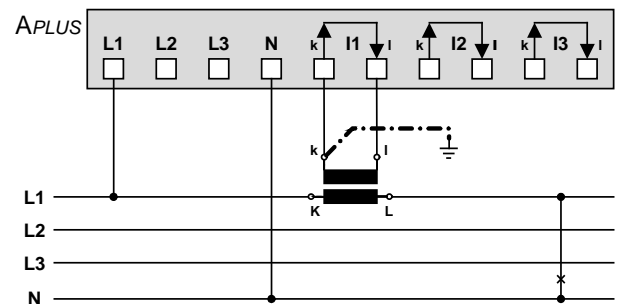

With current and voltage transformer

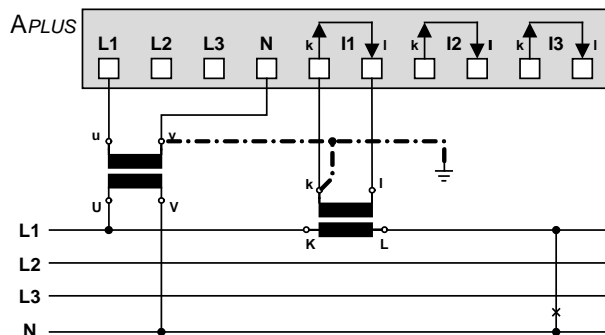

In case of current measurement via L2 or L3 connect voltages according to the following table:

Current	Terminals	L1	N
L2	I1-k I1-I	L2	N
L3	I1-k I1-I	L3	N

Three wire system, unbalanced load

3LUB

Direct connection

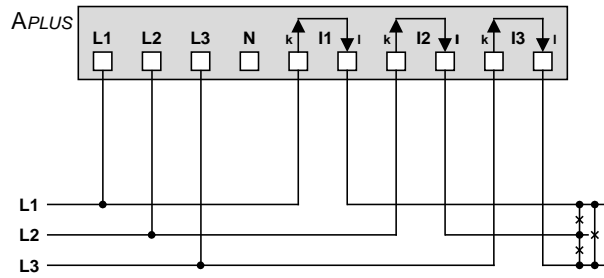

With current transformers

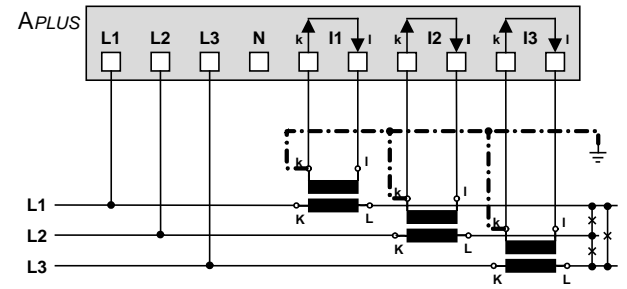

With current and 3 single-pole isolated voltage transformers

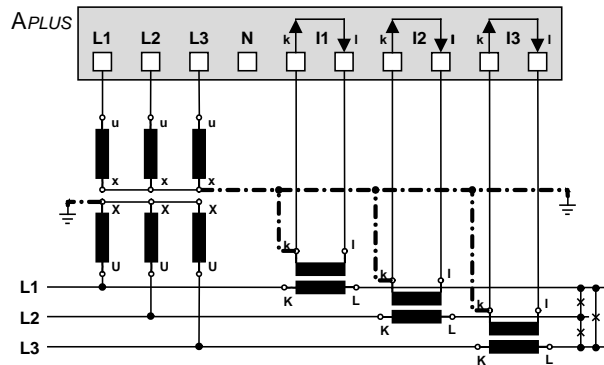

Three wire system, unbalanced load, Aron connection

3LUA

Direct connection

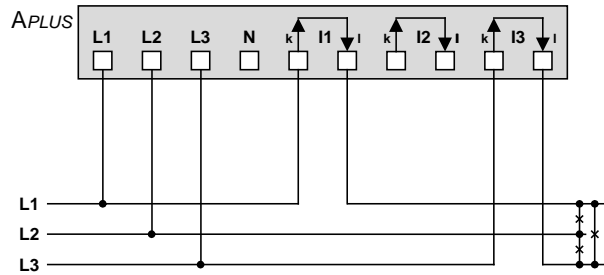

With current transformers

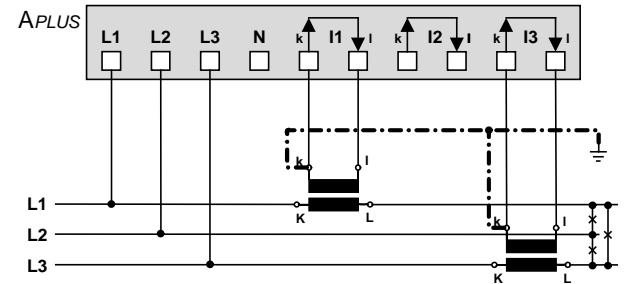

With current and 3 single-pole isolated voltage transformers

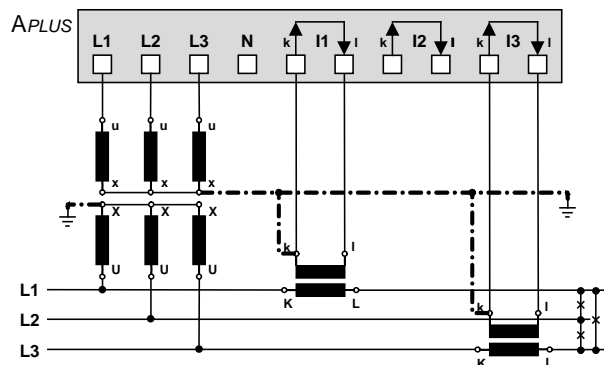

Four wire system, unbalanced load

4L.U6

Direct connection

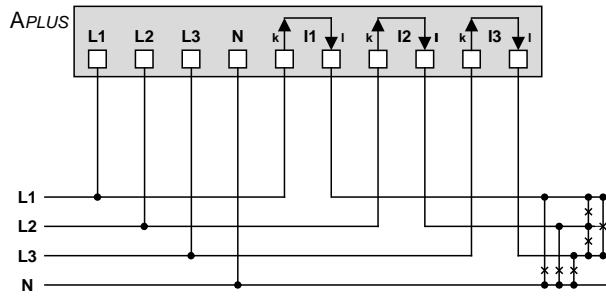

With current transformers

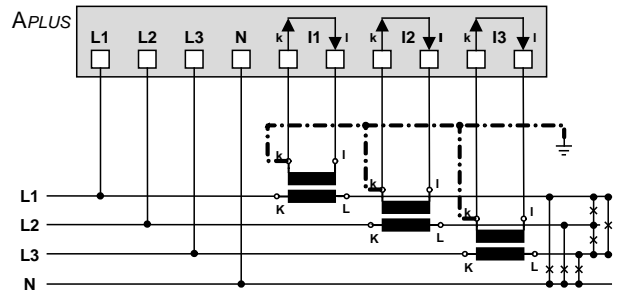

With current and 3 single-pole isolated voltage transformers

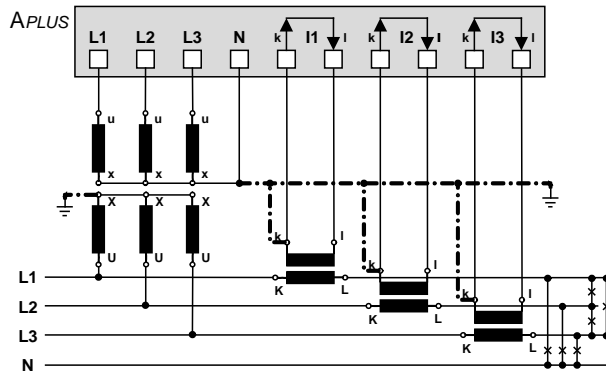

Four wire system, unbalanced load, Open-Y

4L.U4

Direct connection

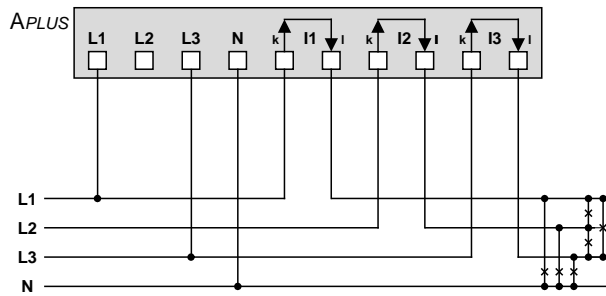

With current transformers

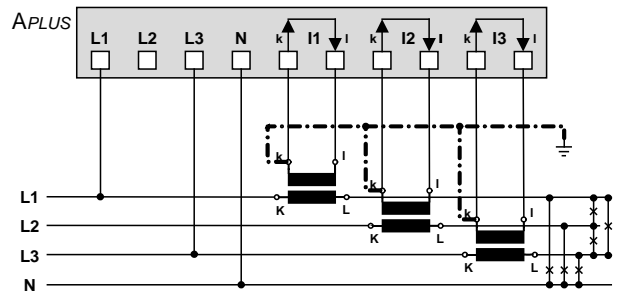

With current and 2 single-pole isolated voltage transformers

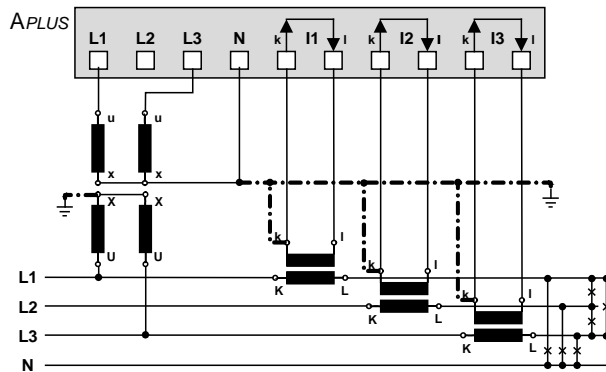

Direct connection

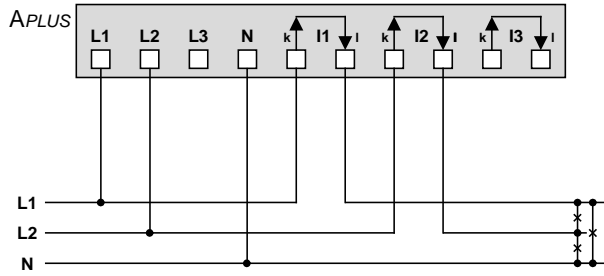

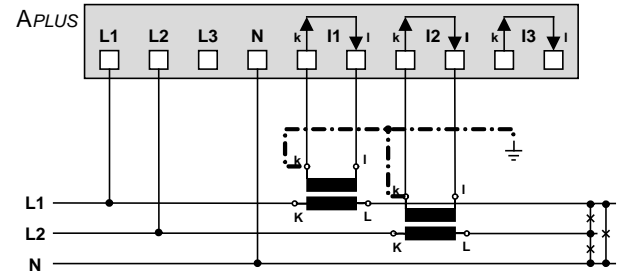

With current transformers

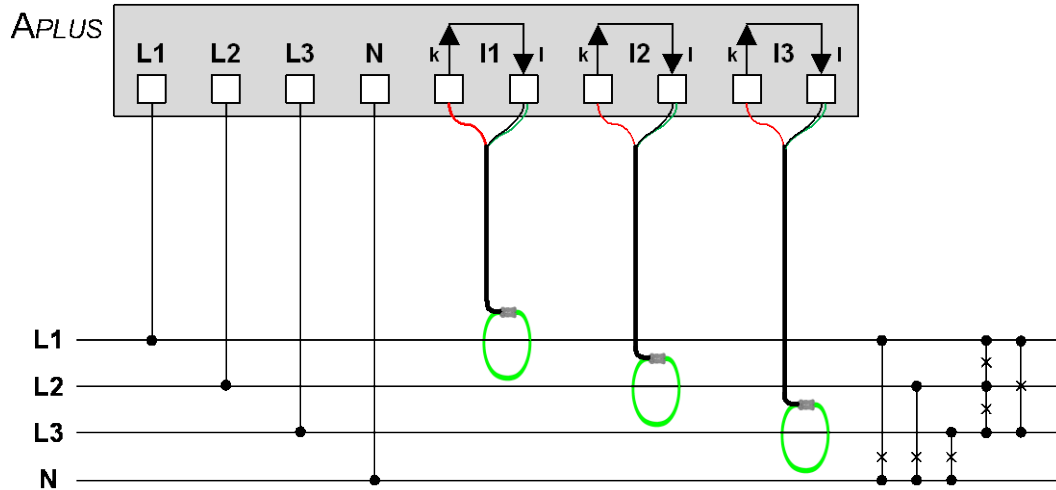

5.5 Rogowski current inputs

The connection of the Rogowski coils is performed depending on the selected system type, as shown in chapter 5.4 above. However, instead of current transformers a Rogowski coils is placed around each current-carrying conductor. This is subsequently shown for the measurement in a 4-wire low-voltage system.



 When connecting the coils you must follow the safety notices given in the operating instructions of the Rogowski coil. The current direction shown on the coils must match the real current direction and has to be the same for all phases.

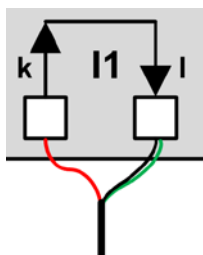
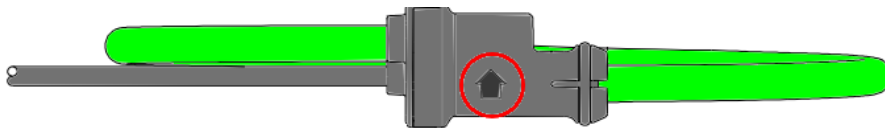

In order to suppress injected interferences the shielding (green) is connected always to the I terminal of the current inputs (I1-I, I2-I resp. I3-I).

5.6 Power supply



A marked and easily accessible current limiting switch has to be arranged in the vicinity of the device for turning off the power supply. Fusing should be 10 Amps or less and must be rated for the available voltage and fault current.

5.7 Relays



When the device is switched off the relay contacts are de-energized, but dangerous voltages may be present.

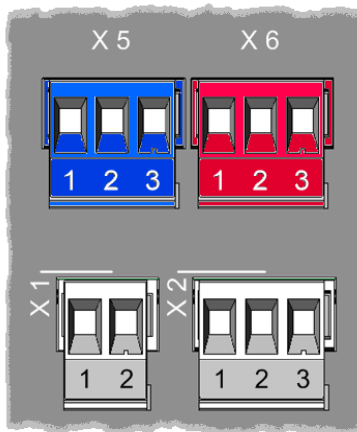

The relay X2 is part of the basic unit and therefore always available. The relays X5 and X6 are provided for device versions with I/O extension PCB only.

The plug-in terminals have different colours to prevent mixing up the connections. The pin assignment is the same for all relays:

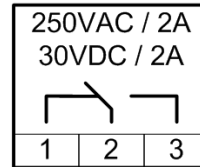

5.8 Digital inputs and outputs

For the digital inputs / outputs an external power supply of 12 / 24V DC is required.



The power supply shall not exceed 30V DC !

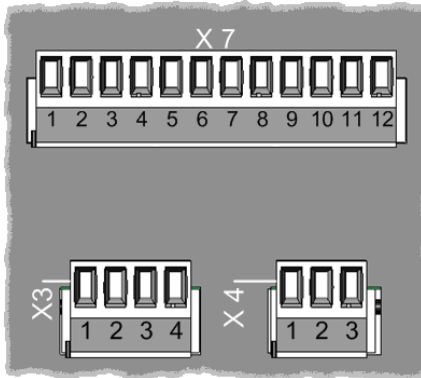

The plug-in terminal X7 is available for device versions with I/O extension PCB only.

The number of digital inputs / outputs varies depending on the optional built-in PCB, see nameplate. The operating direction of the digital I/Os on X7 may be individually selected by means of the PC software.



The assignment of the connections depends on whether an I/O is configured to be a digital input or a digital output.

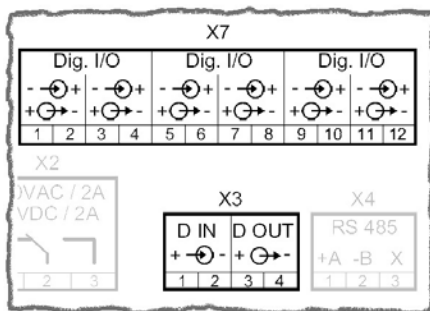

Example

Device with I/O extension 2 (2 relays + 6 digital I/Os)

The digital I/Os on **plug-in terminal X7** are individually programmable as input \rightarrow or output \leftarrow

On **plug-in terminal X3** a digital input and a digital output are provided statically. Their operating direction may not be modified.

Usage as digital input

- ▶ Meter tariff switching
- ▶ Operating feedback of loads for operating time counters
- ▶ Trigger and release signal for logic module
- ▶ Pulse input for meters of any kind of energy
- ▶ Clock synchronization
- ▶ Synchronization of billing intervals in accordance with energy provider

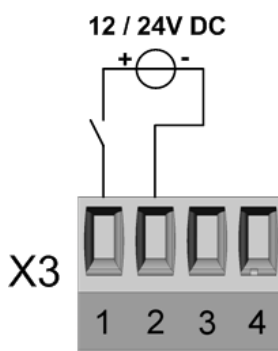

Technical data

Input current	< 7,0 mA
Counting frequency (S0)	≤ 16 Hz
Logical ZERO	- 3 up to + 5 V
Logical ONE	8 up to 30 V

Usage as digital output

- ▶ Alarm output for logic module
- ▶ State reporting
- ▶ Pulse output to an external counter (acc. EN62053-31)
- ▶ Remote controllable state output via bus interface

Driving a relay

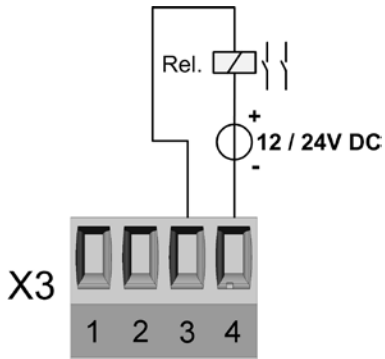

Technical data

Rated current	50 mA (60 mA max.)
Switching frequency (S0)	≤ 20 Hz
Leakage current	0,01 mA
Voltage drop	< 3 V
Load capacity	400 Ω ... 1 MΩ

Driving a counter mechanism

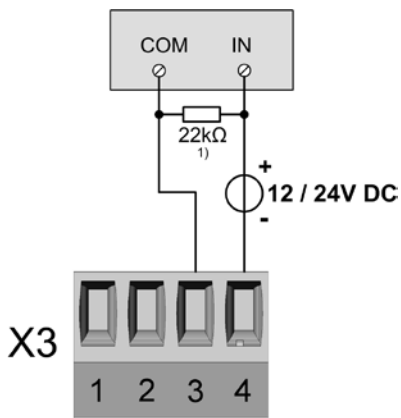

1) Recommended if input impedance of counter > 100 kΩ

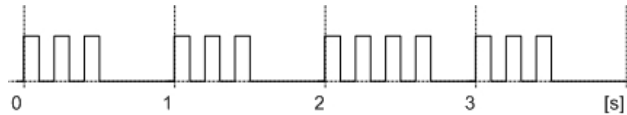

The width of the energy pulses can be selected by means of the PC software but have to be adapted to the counter mechanism. Once a second there is a decision how many pulses have to be output.

Therefore the delay between two pulses may not be used to determine the present power demand.

Electro mechanical meters typically need a pulse width of 50...100ms.

Electronic meters are partly capable to detect pulses in the kHz range. There are the types NPN (active negative edge) and PNP (active positive edge). For the *APLUS* a PNP type is required. The pulse width has to be at least 30ms (acc. EN62053-31). The delay between to pulses corresponds at least to the pulse width. The smaller the pulse width, the higher the sensitivity to disturbances.

5.9 Analog outputs

Analog outputs are available for devices with I/O extension 1 only. See nameplate.

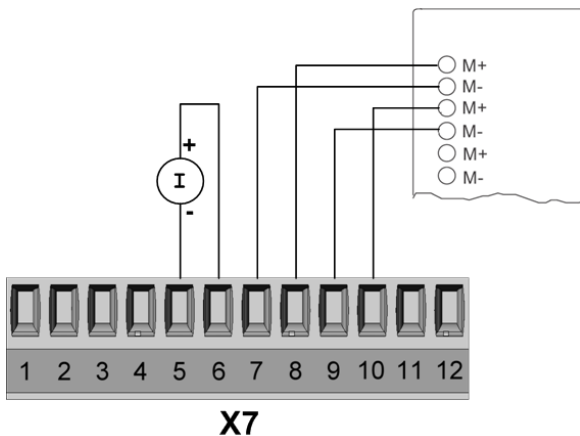

Connection to an analog input card of a PLC or a control system

The *APLUS* is an isolated measurement device. In addition the particular outputs are galvanically isolated. To reduce the influence of disturbances shielded twisted-pair cables should be used. The shield should be connected to earth on both opposite ends. If there are potential differences between the ends of the cable the shield should be earthed on one side only to prevent from equalizing currents.

Under all circumstances consider as well appropriate remarks in the instruction manual of the system to connect.

5.10 Modbus interface RS485 X4 and / or X8

Depending on the device version up to two Modbus interfaces are available on the plug-in positions X4 and / or X8. These are galvanically isolated. The connection terminals are distinguished by color: X4 (gray), X8 (black).

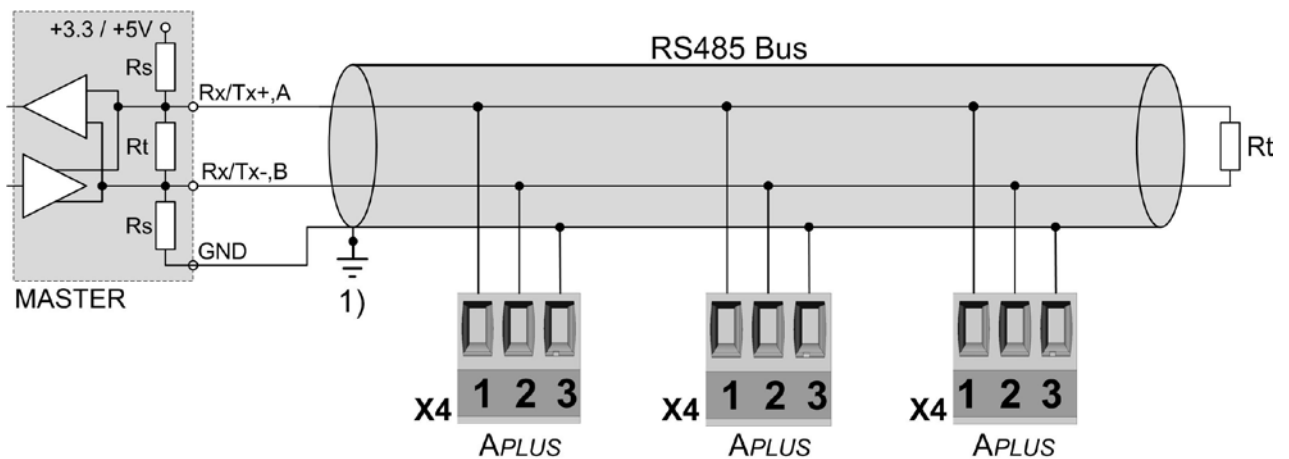

1) One ground connection only. This is possibly made within the master (PC).

Rt: Termination resistors: 120 Ω each for long cables (> approx. 10 m)

Rs: Bus supply resistors, 390 Ω each

The signal wires (X4-1, X4-2 resp. X8-1, X8-2) have to be twisted. GND (X4-3 resp. X8-3) can be connected via a wire or via the cable screen. In disturbed environments shielded cables must be used. Supply resistors (Rs) have to be present in bus master (PC) interface. Stubs should be avoided when connecting the devices. A pure daisy chain network is ideal.

You may connect up to 32 Modbus devices to each bus. A proper operation requires that all devices connected to the respective bus have equal communication settings (baud rate, transmission format) and unique Modbus addresses. If there are two Modbus interfaces, their settings may be different.

The bus system is operated half duplex and may be extended to a maximum length of 1200 m without repeater.

5.11 Profibus DP interface

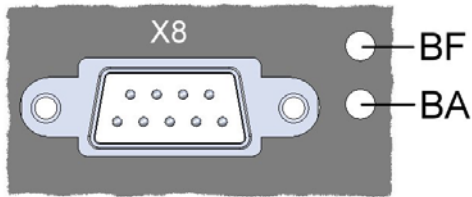

The 9-pin DSUB socket serves the connection of a standard Profibus plug. In a bus terminal device, the bus line must be terminated with resistors in the bus plug. Then standard pin assignment is as follows:

Pin	Name	Description
3	B	RxD/TxD-P
4	RTS	Request to send: CNTR-P (TTL)
5	GND	Data ground
6	+5V	VP
8	A	RxD/TxD-N

LED BF (Bus failure, yellow)

Status	Description
ON	Startup state or internal communication error
Flashing (2Hz)	Parameterization check failed
OFF	Cyclical operation; no error

LED BA (Bus alive, green)

Status	Description
OFF	Startup state; no Profibus communication
Flashing (2Hz)	Profibus detected; waiting for parameterization from master
ON	Parameterization ok; Profibus communication active

6. Commissioning



Before commissioning you have to check if the connection data of the transducer match the data of the plant (see nameplate).

If so, you can start to put the device into operation by switching on the power supply and the measurement inputs.

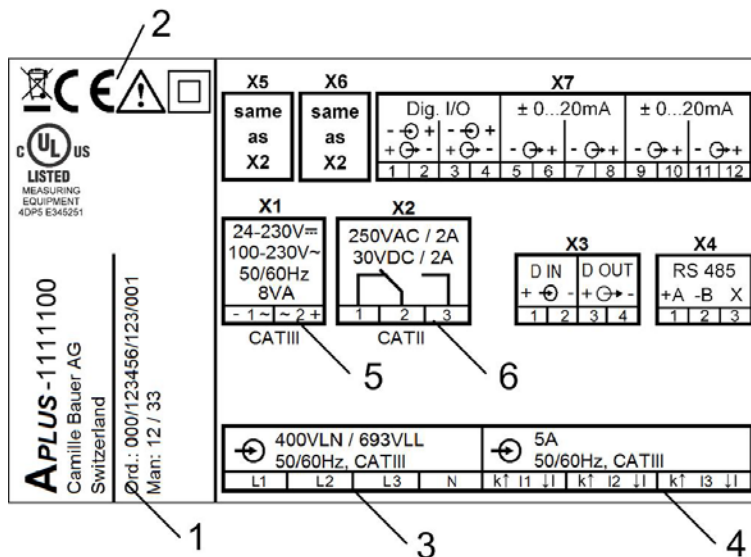

⊕ Measurement input

Input voltage
Input current
System frequency

- 1 Works no.
- 2 Test and conformity marks
- 3 Assignment voltage inputs
- 4 Assignment current inputs
- 5 Assignment power supply
- 6 Load capacity relay outputs

6.1 Software installation CB-Manager

A complete parametrization of the device is possible via configuration interface only, using the PC software CB-Manager.



The file "Read-me-first" provides all necessary information for the installation of the CB-Manager software and assistance for possible problems.

Functionality of the CB-Manager software

The software is primary a tool for the configuration of different devices (*APLUS*, CAM, VR660, A200R, V604s) and supports the user during commissioning and service. It allows as well the reading and visualization of measured data.

- ▶ Acquisition and modification of all device features
- ▶ Setting of real-time clock and time zone, selection of time synchronization method
- ▶ Archiving of configuration and measurement files
- ▶ Visualization of present measurements
- ▶ Reading, setting and resetting of meters
- ▶ Reading and resetting of minimum/maximum values
- ▶ Starting, stopping and resetting of the optional data logger
- ▶ Recording of measurement progressions during commissioning
- ▶ Check for correct device connection
- ▶ Simulation of states or outputs to test subsequent circuits
- ▶ Adjust the security system as protection against unauthorized access or manipulations

The CB-Manager software provides a comprehensive help facility, which describes in detail the operation of the software as well as all possible parameter settings.

6.2 Parametrization of the device functionality

Operating the software

The device configuration is divided into registers, which contain thematically the different function blocks of the device, e.g. "input", "limit values", "display". Thereby of course there are interdependencies, which have to be considered. If e.g. a current limit value is defined and subsequently the ratio of the current transformer is changed, there is a high probability that the limit value is changed as well. Therefore a meaningful sequence must be kept during setting the parameters. The easiest way is to handle register by register and line by line:

- ▶ **Device** (set the device version, if not read directly from the device)
 - If an I/O extension unit is used: Fix the data direction of the digital I/O's. Do to so just click on the appropriate entry and change the data direction in the I/O register. So it's assured that these I/O's can be used in the intended way. If e.g. you miss to change de basic setting "digital input" the appropriate channel can't be used as output in the logic module.*
- ▶ **Input**, especially system and transformer ratios
- ▶ **Mean values >> Limit values >> Logic module >> I/O 1-3**
- ▶ if present: **I/O 4,5 >> I/O 6,7 >> I/O 8,9 >> I/O 10,11**
- ▶ **Operating hours**
- ▶ if present: **Logger >> Interface (Ethernet, Profibus DP) >> Display**
- ▶ **Modbus-Image** (if you want to define your own Modbus image)
- ▶ **Time zone** (for automatical handling of daylight saving time)

I/O 8,9	I/O 10,11	Operating hours	Logger	Interface	Display	Modbus Image	Time zone
Device	Input	Mean values	Limit values	Logic module	I/O 1-3	I/O 4,5	I/O 6,7
device Aplus ID <input type="text" value="351010816"/>		description <input type="text" value="APLUS"/>					
TAG <input type="text" value="APLUS"/>							
firmware version		device type					
input	1.03.0053	<input type="checkbox"/> logger	Bus <input type="text" value="RS485 MODBUS/RTU"/>				
Analysis	1.20.1609	<input checked="" type="checkbox"/> display	NLB <input type="text" value="0"/>				
Bus	0.00.0000	<input type="checkbox"/> Rogowski	memory <input type="text" value="0.00"/> MBytes				
I/O's	0.00.0000						
display	1.27.0260						
MODBUS		I/O's <input type="text" value="2 Relais + 2 Digital I/O + 4 Analog Out"/>					
device address	<input type="text" value="1"/> <input type="text" value="1"/>	<input type="checkbox"/> Security system		<input checked="" type="radio"/> X4 <input type="radio"/> X8			
baudrate	<input type="text" value="19200"/> <input type="text" value="19200"/>			<input type="text" value="1"/> relay		<input type="text" value="4"/> relay	
parity	<input type="text" value="none"/> <input type="text" value="none"/>			<input type="text" value="2"/> digital input		<input type="text" value="5"/> relay	
data bits	<input type="text" value="8"/> <input type="text" value="8"/>			<input type="text" value="3"/> Digital output		<input type="text" value="6"/> digital input	
stopbits	<input type="text" value="2"/> <input type="text" value="2"/>			<input type="text" value="7"/> digital input		<input type="text" value="8"/> Analog output	
						<input type="text" value="9"/> Analog output	
						<input type="text" value="10"/> Analog output	
						<input type="text" value="11"/> Analog output	

ONLINE / OFFLINE

The parametrization may be performed ONLINE (with existing connection to the device) or OFFLINE (without connection to the device). To perform an ONLINE configuration first the configuration of the connected device, and therewith its hardware version, is read. A modified configuration can then be downloaded to the device and stored on the hard disk of the computer for archiving.

An OFFLINE parametrization can be used to prepare device configurations, to store them on disk and to download it to the devices, once you are in the field where the devices are installed. To make this work, the device versions selected during parametrization must agree with the versions on site.

6.3 Installation check

Check if inputs are connected correctly

- ▶ Voltage (at least 20% U_{rated}) and current (at least 2% I_{rated}) must be present

Using the connection check, which is integrated in the visualization of the instantaneous values, the correct connection of the current and voltage inputs may be checked. The phase sequence will be checked, as well as if there are open connections or reversed current connections (which change the direction of the current).

The image below shows open current connections (red description I1, I2, I3). This arises because the individual currents are below 2% of the rated value.

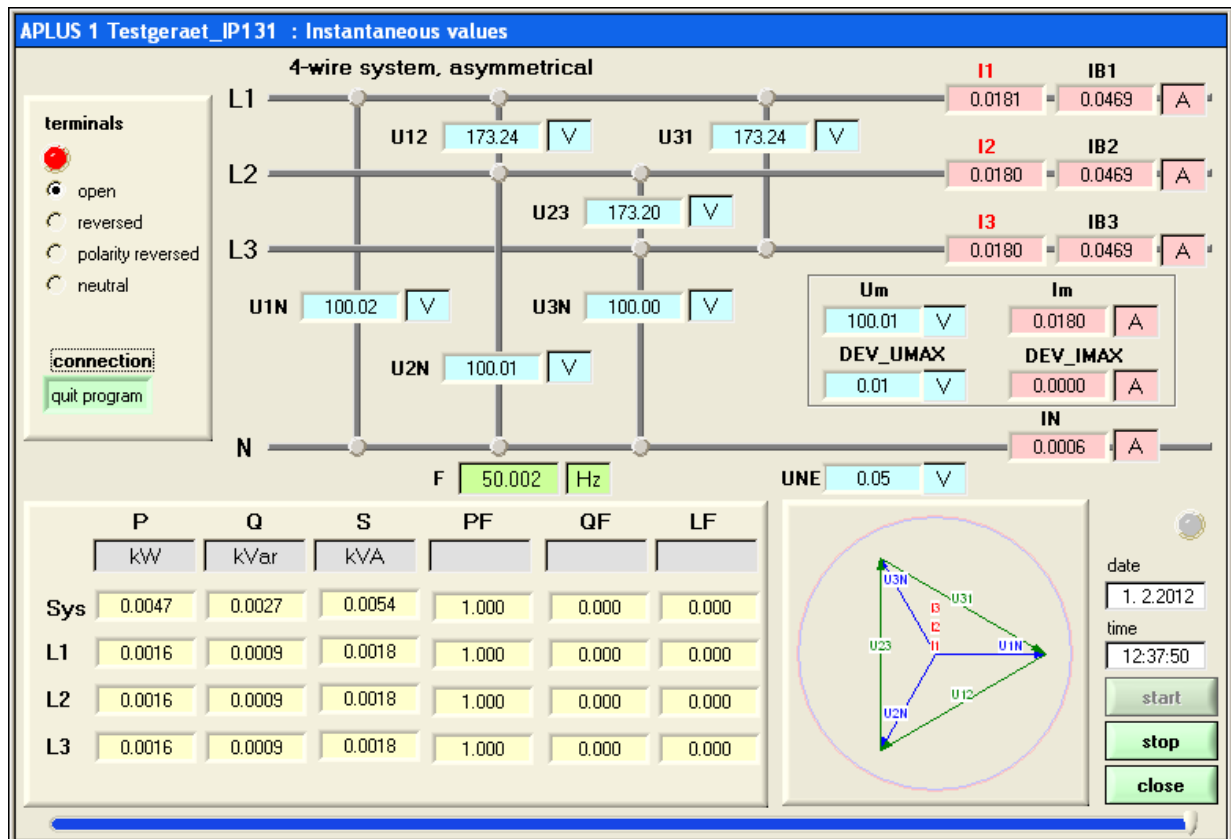

Simulation of I/O's

To check if subsequent circuits will work properly with the measurement data provided by the APLUS all analog, digital and relay outputs may be simulated, by predefining any output value resp. discrete state by means of the CB-Manager software.

Also all functions of the logic module, which allows performing any combination of logical states, may be predefined. This way e.g. an alarming due to a violation of a limit value can be simulated.

6.4 Installation of Ethernet devices

6.4.1 Connection

Before devices can be connected to an existing Ethernet network, you have to ensure that they will not disturb the normal network service. The rule is:



None of the devices to connect is allowed to have the same IP address than another device already installed

The factory setting of the IP address of *APLUS* is: 192.168.1.101

The standard RJ45 connector serves for direct connecting an Ethernet cable. If the PC is directly connected to the device a cross-wired cable must be used.

The network installation of the devices is done by means of the CB-Manager software (see [6.4.2](#)) or directly via the local programming on the display. As soon as all devices have a unique network address they may be accessed by means of a suitable Modbus master client.

- Interface: RJ45 connector, Ethernet 100BaseTX
- Mode: 10/100 MBit/s, full / half duplex, Auto-negotiation
- Protocols: Modbus/TCP, NTP

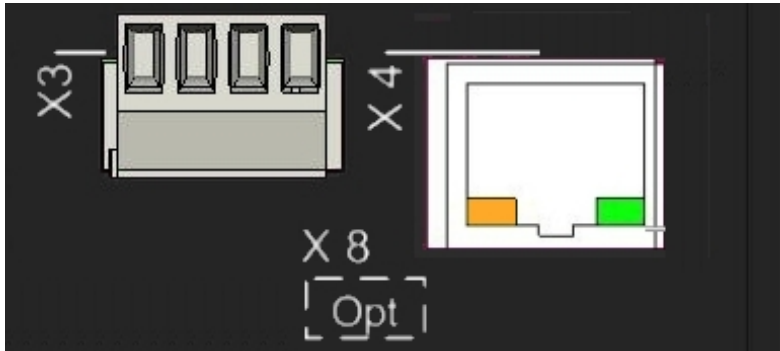

Function of the LED's

LED 1 (Green)	<ul style="list-style-type: none"> • ON as soon as a network connection exists • Flashing when data is transmitted via Ethernet connection
LED 2 (Orange)	<ul style="list-style-type: none"> • Flashing with 4 Hz during start-up • ON during Modbus/TCP communication with the device

APLUS-1111100
Camille Bauer AG
Switzerland

Mat.: 123456 / 1234567/ 001
Man.: 09/39
MAC: 00:12:34:AE:00:01

LISTED MEASURING EQUIPMENT 4DP5 E345251

To have a unique identification of Ethernet devices in a network, to each connection a unique MAC address is assigned. This address is given on the nameplate, in the example 00-12-34-AE-00-01.

Compared to the IP address, which may be modified by the user any time, the MAC address is statically.

6.4.2 Network installation using the CB-Manager software

For the subsequent Modbus/TCP communication a unique network address must be assigned to each of the devices. This can be done very easily, using the CB-Manager software to search for devices which have a MAC address 00-12-34-AE-xx-xx, which identifies the device as *APLUS* of Camille Bauer. Because this is performed by means of a UDP broadcast telegram, the devices are allowed to have the same network address at the beginning, e.g. "192.168.1.101" as factory default.

As soon as to all the devices network settings with unique IP address have been assigned, they may be accessed and read using the Modbus/TCP protocol.

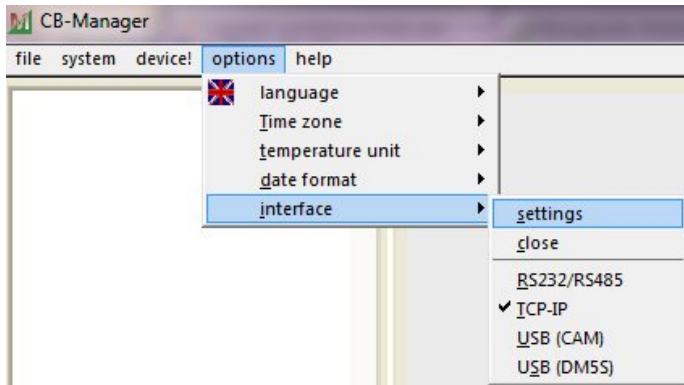

Select "settings" under options | interface. The interface type has to be set to "TCP-IP".

Devices in the local network

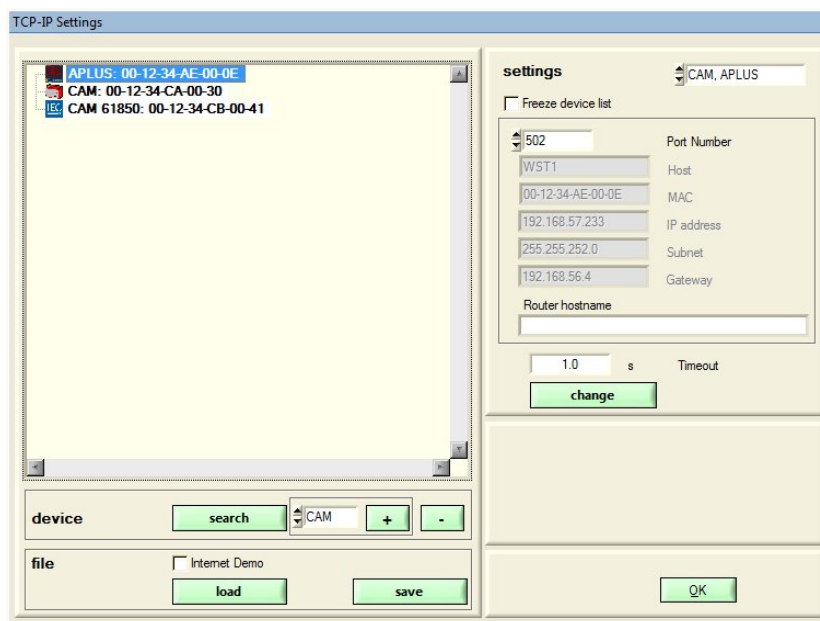

Set settings to "CAM, APLUS". Along with all *APLUS* also SINEAX CAM devices installed in the same network will be shown. The identification of the devices is possible by means of their MAC address, which is given on the nameplate (see [chapter 6.4.1](#)).

To assign a **unique** network address to a device, select it in the list and the click on "change".

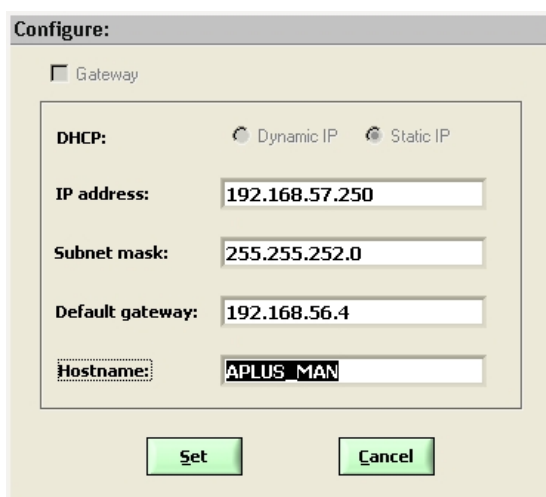

The following settings have to be arranged with the network administrator:

- **IP address:** This one must be **unique**, i.e. may be assigned in the network only once.
- **Subnet mask:** Defines how many devices are directly addressable in the network. This setting is equal for all the devices.
- **Default gateway:** Is used to resolve addresses during communication between different networks. Should contain a valid address within the own network.
- **Hostname:** Individual designation for each device. Helps to identify the device in the device list.

Example

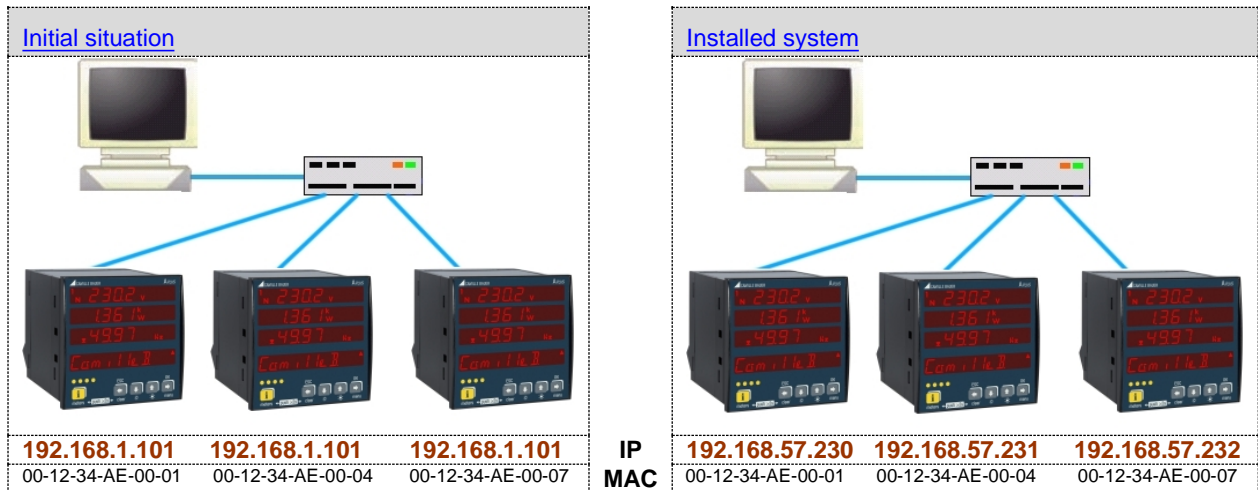

Devices outside the local network

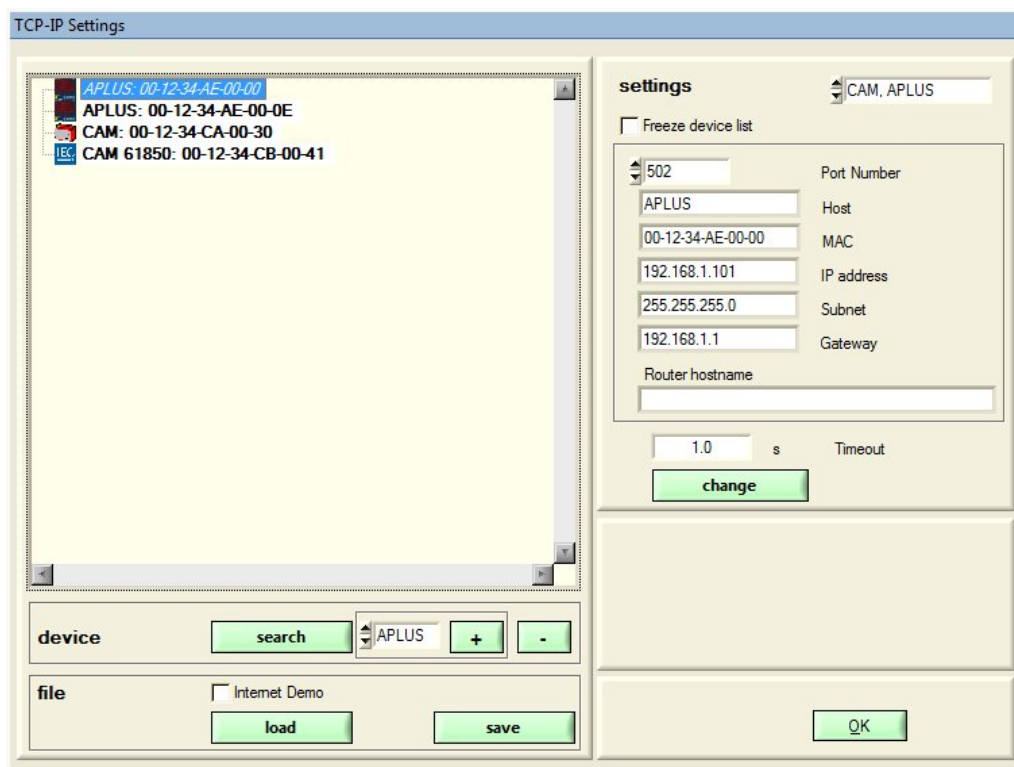

Devices which are not in the same network as the PC (e.g. in the Internet) can not be found and have to be added manually to the device list by means of **+**. The type of the device must be selected previously. To each entry you have to assign a unique IP and MAC address, which are different from the initial value. Otherwise it's not possible to add further entries.

The setting of the network parameters must be performed before mounting the device. As an alternative this may be done in the destination network via Ethernet interface.

6.4.3 Network installation by means of local programming

The network settings IP address, subnet mask and gateway can also be configured directly via the local programming of the *APLUS* on site.

This facility is shown in chapter [7.8](#)

6.4.4 Time synchronization via NTP-protocol

For the *time synchronization* via Ethernet *NTP* (Network Time Protocol) is the standard. Corresponding time servers are used in computer networks, but are also available for free via Internet. Using NTP it's possible to hold all devices on a common time base.

Two different NTP servers may be defined. If the first server is not available the second server is used for trying to synchronize the time. Adjusting of the clock is performed in the interval selected (15min. up to 24h). If no time synchronization is desired, to both NTP servers the address 0.0.0.0 have to be assigned.

The setting of the addresses is done by means of the CB-Manager software. The NTP data is arranged in the register "Ethernet" of the device configuration.

Activation

To activate the time synchronization via NTP, the "Synchronisation RTC" must be checked by means of the checkbox.

Gerät	Eingang	Mittelwerte	Grenzwert	Logikmodul	I/O 1-3	I/O 4-7
I/O 8,9	I/O 10,11	Betriebsstunden	Logger	Störschreiber	Ethernet	Anzeige

Einstellungen

IP Adresse	<input type="text" value="192.168.57.251"/>
Subnet-Maske	<input type="text" value="255.255.252.0"/>
Gateway	<input type="text" value="192.168.56.4"/>
NTP Server 1	<input type="text" value="192.168.56.56"/>
NTP Server 2	<input type="text" value="0.0.0.0"/>
Synchronisation RTC	<input checked="" type="checkbox"/> NTP Server
MODBUS TCP Port	<input type="text" value="502"/>
MAC Adresse	<input type="text" value="00 12 34 AE 00 07"/>

6.4.5 TCP ports for data transmission

TCP ports

The TCP communication is done via so-called ports. The number of the used port allows determining the type of communication. As a standard Modbus/TCP communication is performed via TCP port 502, NTP uses port 123. However, the port for the Modbus/TCP telegrams may be modified. You may provide a unique port to each of the devices, e.g. 503, 504, 505 etc., for an easier analysis of the telegram traffic. The setting of the Modbus TCP port is done as shown above. Independent of these setting a communication via port 502 is always supported. The device allows at least 5 connections to different clients at the same time.

Firewall

Due to security reasons nowadays each network is protected by means of a firewall. When configuring the firewall you have to decide which communication is desired and which have to be blocked. The TCP port 502 for the Modbus/TCP communication normally is considered to be unsafe and is very often disabled. This may lead to a situation where no communication between networks (e.g. via Internet) is possible.

6.5 Installation of Profibus DP devices

The Profibus DP interface allows data exchange with a control system via Profibus-DP V0. The modular device model provides maximum protocol efficiency.

Required measured variables are determined during engineering and arranged as a fixed process image. The control system does not require any intelligence for the evaluation of the data (no tunneling protocol).

Bus parameterising facilitates simple and fast commissioning. On-site the parameters in accordance with the [configuration menu](#) can be set, especially:

- Device address
- Accepting master parameterization (Check_User_Prm)
- Establishing communication to the master (Go_Online)
- Setting device address via master (Set_Slave_Addr_Supp)



For the assembly of the cyclical Profibus telegram the Modbus image is used. Via Modbus the same image can be used, but it's no longer possible to use it independently.

GSD parameterization

Typically the parameterization of the Profibus slave is done on the control system. During startup the *APLUS* adopts these settings. Doing so the parameterization of the input parameters (input system, transformer ratios etc.) as well as the assembly of the Modbus image will be overwritten. Other parts of the configuration, such as parameterization of I/O's or settings of limit values, remain unchanged.

All necessary informations for the parameterization are part of the DMF (GSD) file. T

The assumption of the engineered parameters can be prevented by deactivating the Check_User_Prm flag. The parameterization locally set will not be changed this way.

Cyclical data exchange

The user can compose its own „station“ with all required quantities. Up to 60 measured quantities can be modularly concatenated. You may choose from instantaneous values of the system and imbalance analysis, mean-values of power quantities and freely selectable quantities as well as meter values.

Subsequent to the adoption of the parameterization, the *APLUS* is ready for the cyclical data exchange with the control system.

6.6 Protection against device data changing

Data stored in the device may be modified or reset via communication interface or via the keys on the device itself. To restrict these possibilities on-site, via CB-Manager the security system in the device can be activated (factory default: not activated). For the definition of these user rights in the software the input of an administrator login is required. The factory default is:

user: admin
password: admin

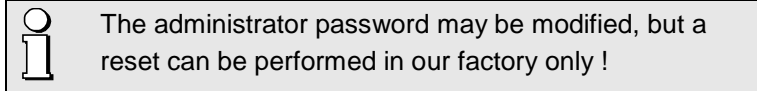

For one user via device and one user via interface (special login) the access to the following functions can individually be granted: Configuration of the device, modification of RTC parameters, modification of limit values, reset of min/max or meter values, alarm acknowledgment, display mode changing.

7. Operating the device

7.1 Display and operating elements

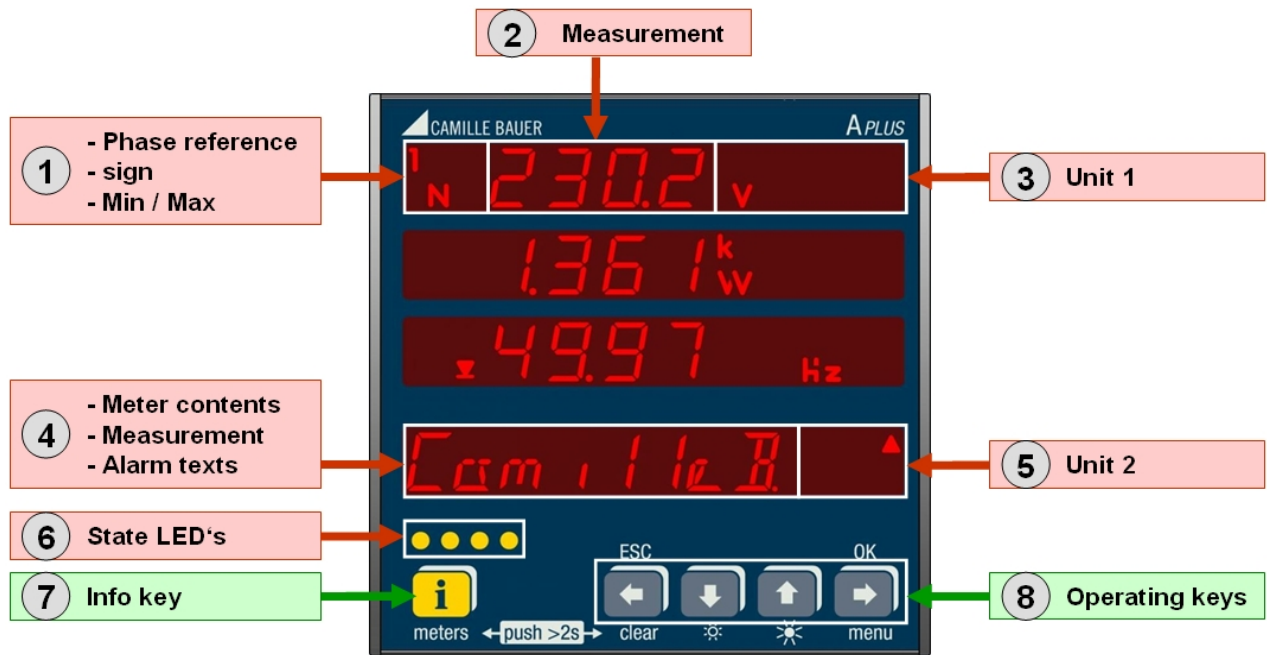

①	U_{1N} $3N$	Phase reference of measurement, sign of measurement, minimum or maximum value, e.g. U_{1N} (maximum value)
②	230.4 oL	4-digit display of measurements. On each change of the measurement display the short form of the quantities to display is shown first. If a measurement is out of the measurable range the string "oL" is shown instead of a measured value.
③	$kMGS\% \phi$ $WArHzkk$	Unit, measuring procedure, measurement type e.g. kVAr (reactive power)
④	POWER FA	8-digit meter display, 4-digit measurement display (P,Q,S,U,I) or 20-digit Alarm text display (e.g. " POWER FAILURE L1 ")
⑤	$kMGS \blacktriangle$ $Wh.rh \blacktriangledown$	Unit for meter quantities, high or low tariff, e.g. MWh high tariff Unit for the quantities P_x, Q_x, S_x, U_x, I_x
⑥		State display of alarms, e.g. Alarm 1 active
⑦	short >2s	Display of alarm state texts Reading of meter contents
⑧		Functionality depends on operating time, either 'short' or > 2s. To be used for measurement selection, brightness adjustment, navigation in menus, reset operations.

7.2 Operating modes

The device supports, along with the [configuration mode](#), three different operating modes. Normally the device is in the measurement display mode, but may be temporarily switched for the reading of the meters or for the display of alarm texts.

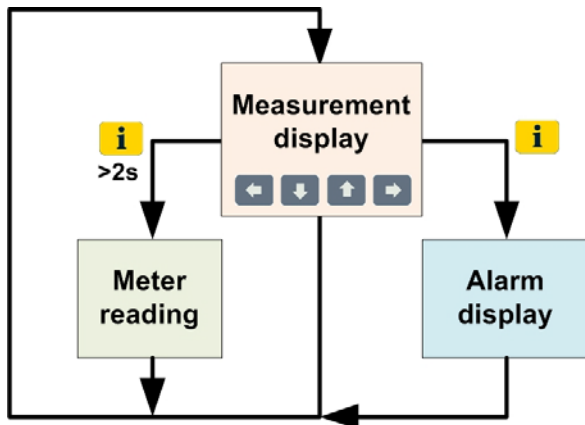

Measurement display: Is the normal operating mode of the device. By means of the navigation keys different measurement display can be selected. Depending on the selected display mode and the system monitored different measurement displays are available.

► [Available display modes](#)



Meter reading: By pressing the key **i** for a longer time an operating mode is started, which allows to read all the meter contents via line 4. This mode is automatically stopped after 30s without any key pressed or via the key **ESC**. If this mode is active no measurement info is displayed on line 1 to 3.

► [Meter reading](#)



Alarm display: By shortly pressing the key **i** an operating mode is started, which allows to display alarm state texts and to acknowledge alarms via line 4. If there are no configured alarms the message "No LED used" is displayed and then the mode is stopped. Otherwise the mode is automatically stopped after 30s without any key pressed or via the key **ESC**. If this mode is active no measurement info is displayed on line 1 to 3.

► [Monitoring and alarming](#)

► [Alarm handling](#)

7.3 Setting the display brightness

The brightness of the display can be set to one of thirteen levels.

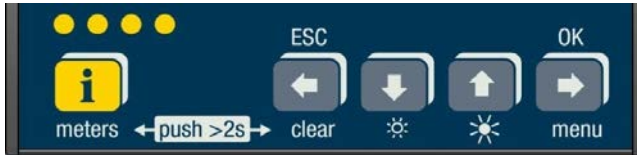

Brighter: Press key  longer than 2s; brightness will increase in steps

Darker: Press key  longer than 2s; brightness will decrease in steps





7.4 Display modes

The device supports four different display modes. They differ in the way measurement data is presented and which measurement data is provided.

- The selection of the display mode is described under [Configuration](#)

FULL mode

The measurement images of all displayable data are arranged in a matrix form. The selection is performed by means of the arrow keys:

	One image to the left. If first: most right image is displayed
	Most left image of the next line is displayed. If last: First line.
	Most left image of the previous line is displayed. If first: Last line.
	One image to the right. If last: most left image is displayed

The fourth line of each image is allocated to a programmable meter value (METER), which does not change even if another measurement image is selected.

- The complete display matrices are shown in [Annex B](#)





U12 U23 U31 METER	U12_MAX U23_MAX U31_MAX METER	U12_MIN U23_MIUN U31_MIN METER	DEV_UMAX DEV_UMAX_MAX METER	
UR1 UR2 U0 METER	UNB_UR2_UR1 UNB_UR2_UR1_MAX METER			
I1 I2 I3 METER	I1_MAX I2_MAX I3_MAX METER	IB1 IB2 IB3 METER	IB1_MAX IB2_MAX IB3_MAX METER	DEV_IMAX DEV_IMAX_MAX METER
IR1 IR2 I0 METER	UNB_IR2_IR1 UNB_IR2_IR1_MAX METER			
P P_MAX METER				
Q Q_MAX METER				
S S_MAX METER				
PF PF_MIN_IN_L PF_MIN_IN_C METER	PF PF_MIN_OUT_L PF_MIN_OUT_C METER	PFG PFG_MIN_IN_L PFG_MIN_IN_C METER	PFG PFG_MIN_OUT_L PFG_MIN_OUT_C METER	
F_MAX F F_MIN METER				
P Q S METER	U_MEAN I_MEAN P METER	P Q METER	S F METER	
D D_MAX METER	QG QG_MAX METER			
dd.mm hh.mm ss METER	OPR_CNTR1 OPR_CNTR2 OPR_CNTR3 METER	OPR_CNTR METER		
THD_U12 THD_U12_MAX METER	THD_U23 THD_U23_MAX METER	THD_U31 THD_U31_MAX METER		
TDD_I1 TDD_I1_MAX METER	TDD_I2 TDD_I2_MAX METER	TDD_I3 TDD_I3_MAX METER		

Example for 3-wire system, unbalanced load (harmonics and power mean-values not shown)

REDUCED mode

This display mode is a reduced version of the FULL mode. Some of the images or complete lines, e.g. the grayed data in the below example, can be hidden. So the display may be adapted easily to the information requirements on-site.

The selection of the measurement images is done via the arrow keys:



	One image to the left. If first: most right image is displayed
	Most left image of the next line is displayed. If last: First line.
	Most left image of the previous line is displayed. If first: Last line.
	One image to the right. If last: most left image is displayed



The fourth line of each image is allocated to a programmable meter value (METER), which does not change even if another measurement image is selected.

U12 U23 U31 METER	U12_MAX U23_MAX U31_MAX METER	U12_MIN U23_MIUN U31_MIN METER	DEV_UMAX DEV_UMAX_MAX METER	
UR1 UR2 U0 METER	UNB_UR2_UR1 UNB_UR2_UR1_MAX METER			
I1 I2 I3 METER	I1_MAX I2_MAX I3_MAX METER	IB1 IB2 IB3 METER	IB1_MAX IB2_MAX IB3_MAX METER	DEV_IMAX DEV_IMAX_MAX METER
IR1 IR2 I0 METER	UNB_IR2_IR1 UNB_IR2_IR1_MAX METER			
P P_MAX METER				
Q Q_MAX METER				
S S_MAX METER				
PF PF_MIN_IN_L PF_MIN_IN_C METER	PF PF_MIN_OUT_L PF_MIN_OUT_C METER	PFG PFG_MIN_IN_L PFG_MIN_IN_C METER	PFG PFG_MIN_OUT_L PFG_MIN_OUT_C METER	
F_MAX F F_MIN METER				
P Q S METER	U_MEAN L_MEAN P METER	PF P Q METER	S F METER	
D D_MAX METER	QG QG_MAX METER			
dd.mm hh.mm ss METER	OPR_CNTR1 OPR_CNTR2 OPR_CNTR3 METER	OPR_CNTR METER		
THD_U12 THD_U12_MAX METER	THD_U23 THD_U23_MAX METER	THD_U31 THD_U31_MAX METER		
TDD_I1 TDD_I1_MAX METER	TDD_I2 TDD_I2_MAX METER	TDD_I3 TDD_I3_MAX METER		



Example for 3-wire system, unbalanced load (harmonics and power mean-values not shown)

USER mode

This display mode allows a free assembly of up to 20 measurement images. Also the fourth line may be different for each image. Any meter value or another quantity (Ux, Ix, Px, Qx, Sx) may be assigned. The images are arranged among each other and selectable via the keys  and  :

	Image of the next line is displayed. If last: First line.
	Image of the previous line is displayed. If first: Last line.

The USER mode also allows defining one of the 20 measurement images to be a predefined image, which is displayed always after a programmable time without user action. This switch back is performed even if in the meantime a change to the FULL or REDUCED mode was performed. This way an always equal appearance of the device can be defined in advance.

U1N I1 PF1 ΣP1incoming	
U2N I2 PF2 ΣP2incoming	
U3N I3 PF3 ΣP3incoming	
P1 P2 P3 P	
Q1 Q2 Q3 Q	
THD_U1 THD_U2 THD_U3 ΣQincoming	
dd.mm hh.mm ss ΣPincoming	

Example with 8 free assembled measurement images

LOOP mode

In the LOOP mode all of the measurement images of the USER mode are displayed one after the other with a programmable time delay. When a change to the LOOP mode is performed a possibly active preference display (USER mode) is deactivated. When leaving the LOOP mode the preference display is activated again.



USER and LOOP mode can be activated only, if at least one free measurement image has been defined !



7.5 Meter reading

A reading of the meter contents may be performed at any time, independent of the present selected display mode. When a meter content is displayed it [may be reset to zero](#) if the necessary rights have been granted during the configuration of the device.

Start reading: Press key  longer than 2s;

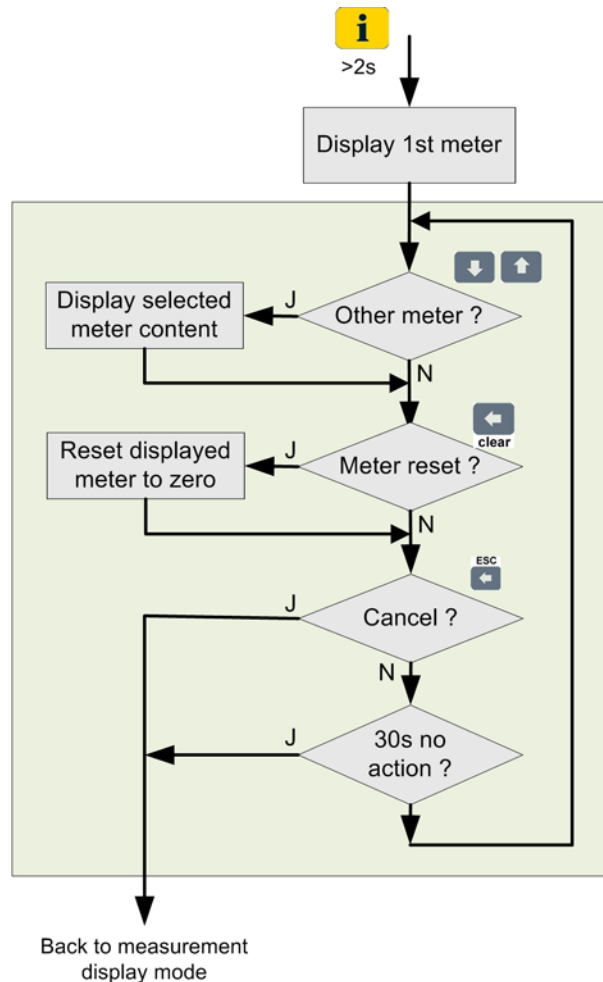
Stop reading: Press key  ;



- ▶ The first displayed meter is always active energy incoming, high tariff
- ▶ Using the keys  and  other values from the [list of meters](#) may be read as well



After a time of 30s with no key pressed the meter reading is automatically stopped !

7.6 Alarm handling

How alarms are handled is fixed during the configuration of the device. A detailed description about the alarming concept is here:

► [Monitoring und alarming](#)

7.6.1 Alarm state display on the device

The yellow state LED's are intended for alarming and alarm state display on-site. The displayed states are the result of the state information analysis, defined by the user in the logic module. The type of signaling is comparable to the operating philosophy in control rooms.

LED	Meaning
OFF	Alarm is not active
ON	Alarm is active and acknowledged
Fast FLASHING ¹⁾	Alarm is active but not yet acknowledged
Slow FLASHING ¹⁾	Alarm was temporarily active and not yet acknowledged

¹⁾ If "**acknowledgement of alarm LEDs required**" in the logic module configuration is not selected flashing is omitted.



The status display of the LED's is performed only, if the associated logic functions have been configured accordingly

7.6.2 Display of alarm texts

The displayed alarm texts are the result of the state information analysis, defined by the user in the logic module. The number of entries in the alarm text list depends on how many logic functions are used. If no function is used, when changing to the alarm display mode an appropriate error message is displayed and then the mode is terminated immediately. If logic functions are defined, the alarm list may contain up to four entries.

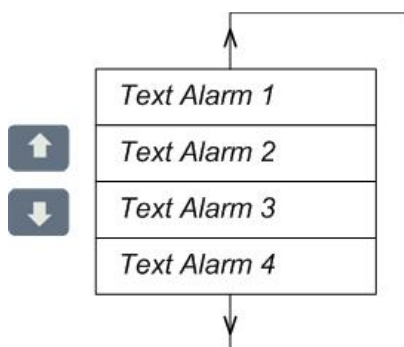

To each alarm a state text for the active and the inactive state is assigned. The table of the present alarm state texts contains, depending on the present state, either the text for the active or the inactive alarm. These may be retrieved and displayed on line 4. The first displayed alarm text after starting the alarm text display is the one with the highest priority (see flow diagram, next page).

Start alarm text display: Press shortly;

Stop alarm text display: Press key ;



After a time of 30s with no key pressed the display of alarm texts is automatically stopped !

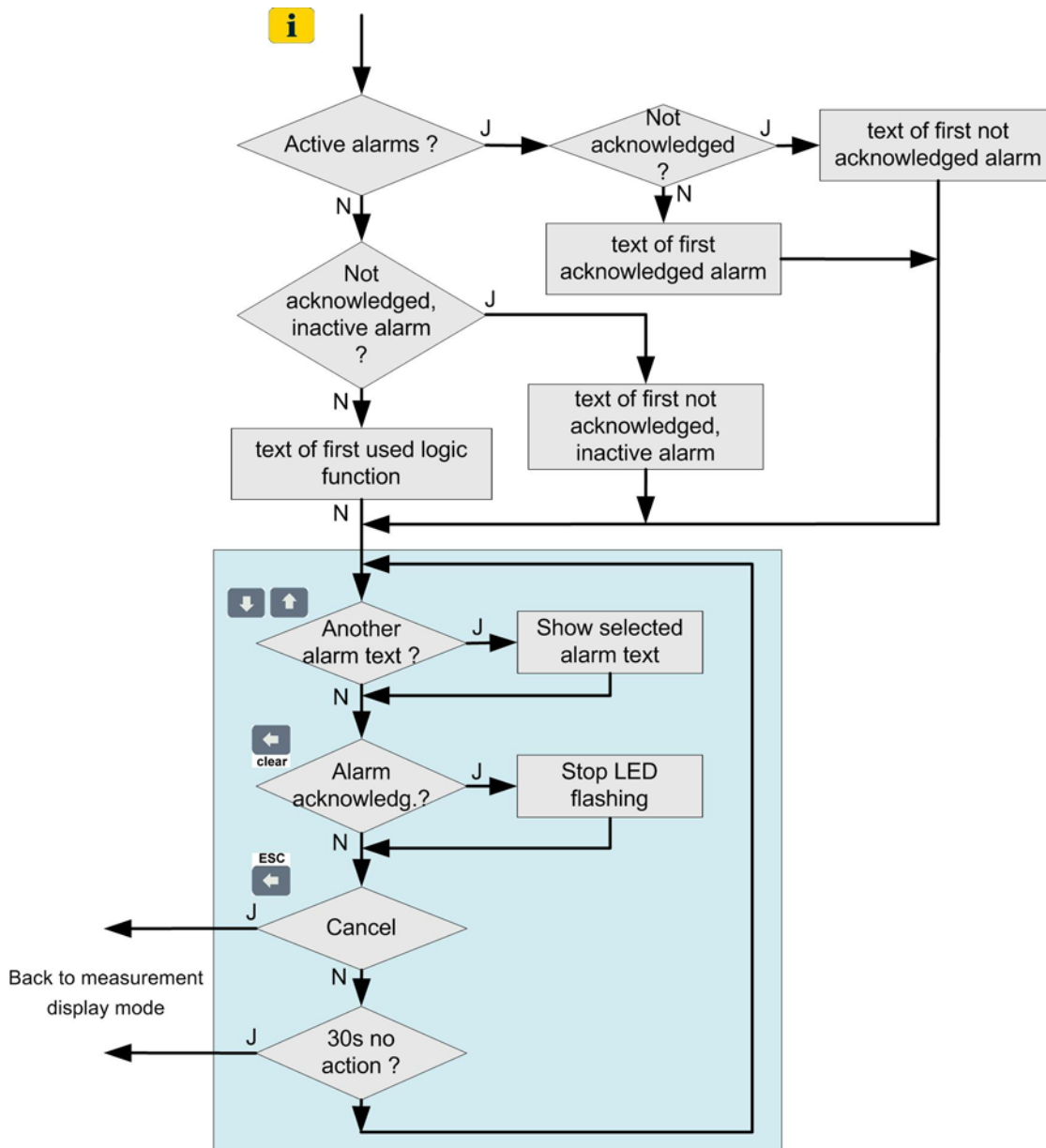

7.6.3 Acknowledgment of alarms via display

i Acknowledgment is not required if **"acknowledgement of alarm LEDs required"** in the logic module configuration is not selected.

The acknowledgment of alarms may be performed via the keys on the device. To do so, the alarm to acknowledge must be actually displayed.

ACKNOWLEDGMENT: Press key  (longer than 2s);

LED before acknowledgment	LED after acknowledgment
#C: Fast FLASHING	#B: ON
#D: Slow FLASHING	#A: OFF

i If the display is configured for alarm reset, the acknowledgment also undoes the possible alarm operation (e.g. the switching of a relay).

7.7 Resetting of measurements

The *APLUS* provides minimum and maximum values of different measured quantities as well as energy meters and operating hour counters. All of them may be reset during operation.

Basic principle

RESET: Press key  (longer than 2s) while the quantity to reset is displayed

Example: Reset of $U1N_{min}$ and $U1N_{max}$

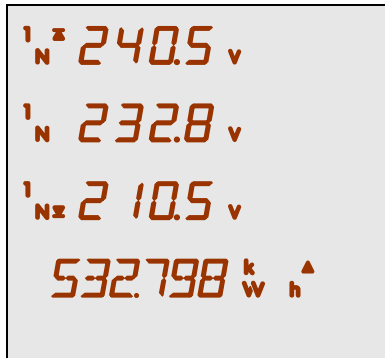







>> Absolute maximum value of $U1N$ since last reset



>> Present value of $U1N$

>> Absolute minimum value of $U1N$ since last reset

>> Displayed meter content

0:		Initial position as shown above
1:		240.5V starts flashing, on line 4 CLEAR? is flashing as well
2a:		Confirm reset of $U1N_{max}$, go to 3
2b:		No reset of $U1N_{max}$, go to 3
2c:		Cancel the reset procedure, go to 4
3:		210.5V starts flashing, on line 4 CLEAR? is flashing as well
3a:		Confirm reset of $U1N_{min}$, go to 4
3b:		Cancel the reset procedure, go to 4
4:		Resetting done

Example: Reset of meter content

0:		Display the meter to reset, see Meter reading
1:		On line 4 CLEAR? is displayed flashing
1a:		Confirm meter reset, go to 2
1b:		Cancel meter reset, go to 2
2:		Rücksetzen beendet



Resetting of measurements may be protected via the security system implemented in the device. For further information see [protection against device data changing](#).

7.8 Configuration

A complete configuration of the APLUS is possible via CB-Manager software only using the configuration interface of the device. On device side only the parameters described below may be modified. To do so, a configuration menu is provided.

Starting the configuration menu: Press  (longer than 2s);
menu

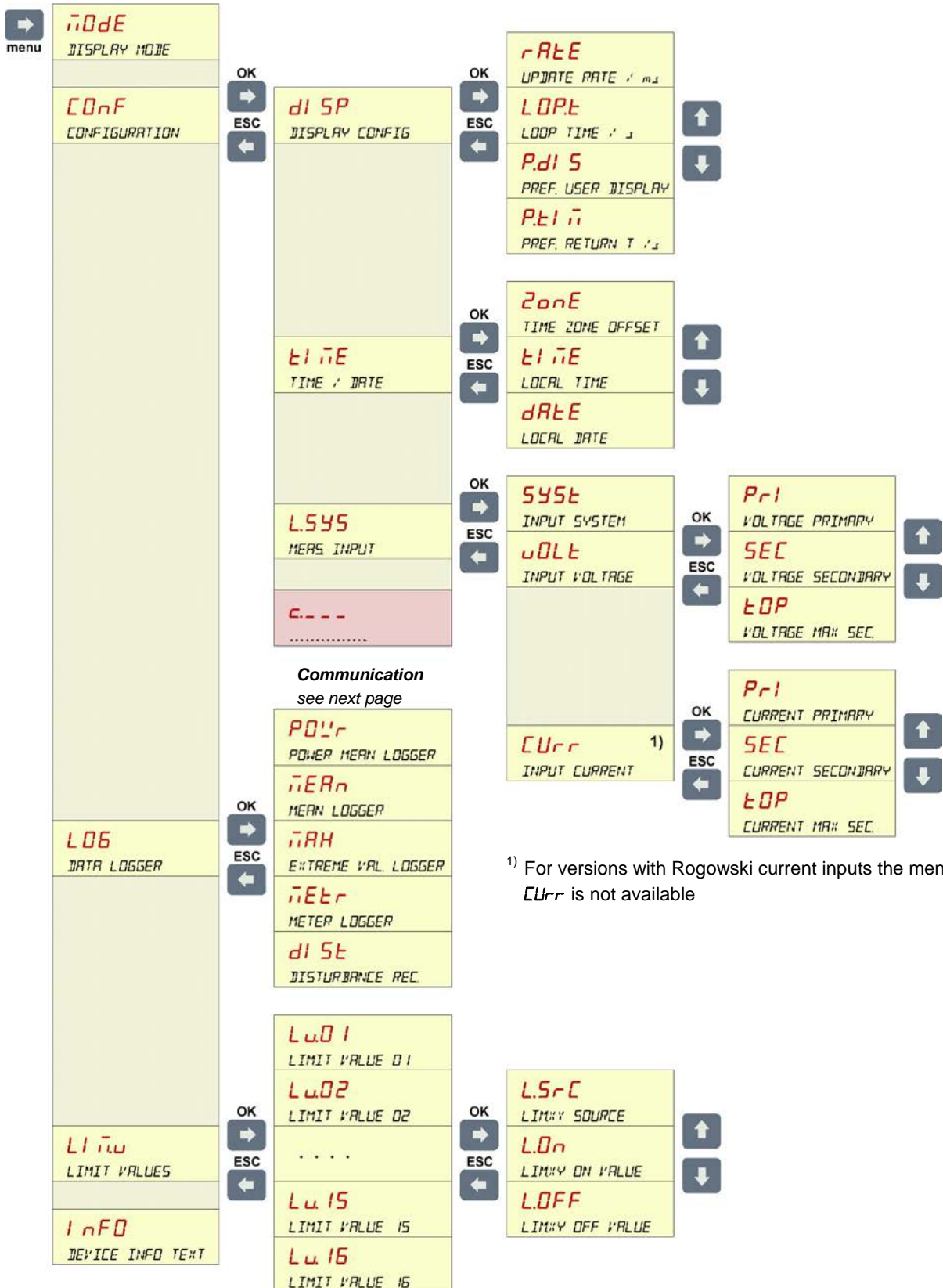

Overview of the navigation structure

Communication interface c. _ _ _

The possible settings depend on the device version selected. The following combinations may be available:

Bus connection	Menu 1	Menu 2
RS-485 (Modbus/RTU protocol)	c485	
Ethernet (Modbus/TCP protocol)	cEth	
RS-485 (Modbus/RTU protocol) + Profibus DP	c485	cPrD
RS-485 (Modbus/RTU protocol) + RS-485 (Modbus/RTU protocol)	c485	a485
Ethernet (Modbus/TCP protocol) + RS-485 (Modbus/RTU protocol)	cEth	a485

► RS-485 (Modbus/RTU interface)

A maximum of two RS-485 interfaces (X4 and / or X8) with Modbus/RTU protocol can be implemented in the device. These interfaces are independent. Their settings may be different, because they are not used in the same Modbus network.

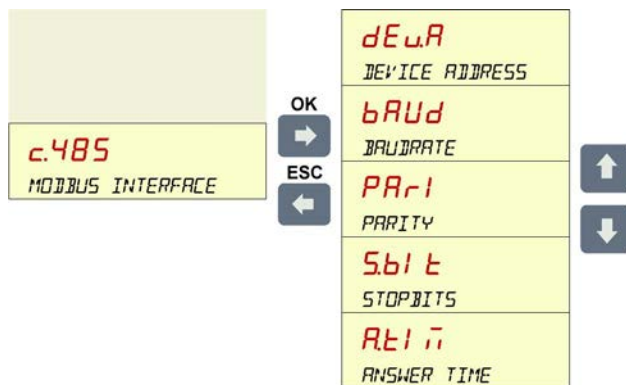

Menu	Range of values	Description
<i>Addr</i>	1...247	Modbus device address; must be unique within a Modbus network.
<i>bAUD</i>	2400,4800,9600,19.2k, 38.4k,57.6k,115.2k Bd	Transmission speed on the Modbus interface.
<i>PARI</i>	NONE, ODD, EVEN	Parity (none, odd, even)
<i>Sbit</i>	1Sb, 2Sb	Number of stop bits (Sb) per transmitted data byte.
<i>AETI</i>	0.1S, 64P, 32P, 16P, 8P, 4P, 2P, 1P S=seconds P=pause time	Delay time until the device sends an answer to a Modbus request. The time must be selected the way, that the requesting master is still able to understand the answer. Pause time = "Time to transmit 3.5 characters"

► Ethernet (Modbus/TCP-interface)

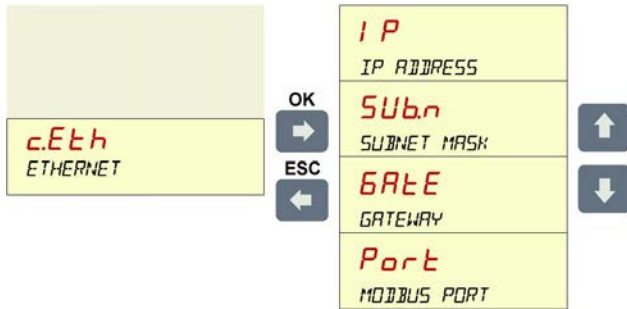

Menu	Range of values	Description
<i>IP</i>	z.B. 192.168.057.011	IP address: Must be unique for each device !
<i>SUBn</i>	z.B. 255.255.255.000	Subnet mask
<i>GATE</i>	z.B. 192.168.057.001	Gateway address
<i>Port</i>	1...65535	The TCP port for the Modbus/TCP communication, usually this is port 502.

► Profibus DP

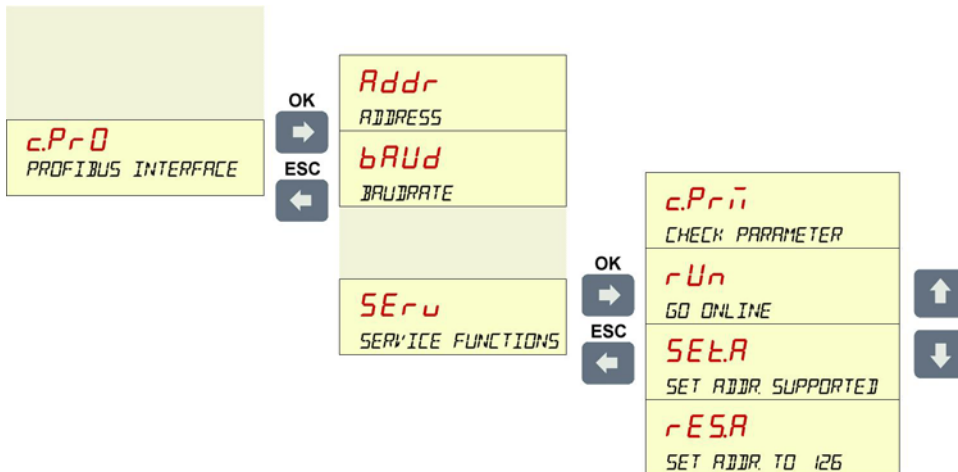

Menu	Range of values	Description
<i>Addr</i>	0...125	Device address; must be unique within the Profibus network.
<i>bAUD</i>	9.6 kBd ... 12 MBd	Transmission speed on the Profibus interface. The present value set is displayed (auto detection).
<i>c.Prü</i>	On / OFF	<i>Check_User_Prm</i> : The parameters of the control system will be used (On) or declined (OFF). Default: On.
<i>rUn</i>	On / OFF	<i>Go_Online</i> : Device is able to connect to the control system (On) or is separated from the Profibus system (OFF). Default: On.
<i>SEtA</i>	On / OFF	<i>Set_Slave_Addr_Supp</i> : Setting of the device address via Profibus master is allowed (On) or disabled (OFF). Default: On.
<i>rESA</i>	On / OFF	If On the device address is reset to the factory setting (126). In this case the device is no longer able to communicate with the control system.

Further menu parameters

Menu	Range of values	Description
MODE DISPLAY MODE	FULL, rEdU, USEr, LOOP see Display modes	Display mode of the device. USER and LOOP mode can be activated only, if at least one free measurement image has been defined !
rAtE UPDATE RATE / m_s	100...5000	Refresh rate of the display. This is the time gap between two updates of the display.
LOP.t LOOP TIME / s	2...10s	The time gap between changes of the displayed measurement image, if the LOOP mode is active.
P.dI S PREF. USER DISPLAY	1...20	Number of the preferred image of the USER mode which is automatically displayed after "P.tiM" without user action. LOOP mode must be activated.
P.tI n PREF. RETURN T / s	10...255	Time without user action until the USER image "P.dIS" is automatically displayed in the LOOP mode.
SYS.t INPUT SYSTEM	see Inputs	System connected to the device. A modification may cause that e.g. limit values or outputs will no longer properly, because the associated measured quantities are no longer valid. Possibly also the existing wiring must be changed.
P.rI VOLTAGE PRIMARY CURRENT PRIMARY	< 1000 MV < 200.0 kA	Rated primary voltage of the voltage transformer connected upstream. If the measurement is done directly this value must be the same as "SEC".
SEC VOLTAGE SECONDARY CURRENT SECONDARY	50...832V _{LL} / 28,9...480.3 _{LN} 1...7.5 A	Rated secondary value of the voltage transformer connected upstream.
tOP VOLTAGE MAX SEC. CURRENT MAX SEC.	SEC ≤ tOP ≤ (max. U) or SEC ≤ tOP ≤ (max. I)	Maximum value which should be measurable on the secondary side of the voltage transformer. Maximum values see "SEC".
L.S.rC LIMITY SOURCE .		The measured quantity assigned to the limit value. Can not be modified. XY=01...16.
LOn LIMITY ON VALUE .	Depends on quantity	Limit for ON state of limit value XY; XY=01...16. See Limit values .
LOFF LIMITY OFF VALUE	Depends on quantity	Limit for OFF state of limit value XY; XY=01...16. See Limit values .
I nFO DEVICE INFO TEXT		Here the configured short description text (TAG) of the device is displayed. Can be modified via CB-Manager only.
POU.r POWER MEAN LOGGER.	On / OFF	Switch on (On) or off (OFF) recording of power mean values logger.
MEAn MEAN LOGGER.	On / OFF	Switch on (On) or off (OFF) recording of mean values logger.
EXt.r EXTREME VAL. LOGGER	On / OFF	Switch on (On) or off (OFF) recording of extreme values logger.
METER METER LOGGER.	On / OFF	Switch on (On) or off (OFF) recording of meter logger.
dISt DISTURBANCE REC.	On / OFF	Switch on (On) or off (OFF) recording of disturbance logger.

Setting time and date

All time information stored in the device is referenced to UTC¹⁾ (**U**niversal **T**ime **C**oordinated). For a better understanding the time/date information displayed on the display can be converted to local time by defining a time zone offset. This offset is added to the internal UTC time before the time information is displayed. Keep in mind that the offset may be variable if daylight saving time is used locally (see below).

Hint: If time is set via CB-Manager software the difference between local time and UTC rather results from the local time settings of the PC than from the time zone offset configured via display. There may be a discrepancy.

Menu: <i>LI nE</i>	Range of values	Description
<i>20nE</i> TIME ZONE OFFSET	-840...840 [min]	Offset of the local time to UTC time ¹⁾ , which is used as the time reference in the device.
<i>LI nE</i> TIME		Setting of hours, minutes and seconds of the built-in real-time clock.
<i>dAEE</i> DATE		Setting of day, month and year of the built-in real-time clock.

¹⁾ UTC (**U**niversal **T**ime **C**oordinated)

Sometimes UTC is called world time as well. The reference corresponds to the Greenwich Mean Time (GMT). The time zones of the world nowadays are all referenced with an offset to UTC. UTC time doesn't use time shifts, which may occur due to a change to daylight saving time.

Example: In Switzerland the CET (Central European Time) is valid, which has an offset of +1[h] to UTC. But during half of the year the CEST (Central European Summer Time) is used, which has an offset of +2[h] to the UTC time used in the device.

7.8.1 Selection of the parameter to edit

To modify a value you have to navigate through the menu tree by means of the arrow keys until the appropriate parameter is displayed. For the parameter selected on line 4 a detailed description is displayed.



If the description text on line 4 is wider than 8 characters it's shown as a ticker.





<pre> nODE : CONF LI nE CONFIGURATION </pre>	>> Previous menu. If blank: End of list >> Presently selectable submenu. Choose via >> Next menu. If blank: End of list >> Description of the submenu of line 2 (ticker)
--	---

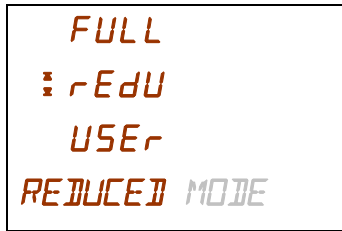

Depending on the parameter either a discrete value from a list may be selected or the associated numerical value may be modified.

7.8.2 Discrete selection

The configuration of parameters, which can accept a limited number of values only, is implemented by means of selecting a value from a list. In the example shown below to modify the display mode normally the discrete values FULL, REDU, USER and LOOP are available.

Example: Change MODE (DISPLAY MODE) from *rEdU* to *USER*

	>>  Previous element. If blank: End of selection list >> Present selection. Change via  ^{OK} >>  Next element. If blank: End of selection list >> Description of the selection on line 2 (ticker)
---	--



	<i>rEdU</i> starts flashing
	<i>USER</i> is displayed flashing as present selection
	<i>USER</i> adopted as the new display mode, displayed non flashing









-  ▶ The **modification mode** is left automatically after a time of 15s with no key pressed and the previous displayed menu is shown again !
- ▶ The **configuration mode** is left automatically after a time of 30s with no key pressed and the measurement display is shown again !

7.8.3 Setting value

For quantities which may accept a huge number of possible values, the present value may be modified digit per digit. In most cases a possible range of values is predefined, which limits possible input values.

Example: Modification of limit value 1 from 1.205 MW to 123.0 kW

	>> Changeable value. Start modification via  ^{OK} >> Description of the value on line 2 (ticker)
---	---

	First digit (1) starts flashing
	Second digit (2) starts flashing
	Third digit (0) starts flashing. Increase to 3 using 
	Fourth digit (5) starts flashing. Decrease to 0 using 
	M starts flashing. Reduce to k with one position after decimal point using 
	123.0 kW adopted as new limit value, displayed non flashing

-  ▶ The **modification mode** is left automatically after a time of 15s with no key pressed and the previous displayed menu is shown again !
- ▶ The **configuration mode** is left automatically after a time of 30s with no key pressed and the measurement display is shown again !

7.9 Data logger

The data logger offers a periodical acquisition of measurement data, such as recording load profiles, measurement fluctuations or meter readings as well as event triggered recordings of alarm states or disturbances. This storage medium used is an SD card, which allows almost unlimited recordings and an easy exchanging on-site.

The following recording types are supported:

Logger	Triggered by...	Recording	Resettable
Power mean values	Interval t1	ON / OFF	YES
Configurable mean values quantities	Interval t2	ON / OFF	YES
Extreme values	Interval t3	ON / OFF	YES
Meter readings	Calendar based	ON / OFF	YES
Disturbance recorder	Event	ON / OFF	YES
Alarm / event list	Event	always active	NO
Operator list	Event	always active	NO

7.9.1 Activation of data logger recording

By configuring the different data loggers their state will not be changed. If it was active it remains active, if it was inactive it remains inactive. The activation / deactivation of a specific logger may be performed via PC software or via the [local programming menu](#). Only via PC software, respectively by using the corresponding commands via the configuration interface, contents of the individual logger can be reset. Lists are exceptional, because they are always active to prevent manipulations. They record events in endless mode and can't be reset.

7.9.2 SD card

The device is supplied with a 2 GByte SD card, which allows long-term recordings. The device can be equipped with all other SD cards available.

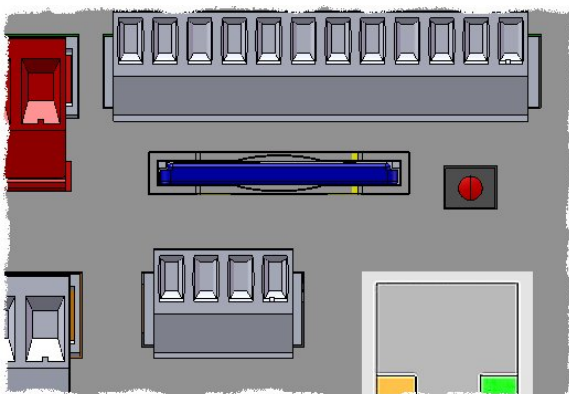

The red LED of the key located next to the SD card signals that the logger is active. During writing to the card the LED becomes dark for a short time.

To exchange an SD card the key must be pressed. As soon as the red LED becomes dark, the SD card can be removed and the new card inserted. Data can't be latched in the device. Therefore there is no recording for the time no card is present in the device.

Status messages on LED display	Meaning
<code>NO_CARD</code>	The logger is active, but no SD card has been inserted.
<code>CARDLOCK</code>	The SD card inserted is write-protected.
<code>CARD_FULL</code>	For at least one of the logger parts, which are not used in endless mode, the assigned memory space is full. No more data can be recorded.
<code>CARD_ERR</code>	Faulty SD card. Possibly no more data will be recorded.

7.9.3 Access to logger data

Only for device versions with Ethernet a direct access to the logger data via interface is possible. For all other versions you have to remove the SD card first and to access the recorded data using an internal or external card reader. The analysis of the data is performed using the CB-Analyzer software.

7.9.4 Logger data analysis

The analysis of recorded logger data can be done using the PC software CB-Analyzer.



The file "Read-me-first" provides all necessary information for the installation of the CB-Analyzer software and assistance for possible problems.

Functionality of the CB-Analyzer software

This .NET-based software facilitates the data acquisition and analysis of the optional data loggers and lists of SINEAX CAM and APLUS. The data read from the devices will be stored in a database. The program is capable of processing several devices simultaneously.

- ▶ Acquisition of logger and list data of several devices
- ▶ Storage of the data in a database (Access, SQLClient)
- ▶ Different analyzing options of the acquired data, also across devices
- ▶ Report generation in list or graphic format
- ▶ Selectable time range in the preparation of reports
- ▶ Export of report data to Excel or as an Acrobat PDF file

The CB-Analyzer software provides a comprehensive help facility, which describes in detail the operation of the software. Below a screen-shot is shown, which shows as an example the graphical analysis of the power demand of a factory over one week.

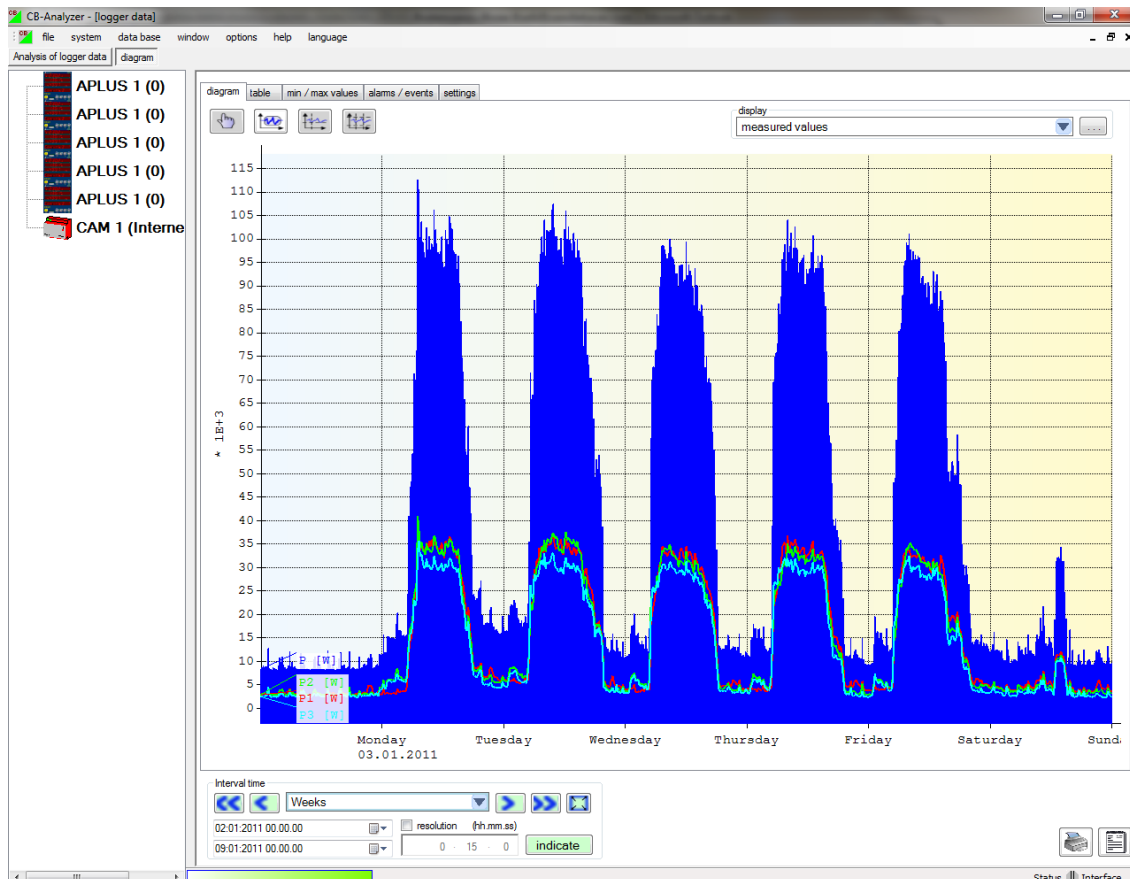

8. Service, maintenance and disposal

8.1 Protection of data integrity

The *APLUS* supports security mechanism, which serve to prevent manipulation or undesired modifications of device data.

► [Protection against device data modifications](#)

8.2 Calibration and new adjustment

Each device is adjusted and checked before delivery. The condition as supplied to the customer is measured and stored in electronic form.

The uncertainty of measurement devices may be altered during normal operation if, for example, the specified ambient conditions are not met. If desired, in our factory a calibration can be performed, including a new adjustment if necessary, to assure the accuracy of the device.

8.3 Cleaning

The display and the operating keys should be cleaned in regular intervals. Use a dry or slightly moist cloth for this.



Damage due to detergents

Detergents may not only affect the clearness of the display but also can damage the device. Therefore, do not use detergents.

8.4 Battery

The device contains a battery for buffering the internal clock. It cannot be changed by the user. The replacement can be done at the factory only.

8.5 Disposal

The product must be disposed in compliance with local regulations. This particularly applies to the built-in battery.

9. Technical data

Inputs

Nominal current:	adjustable 1...5 A
Maximum:	7.5 A (sinusoidal)
Consumption:	$\leq I^2 \times 0.01 \Omega$ per phase
Overload capacity:	10 A continuous 100 A, 10 x 1 s, interval 100 s

Current measurement via Rogowski coils

Range: 0...3000A, auto-ranging

See operating instructions of Rogowski coil ACF3000 for further information

Nominal voltage:	57.7...400 V _{LN} , 100...693 V _{LL}
Maximum:	480 V _{LN} , 832 V _{LL} (sinusoidal)
Consumption:	$\leq U^2 / 3 M\Omega$ per phase
Impedance:	3 M Ω per phase
Overload capacity:	480 V _{LN} , 832 V _{LL} continuous 600 V _{LN} , 1040 V _{LL} , 10 x 10 s, interval 10s 800 V _{LN} , 1386 V _{LL} , 10 x 1 s, interval 10s

Systems:	Single phase Split phase (2-phase system) 3-wire, balanced load 3-wire, unbalanced load 3-wire, unbalanced load, Aron connection 4-wire, balanced load 4-wire, unbalanced load 4-wire, unbalanced load, Open-Y
-----------------	---

Nominal frequency:	45... <u>50 / 60</u> ...65Hz
Measurement TRMS:	Up to the 63rd harmonic

Measurement uncertainty



Version with Rogowski current inputs

The additional uncertainty of the Rogowski coils ACF 3000 is not included in the following specifications: See operating instructions of Rogowski coil ACF3000

*Reference conditions: Ambient 15...30°C,
(acc. IEC/EN 60688) sinusoidal input signals (form factor 1.1107)
Measurement over 8 cycles, no fixed system frequency for sampling,
PF=1, frequency 50...60Hz*

Voltage, current:	$\pm (0.08\% MV + 0.02\% MR)$ ^{1) 2)}
Power:	$\pm (0.16\% MV + 0.04\% MR)$ ^{3) 2)}
Power factor:	$\pm 0.1^\circ$ ⁴⁾
Frequency:	± 0.01 Hz
Imbalance U, I:	$\pm 0.5\%$
Harmonics:	$\pm 0.5\%$
THD Voltage:	$\pm 0.5\%$
TDD Current:	$\pm 0.5\%$
Active energy:	Class 0.5S, EN 62053-22
Reactive energy:	Class 2, EN 62053-23

Measurement with fixed system frequency:

General	\pm Basic uncertainty x (F _{konfig} -F _{ist}) [Hz] x 10
Imbalance U	$\pm 1.5\%$ up to ± 0.5 Hz
Harmonics	$\pm 1.5\%$ up to ± 0.5 Hz
THD, TDD	$\pm 2.0\%$ up to ± 0.5 Hz

¹⁾ MV: Measured value, MR: measurement range (maximum)

²⁾ Additional uncertainty of 0.1% MV if neutral wire not connected (3-wire connections)

³⁾ MR: maximum voltage x maximum current

⁴⁾ Additional uncertainty of 0.1° if neutral wire not connected (3-wire connections)

Zero suppression, range limitations

The measurement of specific quantities is related to a pre-condition which must be fulfilled, that the corresponding value can be determined and sent via interface or displayed. If this condition is not fulfilled, a default value is used for the measurement.

Quantity	Condition	Default
Voltage	$U_x < 1\% U_{x_{max}}$	0.00
Current	$I_x < 0,1\% I_{x_{rated}}$	0.00
PF	$S_x < 1\% S_{x_{max}}$	1.00
QF, LF, $\tan\phi$	$S_x < 1\% S_{x_{max}}$	0.00
Frequency	voltage and/or current input too low ¹⁾	44.90
Voltage unbalance	$U_x < 5\% U_{x_{max}}$	0.00
Current unbalance	mean value of phase currents $< 5\% I_{x_{max}}$	0.00
Phase angle	at least one voltage $U_x < 5\% U_{x_{max}}$	120°
Harmonics U, THD-U	fundamental $< 5\% U_{x_{max}}$	0.00

¹⁾ specific level depends on the device configuration

Power supply

via plug-in terminal

Nominal voltage:

100...230V AC $\pm 15\%$, 50...400Hz

24...230V DC $\pm 15\%$

Consumption:

$\leq 7...10$ VA, depending on the device hardware used

I/O interface

Available inputs and outputs

Basic unit	- 1 relay output, changeover contact - 1 digital output (fixed) - 1 digital input (fixed)
I/O extension 1	- 2 relay outputs, changeover contact - 4 bipolar analog outputs - 2 digital inputs/outputs, each configurable as input or output
I/O extension 2	- 2 relay outputs, changeover contact - 6 digital inputs/outputs, each configurable as input or output

Analog outputs

	via plug-in terminals, galvanically isolated
Linearization:	Linear, quadratic, kinked
Range:	± 20 mA (24 mA max.), bipolar
Uncertainty:	$\pm 0.2\%$ of 20 mA
Burden:	$\leq 500 \Omega$ (max. 10 V / 20 mA)
Burden influence:	$\leq 0.2\%$
Residual ripple:	$\leq 0.4\%$
Response time:	60...100ms (for 2 cycles averaging time of RMS values)

Relays

	via plug-in terminals
Contact:	changeover contact, bistabil
Load capacity:	250 V AC, 2 A, 500 VA 30 V DC, 2 A, 60 W

Digital inputs/outputs via plug-in terminals

Digital inputs (acc. EN 61 131-2 DC 24 V type 3):

Nominal voltage	12 / 24 V DC (30 V max.)
Logical ZERO	- 3 up to + 5 V
Logical ONE	8 up to 30 V

Digital outputs (partly acc. EN 61 131-2):

Nominal voltage	12 / 24 V DC (30 V max.)
Nominal current	50 mA (60 mA max.)
Load capability	400 Ω ... 1 M Ω

Interfaces

Modbus/RTU X4 / X8 via plug-in terminals
Protocol: Modbus RTU
Physics: RS-485, max. 1200m (4000 ft)
Baud rate: 2'400, 4'800, 9'600, 19'200, 38'400, 57'600, 115'200 Baud
Number of participants: ≤ 32

Profibus X8 via 9-pin D-sub socket
Protocol: Profibus DP
Physics: RS-485, 100...1200m (depending on baud rate and cable type used)
Baud rate: Automatic baud rate recognition (9.6kBit/s ... 12MBit/s)
Address: 0...125 (default: 126)

Ethernet X4 via RJ45 connector
Protocol: Modbus/TCP, NTP
Physics: Ethernet 100BaseTX
Mode: 10/100 MBit/s, full/half duplex, auto-negotiation

Internal clock (RTC)

Uncertainty: ± 2 minutes / month (15 up to 30°C)
Synchronization: via Synchronization pulse
Running reserve: > 10 years

Ambient conditions, general information

Operating temperature: -10 up to 15 up to 30 up to + 55°C
Storage temperature: -25 up to + 70°C
Temperature influence: 0.5 x measurement uncertainty per 10 K
Long term drift: 0.5 x measurement uncertainty per year
Others: Usage group II (EN 60 688)
Relative humidity: < 95% no condensation
Altitude: ≤ 2000 m max.
Device to be used indoor only !

Mechanical attributes

Orientation: Any
Housing material: Polycarbonat (Makrolon)
Flammability class: V-0 acc. UL94, non-dripping, free of halogen
Weight: 500 g
Dimensions: [Dimensional drawings](#)

Vibration withstand (test according to DIN EN 60 068-2-6)

Acceleration: ± 2 g
Frequency range: 10 ... 150 ... 10 Hz, rate of frequency sweep: 1 octave/minute
Number of cycles: 10 in each of the 3 axes

Security

The current inputs are galvanically isolated from each other

Protection class:	II (protective insulation, voltage inputs via protective impedance)
Pollution degree:	2
Protection:	IP64 (front), IP40 (housing), IP20 (terminals)
Measurement category:	CAT III, CATII (relays)
Rated voltage (versus earth):	power supply: 265 V AC Relays: 250 V AC I/O's: 30 V DC
Test voltages:	DC, 1 min., acc. IEC/EN 61010-1 7504V DC, power supply versus inputs U, I 5008V DC, power supply versus bus, I/O's, relays 6030V DC, inputs U versus inputs I 4690V DC, inputs U after protective impedance versus bus, I/O's, relays 7504V DC, inputs U versus relays 7504V DC, inputs I versus bus, I/O's, relays 6030V DC, inputs I versus inputs I 3130V DC, relay versus relay, bus, I/O's

Applied regulations, standards and directives

IEC/EN 61 010-1	Safety regulations for electrical measuring, control and laboratory equipment
IEC/EN 60 688	Electrical measuring transducers for converting AC electrical variables into analog or digital signals
DIN 40 110	AC quantities
IEC/EN 60 068-2-1/ -2/-3/-6/-27:	Ambient tests -1 Cold, -2 Dry heat, -3 Damp heat, -6 Vibration, -27 Shock
IEC/EN 60 529	Protection type by case
IEC/EN 61 000-6-2/ 61 000-6-4:	Electromagnetic compatibility (EMC) Generic standard for industrial environment
IEC/EN 61 131-2	Programmable controllers - equipment, requirements and tests (digital inputs/outputs 12/24V DC)
IEC/EN 61 326	Electrical equipment for measurement, control and laboratory use - EMC requirements
IEC/EN 62 053-31	Pulse output devices for electromechanical and electronic meters (S0 output)
UL94	Tests for flammability of plastic materials for parts in devices and appliances
2011/65/EU (RoHS)	EU directive on the restriction of the use of certain hazardous substances

Warning

This is a class A product. In a domestic environment this product may cause radio interference in which case the user may be required to take adequate measures.

This device complies with part 15 of the FCC:

Operation is subject to the following two conditions: (1) This device may not cause harmful interference, and (2) this device must accept any interference received, including interference that may cause undesired operation.

This Class A digital apparatus complies with Canadian ICES-0003.

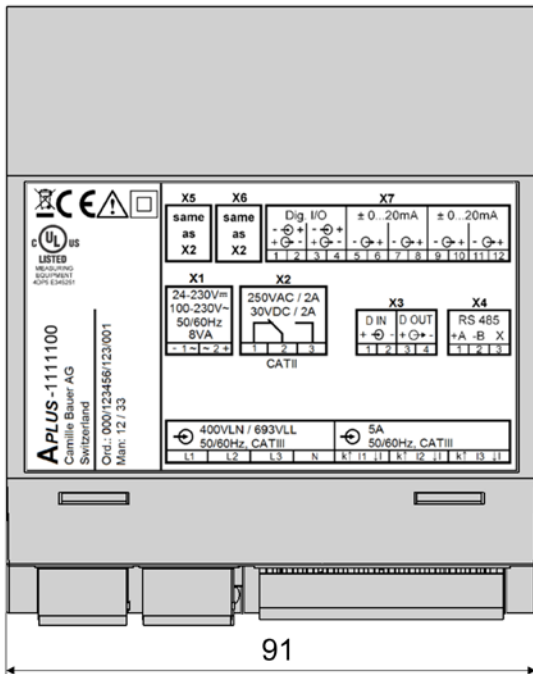
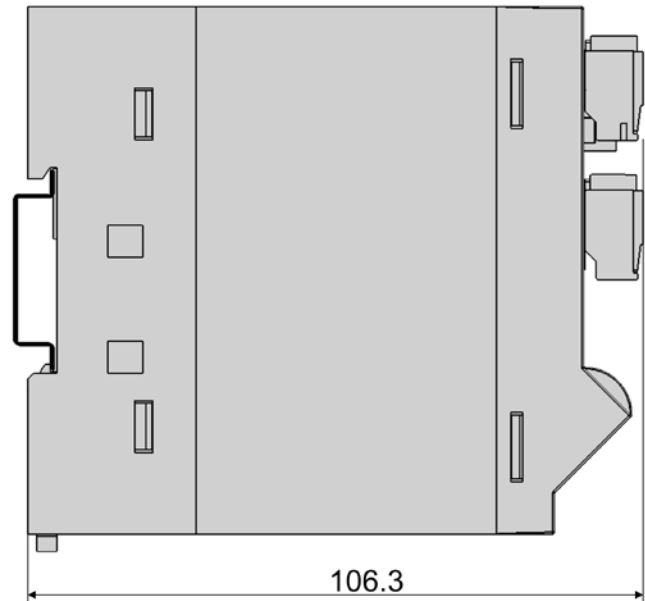
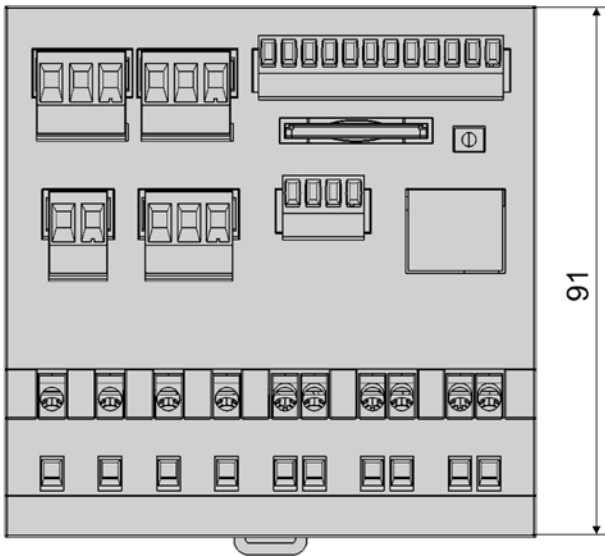

APLUS without display

Annex

A Description of measured quantities

Used abbreviations

1L	Single phase system
2L	Split phase; system with 2 phases and centre tap
3Lb	3-wire system with balanced load
3Lu	3-wire system with unbalanced load
3Lu.A	3-wire system with unbalanced load, Aron connection (only 2 currents connected)
4Lb	4-wire system with balanced load
4Lu	4-wire system with unbalanced load
4Lu.O	4-wire system with unbalanced load, Open-Y (reduced voltage connection)

A1 Basic measurements

These measured quantities are determined using the configured measurement time (2...1024 cycles, in steps of 2 cycles). If a measurement is available depends on the selected system.

Depending on the measured quantity also minimum and maximum values are determined and non-volatile stored with timestamp. These values may be reset by the user via the display unit or via the configuration interface, see [resetting of measurements](#).

Measurement	present	max	min	1L	2L	3Lb	3Lu	3Lu.A	4Lb	4Lu.O	4Lu
Voltage U	•	•	•	√	√				√		
Voltage U _{1N}	•	•	•		√					√	√
Voltage U _{2N}	•	•	•		√					√	√
Voltage U _{3N}	•	•	•							√	√
Voltage U ₁₂	•	•	•			√	√	√		√	√
Voltage U ₂₃	•	•	•			√	√	√		√	√
Voltage U ₃₁	•	•	•			√	√	√		√	√
Zero displacement voltage U _{NE}	•	•									√
Current I	•	•		√		√			√		
Current I1	•	•			√		√	√		√	√
Current I2	•	•			√		√	√		√	√
Current I3	•	•					√	√		√	√
Bimetal current 1...60min. IB	•	•		√		√			√		
Bimetal current 1...60min. IB1	•	•			√		√	√		√	√
Bimetal current 1...60min. IB2	•	•			√		√	√		√	√
Bimetal current 1...60min. IB3	•	•					√	√		√	√
Neutral current I _N	•	•								√	√
Active power P	•	•		√	√	√	√	√	√	√	√
Active power P1	•	•			√					√	√
Active power P2	•	•			√					√	√
Active power P3	•	•								√	√
Reactive power Q	•	•		√	√	√	√	√	√	√	√
Reactive power Q1	•	•			√					√	√
Reactive power Q2	•	•			√					√	√
Reactive power Q3	•	•								√	√
Apparent power S	•	•		√	√	√	√	√	√	√	√
Apparent power S1	•	•			√					√	√
Apparent power S2	•	•			√					√	√
Apparent power S3	•	•								√	√
Frequency F	•	•	•	√	√	√	√	√	√	√	√

Measurement	present	max	min	1L	2L	3Lb	3Lu	3Lu.A	4Lb	4Lu.O	4Lu
Power factor PF	•			✓	✓	✓	✓	✓	✓	✓	✓
Power factor PF1	•				✓					✓	✓
Power factor PF2	•				✓					✓	✓
Power factor PF3	•									✓	✓
PF incoming inductive			•	✓	✓	✓	✓	✓	✓	✓	✓
PF incoming capacitive			•	✓	✓	✓	✓	✓	✓	✓	✓
PF outgoing inductive			•	✓	✓	✓	✓	✓	✓	✓	✓
PF outgoing capacitive			•	✓	✓	✓	✓	✓	✓	✓	✓
Reactive power factor QF	•			✓	✓	✓	✓	✓	✓	✓	✓
Reactive power factor QF1	•				✓					✓	✓
Reactive power factor QF2	•				✓					✓	✓
Reactive power factor QF3	•									✓	✓
Load factor LF	•			✓	✓	✓	✓	✓	✓	✓	✓
Load factor LF1	•				✓					✓	✓
Load factor LF2	•				✓					✓	✓
Load factor LF3	•									✓	✓
$U_{\text{mean}}=(U1N+U2N)/2$	•				✓						
$U_{\text{mean}}=(U1N+U2N+U3N)/3$	•									✓	✓
$U_{\text{mean}}=(U12+U23+U31)/3$	•						✓	✓			
$I_{\text{mean}}=(I1+I2)/2$	•				✓						
$I_{\text{mean}}=(I1+I2+I3)/3$	•						✓	✓		✓	✓
Phase angle between U1 and U2	•					✓	✓	✓		✓	✓
Phase angle between U2 and U3	•					✓	✓	✓		✓	✓
Phase angle between U3 and U1	•					✓	✓	✓		✓	✓
Maximum $\Delta U \ll U_m$ ¹⁾	•	•				✓	✓	✓			✓
Maximum $\Delta I \ll I_m$ ²⁾	•	•					✓			✓	✓
IMS, Average current with sign of P	•						✓	✓		✓	✓

¹⁾ maximum deviation from the mean value of all voltages (see A3)

²⁾ maximum deviation from the mean value of all currents (see A3)

Power factors

The **power factor PF** gives the relation between active and apparent power. If there are no harmonics present in the system, it corresponds to the $\cos\varphi$ (see also [Reactive power](#)). The PF has a range of $-1...0...+1$, where the sign gives the direction of energy flow.

The **load factor LF** is a quantity derived from the PF, which allows making a statement about the load type. Only this way it's possible to measure a range like 0.5 capacitive ... 1 ... 0.5 inductive in a non-ambiguous way.

The **reactive power factor QF** gives the relation between reactive and apparent power.

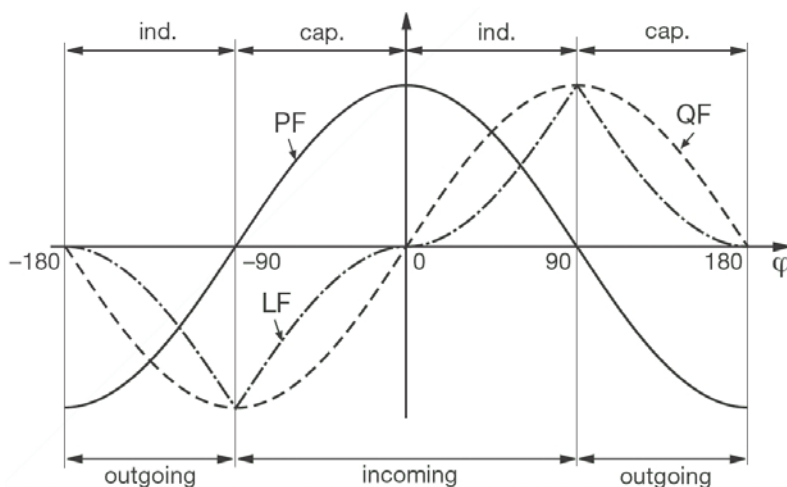

Zero displacement voltage U_{NE}

Starting from the generating system with star point E (which is normally earthed), the star point (N) on load side is shifted in case of unbalanced load. The zero displacement voltage between E and N may be determined by a vectorial addition of the voltage vectors of the three phases:

$$U_{NE} = - (U_{1N} + U_{2N} + U_{3N}) / 3$$

A displacement voltage may also occur due to harmonics of order 3, 9, 15, 21 etc., because the dedicated currents add in the neutral wire.

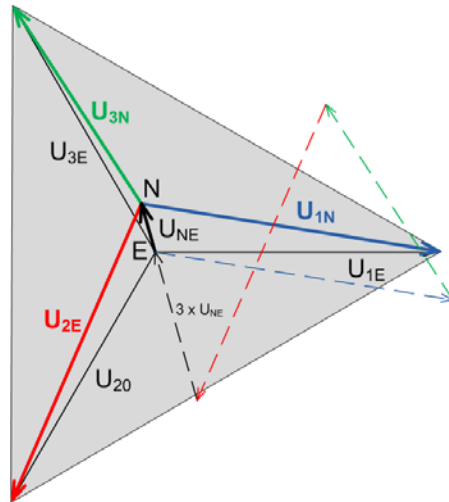

Earth fault monitoring in IT systems

Via the determination of the zero displacement voltage it's possible to detect a first earth fault in an unearthed IT system. To do so, the device is configured for measurement in a 4-wire system with unbalanced load and the neutral connector is connected to earth. In case of a single phase earth fault there is a resulting zero displacement voltage of $U_{LL} / \sqrt{3}$. The alarming may be done e.g. by means of a relay output.

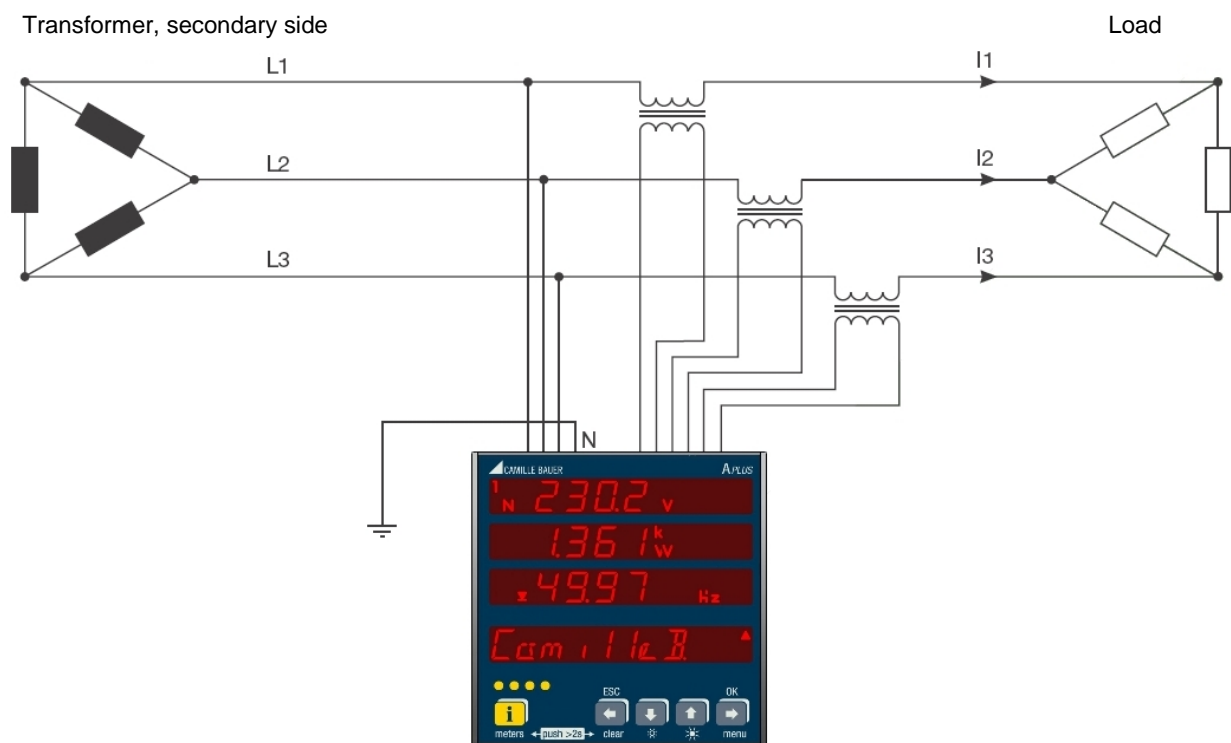

Because in case of a fault the voltage triangle formed by the three phases does not change the voltage and current measurements as well as the system power values will be still measured and displayed correctly. Also the meters carry on to work as expected.

The method is suited to detect a fault condition during normal operation. A declination of the isolation resistance may not be detected this way. This should be measured during a periodical control of the system using a mobile system.

Another possibility to analyze fault conditions in a grid offers the method of the [symmetrical components](#) as described in A3.

A2 Harmonic analysis

Measurement	present	max	1L	2L	3Lb	3Lu	3Lu.A	4Lb	4Lu.O	4Lu
THD Voltage U1N/U	●	●	√	√				√	√	√
THD Voltage U2N	●	●	√	√					√	√
THD Voltage U3N	●	●							√	√
THD Voltage U12	●	●			√	√	√			
THD Voltage U23	●	●			√	√	√			
THD Voltage U31	●	●			√	√	√			
TDD Current I1/I	●	●	√	√	√	√	√	√	√	√
TDD Current I2	●	●		√		√	√		√	√
TDD Current I3	●	●				√	√		√	√
Harmonic contents 2nd...50th U1N/U	●	●	√	√				√	√	√
Harmonic contents 2nd...50th U2N	●	●		√					√	√
Harmonic contents 2nd...50th U3N	●	●							√	√
Harmonic contents 2nd...50th U12	●	●			√	√	√			
Harmonic contents 2nd...50th U23	●	●			√	√	√			
Harmonic contents 2nd...50th 2.-50. U31	●	●			√	√	√			
Harmonic contents 2nd...50th 2.-50. I1/I	●	●	√	√	√	√	√	√	√	√
Harmonic contents 2nd...50th 2.-50. I2	●	●		√		√	√		√	√
Harmonic contents 2nd...50th 2.-50. I3	●	●				√	√		√	√

Harmonics

Harmonics are multiple of the fundamental resp. system frequency. They arise if non-linear loads, such as RPM regulated drives, rectifiers, thyristor controlled systems or fluorescent lamps are present in the power system. Thus undesired side effects occur, such as additional thermal stress to operational resources or electrical mains, which lead to an advanced aging or even damage. Also the reliability of sensitive loads can be affected and unexplainable disturbances may occur. In industrial networks the image of the harmonics gives good information about the kind of loads connected. See also:

► [Increase of reactive power due to harmonic currents](#)

TDD (Total Demand Distortion)

In the *APLUS* the complete harmonic content of the currents is shown as Total Demand Distortion, briefly TDD. This value is scaled to the rated current resp. rated power. Only this way it's possible to estimate the influence of the current harmonics on the connected equipment correctly.

Maximum values

The maximum values of the harmonic analysis arise from the monitoring of THD and TDD. The maximum values of individual harmonics are not monitored separately, but are stored if a maximum value of THD or TDD is detected. The image of the maximum harmonics therefore always corresponds to the dedicated THD resp. TDD.



The accuracy of the harmonic analysis depends strongly on the quality of the current and voltage transformers possibly used. In the harmonics range transformers normally change both, the amplitude and the phase of the signals to measure. It's valid: The higher the frequency of the harmonic, the higher its damping resp. phase shift.

A3 System imbalance

Measured quantity	present	max	min	1L	2L	3Lb	3Lu	3Lu.A	4Lb	4Lu.O	4Lu
UR1: Positive sequence [V]	•					√	√	√			√
UR2: Negative sequence [V]	•					√	√	√			√
U0: Zero sequence [V]	•										√
U: Imbalance UR2/UR1	•	•				√	√	√			√
U: Imbalance U0/UR1	•	•									√
IR1: Positive sequence [A]	•						√			√	√
IR2: Negative sequence [A]	•						√			√	√
I0: Zero sequence [A]	•						√			√	√
I: Imbalance IR2/IR1	•	•					√			√	√
I: Imbalance I0/IR1	•	•					√			√	√

 Available via interface only

Imbalance in three-phase systems may occur due to single-phase loads, but also due to failures, such as e.g. the blowing of a fuse, an earth fault, a phase failure or an isolation defect. Also harmonics of the 3rd, 9th, 15th, 21st etc. order, which add in the neutral wire, may lead to imbalance. Operating resources dimensioned to rated values, such as three-phase generators, transformers or motors on load side, may be excessively stressed by imbalance. So a shorter life cycle, a damage or failure due to thermal stress can result. Therefore monitoring imbalance helps to reduce the costs for maintenance and extends the undisturbed operating time of the used resources.

Imbalance or unbalanced load relays use different measurement principles. One of them is the approach of the symmetrical components, the other one calculates the maximum deviation from the mean-value of the three phase values. The results of these methods are not equal and don't have the same intention. Both of these principles are implemented in the *APLUS*.

Symmetrical components (acc. Fortescue)

The imbalance calculation method by means of the symmetrical components is ambitious and intensive to calculate. The results may be used for disturbance analysis and for protection purposes in three-phase systems. The real existing system is divided in symmetrical system parts: A positive sequence, a negative sequence and (for systems with neutral conductor) a zero sequence system. The approach is easiest to understand for rotating machines. The positive sequence represents a positive rotating field, the negative sequence a negative (braking) rotating field with opposite sense of direction. Therefore the negative sequence prevents that the machine can generate the full turning moment. For e.g. generators the maximum permissible current imbalance is typically limited to a value of 8...12%.

Maximum deviation from the mean value

The calculation of the maximum deviation from the mean value of the phase currents resp. phase voltages gives the information if a grid or substation is imbalanced loaded. The results are independent of rated values and the present load situation. So a more symmetrical system can be aspired, e.g. by changing loads from one phase to another.

Also failure detection is possible. The capacitors used in compensation systems are wear parts, which fail quite often and then have to be replaced. When using three phase power capacitors all phases will be compensated equally which leads to almost identical currents flowing through the capacitors, if the system load is comparable. By monitoring the current imbalance it's then possible to estimate if a capacitor failure is present.

The maximum deviations are calculated in the same steps as the instantaneous values and therefore are arranged there ([see A1](#)).

A4 Reactive power

Measured quantity	pres.	max	min	1L	2L	3Lb	3Lu	3LuA	4Lb	4Lu.O	4Lu
Distortion reactive power D	•	•		√	√	√	√	√	√	√	√
Distortion reactive power D1	•	•			√					√	√
Distortion reactive power D2	•	•			√					√	√
Distortion reactive power D3	•	•								√	√
Fundamental reactive power QG	•	•		√	√	√	√	√	√	√	√
Fundamental reactive power QG1	•	•			√					√	√
Fundamental reactive power QG2	•	•			√					√	√
Fundamental reactive power QG3	•	•								√	√
cosφ of fundamental	•		•	√	√	√	√	√	√	√	√
cosφ of fundamental L1	•		•		√					√	√
cosφ of fundamental L2	•		•		√					√	√
cosφ of fundamental L3	•		•							√	√
cosφ of fundamental, incoming inductive			•	√	√	√	√	√	√	√	√
cosφ of fundamental, incoming capacitive			•	√	√	√	√	√	√	√	√
cosφ of fundamental, outgoing inductive			•	√	√	√	√	√	√	√	√
cosφ of fundamental, outgoing capacitive			•	√	√	√	√	√	√	√	√
tanφ of fundamental	•			√	√	√	√	√	√	√	√
tanφ of fundamental L1	•				√					√	√
tanφ of fundamental L2	•				√					√	√
tanφ of fundamental L3	•									√	√

Available via interface only

Most of the loads consume a combination of ohmic and inductive current from the power system. Reactive power arises by means of the inductive load. But the number of non-linear loads, such as RPM regulated drives, rectifiers, thyristor controlled systems or fluorescent lamps, is increasing. They cause non-sinusoidal AC currents, which may be represented as a sum of harmonics. Thus the reactive power to transmit increases and leads to higher transmission losses and higher energy costs. This part of the reactive power is called distortion reactive power.

Normally reactive power is unwanted, because there is no usable active component in it. Because the transmission of reactive power over long distances is uneconomic, it makes sense to install compensation systems close to the consumers. So transmission capacities may be used better and losses and voltage drops by means of harmonic currents can be avoided.

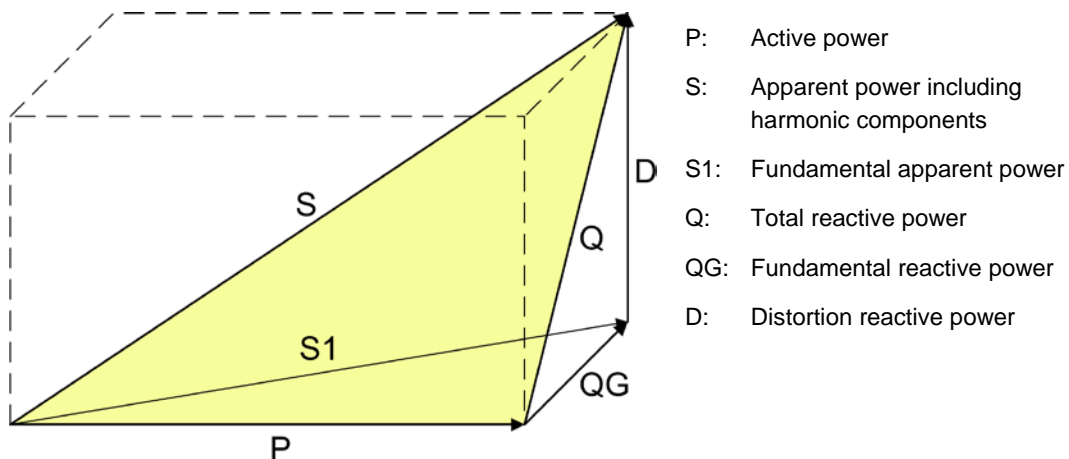

The reactive power may be divided in a fundamental and a distortion component. Only the fundamental reactive power may be compensated directly by means of the classical capacitive method. The distortion components have to be combated using inductors or active harmonic conditioners.

The *APLUS* reports a **load factor PF** which is the relation between active power P and apparent power S , including all possibly existing harmonic parts. This factor is often called $\cos\varphi$, which is only partly correct. The PF corresponds to the **cos φ** only, if there is no harmonic content present in the system. So the $\cos\varphi$ represents the relation between the active power P and the fundamental apparent power S_1 .

Also calculated is the **tan φ** , which is especially known as a target quantity for the reactive power compensative using capacitors. It corresponds to the relation of the fundamental reactive power Q_G and the active power P . Here intentionally the fundamental reactive power is used for the calculation, because this is the only component which may be directly compensated via capacitors.

A5 Mean values and trend

Measured quantity	Present	Trend	max	min	History
Active power incoming 1s...60min. ¹⁾	•	•	•	•	5
Active power outgoing 1s...60min. ¹⁾	•	•	•	•	5
Reactive power incoming 1s...60min. ¹⁾	•	•	•	•	5
Reactive power outgoing 1s...60min. ¹⁾	•	•	•	•	5
Reactive power inductive 1s...60min. ¹⁾	•	•	•	•	5
Reactive power capacitive 1s...60min. ¹⁾	•	•	•	•	5
Apparent power 1s...60min. ¹⁾	•	•	•	•	5
Mean value quantity 1 1s...60min. ²⁾	•	•	•	•	1
Mean value quantity 2 1s...60min. ²⁾	•	•	•	•	1
Mean value quantity 3 1s...60min. ²⁾	•	•	•	•	1
Mean value quantity 4 1s...60min. ²⁾	•	•	•	•	1
Mean value quantity 5 1s...60min. ²⁾	•	•	•	•	1
Mean value quantity 6 1s...60min. ²⁾	•	•	•	•	1
Mean value quantity 7 1s...60min. ²⁾	•	•	•	•	1
Mean value quantity 8 1s...60min. ²⁾	•	•	•	•	1
Mean value quantity 9 1s...60min. ²⁾	•	•	•	•	1
Mean value quantity 10 1s...60min. ²⁾	•	•	•	•	1
Mean value quantity 11 1s...60min. ²⁾	•	•	•	•	1
Mean value quantity 12 1s...60min. ²⁾	•	•	•	•	1

Available via interface only ¹⁾ Interval time t1 ²⁾ Interval time t2

The device calculates automatically the mean values of all system power quantities. In addition up to 12 further mean value quantities can be freely selected.

Calculating the mean-values

The mean value calculation is performed via integration of the measured instantaneous values over a configurable averaging interval. The interval time may be selected in the range from one second up to one hour. Possible interim values are set the way that a multiple of it is equal to a minute or an hour. Mean values of power quantities (interval time t1) and free quantities (interval time t2) may have different averaging intervals.

Synchronization

For the synchronization of the averaging intervals the internal clock or an external signal via digital input may be used. In case of an external synchronization the interval should be within the given range of one second up to one hour. The synchronization is important for making e.g. the mean value of power quantities on generating and demand side comparable.

Trend

The estimated final value (trend) of mean values is determined by weighted addition of measurements of the past and the present interval. It serves for early detection of a possible exceeding of a given maximum value. This can then be avoided, e.g. by switching off an active load.

History

For mean values of system powers the last 5 interval values may be displayed on the device or read via interface. For configurable quantities the value of the last interval is provided via communication interface.

A6 Meters

Measured quantity	1L	2L	3Lb	3Lu	3Lu.A	4Lb	4Lu.O	4Lu
Active energy incoming, high tariff	•	•	•	•	•	•	•	•
Active energy outgoing, high tariff	•	•	•	•	•	•	•	•
Reactive energy inductive, high tariff	•	•	•	•	•	•	•	•
Reactive energy capacitive, high tariff	•	•	•	•	•	•	•	•
Reactive energy incoming, high tariff	•	•	•	•	•	•	•	•
Reactive energy outgoing, high tariff	•	•	•	•	•	•	•	•
Active energy incoming, low tariff	•	•	•	•	•	•	•	•
Active energy outgoing, low tariff	•	•	•	•	•	•	•	•
Reactive energy inductive, low tariff	•	•	•	•	•	•	•	•
Reactive energy capacitive, low tariff	•	•	•	•	•	•	•	•
Reactive energy incoming, low tariff	•	•	•	•	•	•	•	•
Reactive energy outgoing, low tariff	•	•	•	•	•	•	•	•
Active energy incoming L1, high tariff		•					•	•
Active energy incoming L2, high tariff		•					•	•
Active energy incoming L3, high tariff							•	•
Reactive energy incoming L1, high tariff		•					•	•
Reactive energy incoming L2, high tariff		•					•	•
Reactive energy incoming L3, high tariff							•	•
Active energy incoming L1, low tariff		•					•	•
Active energy incoming L2, low tariff		•					•	•
Active energy incoming L3, low tariff							•	•
Reactive energy incoming L1, low tariff		•					•	•
Reactive energy incoming L2, low tariff		•					•	•
Reactive energy incoming L3, low tariff							•	•
Meter I/O 2, high tariff	Independent of measured system							
Meter I/O 6, high tariff								
Meter I/O 7, high tariff								
Meter I/O 8, high tariff								
Meter I/O 9, high tariff								
Meter I/O 10, high tariff								
Meter I/O 11, high tariff								
Meter I/O 2, low tariff								
Meter I/O 6, low tariff								
Meter I/O 7, low tariff								
Meter I/O 8, low tariff								
Meter I/O 9, low tariff								
Meter I/O 10, low tariff								
Meter I/O 11, low tariff								

Standard meters

The meters for active and reactive energy of the system are always active. The meters for active and reactive energy demand per phase are active only, if the measured system is a multiple phase system with unbalanced load, otherwise they are removed from the above list.

► [Meter reading on the display](#)

I/O meters

The meters of the I/O's are available only if the appropriate I/O's are configured as digital inputs for pulse counting, otherwise they are removed from the above list. No specific unit is shown for this kind of meters, because any energy form may be recorded here.

B Display matrices in FULL mode

The fourth line of each image is allocated to a programmable meter value, which does not change even if another measurement image is selected. In the subsequent matrices, arranged in accordance with the measured system, this fourth line is not included.

B0 Used abbreviations for the measurements

No.	Name	Description	Name (Display)
0	---	not used	---
1	U	Voltage system in single, 3- or 4-wire systems	<i>U</i>
2	U1N	Voltage between phase L1 and neutral	<i>U 1n</i>
3	U2N	Voltage between phase L2 and neutral	<i>U 2n</i>
4	U3N	Voltage between phase L3 and neutral	<i>U 3n</i>
5	U12	Voltage between phases L1 and L2	<i>U 12</i>
6	U23	Voltage between phases L2 and L3	<i>U 23</i>
7	U31	Voltage between phases L3 and L1	<i>U 31</i>
8	UNE	Zero displacement voltage 4-wire systems	<i>U nE</i>
9	I	Current system in single, 3- or 4-wire systems	<i>I</i>
10	I1	Current phase L1	<i>I 1</i>
11	I2	Current phase L2	<i>I 2</i>
12	I3	Current phase L3	<i>I 3</i>
13	IN	Neutral current	<i>I n</i>
14	IB	Current damped, balanced system (bimetal)	<i>I b</i>
15	IB1	Current damped phase L1 (bimetal)	<i>I b 1</i>
16	IB2	Current damped phase L2 (bimetal)	<i>I b 2</i>
17	IB3	Current damped phase L3 (bimetal)	<i>I b 3</i>
18	P	Active power system ($P=P1+P2+P3$)	<i>P</i>
19	P1	Active power phase L1	<i>P 1</i>
20	P2	Active power phase L2	<i>P 2</i>
21	P3	Active power phase L3	<i>P 3</i>
22	Q	Reactive power system ($Q=Q1+Q2+Q3$)	<i>q</i>
23	Q1	Reactive power phase L1	<i>q 1</i>
24	Q2	Reactive power phase L2	<i>q 2</i>
25	Q3	Reactive power phase L3	<i>q 3</i>
26	S	Apparent power system	<i>S</i>
27	S1	Apparent power phase L1	<i>S 1</i>
28	S2	Apparent power phase L2	<i>S 2</i>
29	S3	Apparent power phase L3	<i>S 3</i>
30	F	System frequency	<i>F</i>
31	PF	Active power factor P/S, system	<i>PF</i>
32	PF1	Active power factor P1/S1, phase 1	<i>PF 1</i>
33	PF2	Active power factor P2/S2, phase 2	<i>PF 2</i>
34	PF3	Active power factor P3/S3, phase 3	<i>PF 3</i>
35	QF	Reactive power factor P/S, system	<i>qF</i>
36	QF1	Reactive power factor P1/S1, phase 1	<i>qF 1</i>
37	QF2	Reactive power factor P2/S2, phase 2	<i>qF 2</i>
38	QF3	Reactive power factor P3/S3, phase 3	<i>qF 3</i>
39	LF	Load factor system, $\text{sign}(Q) \times (1 - \text{abs}(PF))$	<i>LF</i>
40	LF1	Load factor phase L1	<i>LF 1</i>
41	LF2	Load factor phase L2	<i>LF 2</i>
42	LF3	Load factor phase L3	<i>LF 3</i>
43	U_MEAN	Average voltage $(U1N+U2N+U3N)/3$	<i>U MEAN</i>
44	I_MEAN	Average current $(I1+I2+I3)/3$	<i>I MEAN</i>
45	UF12	Phase angle U1-U2	<i>RU 12</i>
46	UF23	Phase angle U2-U3	<i>RU 23</i>

No.	Name	Description	Name (Display)
47	UF31	Phase angle U3-U1	$\angle U_3 U_1$
48	DEV_UMAX	Max. deviation from average of voltages	dE_{uU}
49	DEV_IMAX	Max. deviation from average of currents	dE_{iI}
50	DEV_U1	U1: deviation from average of voltages	dE_{uU}
51	DEV_U2	U2: deviation from average of voltages	dE_{uU}
52	DEV_U3	U3: deviation from average of voltages	dE_{uU}
53	DEV_I1	I1: deviation from average of currents	dE_{iI}
54	DEV_I2	I2: deviation from average of currents	dE_{iI}
55	DEV_I3	I3: deviation from average of currents	dE_{iI}
56	U_MAX	Maximum value of U	U
57	U1N_MAX	Maximum value of U1N	U_{1n}
58	U2N_MAX	Maximum value of U2N	U_{2n}
59	U3N_MAX	Maximum value of U3N	U_{3n}
60	U12_MAX	Maximum value of U12	U_{12}
61	U23_MAX	Maximum value of U23	U_{23}
62	U31_MAX	Maximum value of U31	U_{31}
63	UNE_MAX	Maximum value of UNE	U_{nE}
64	I_MAX	Maximum value of I	I
65	I1_MAX	Maximum value of I1	I_1
66	I2_MAX	Maximum value of I2	I_2
67	I3_MAX	Maximum value of I3	I_3
68	IN_MAX	Maximum value of IN	I_n
69	IB_MAX	Maximum value of IB	I_b
70	IB1_MAX	Maximum value of IB1	I_{b1}
71	IB2_MAX	Maximum value of IB2	I_{b2}
72	IB3_MAX	Maximum value of IB3	I_{b3}
73	P_MAX	Maximum value of P	P
74	P1_MAX	Maximum value of P1	P_1
75	P2_MAX	Maximum value of P2	P_2
76	P3_MAX	Maximum value of P3	P_3
77	Q_MAX	Maximum value of Q	Q
78	Q1_MAX	Maximum value of Q1	Q_1
79	Q2_MAX	Maximum value of Q2	Q_2
80	Q3_MAX	Maximum value of Q3	Q_3
81	S_MAX	Maximum value of S	S
82	S1_MAX	Maximum value of S1	S_1
83	S2_MAX	Maximum value of S2	S_2
84	S3_MAX	Maximum value of S3	S_3
85	F_MAX	Maximum value of F	F
86	DEV_UMAX_MAX	Maximum value of DEV_UMAX	dE_{uU}
87	DEV_IMAX_MAX	Maximum value of DEV_IMAX	dE_{iI}
88	U_MIN	Minimum value of U	U
89	U1N_MIN	Minimum value of U1N	U_{1n}
90	U2N_MIN	Minimum value of U2N	U_{2n}
91	U3N_MIN	Minimum value of U3N	U_{3n}
92	U12_MIN	Minimum value of U12	U_{12}
93	U23_MIN	Minimum value of U23	U_{23}
94	U31_MIN	Minimum value of U31	U_{31}
95	PF_MIN_IN_L	Minimum active power factor, incoming/inductive	PF_{iL}
96	PF_MIN_IN_C	Minimum active power factor, incoming/capacitive	PF_{iC}
97	PF_MIN_OUT_L	Minimum active power factor, outgoing/inductive	PF_{oL}
98	PF_MIN_OUT_C	Minimum active power factor, outgoing/capacitive	PF_{oC}
99	F_MIN	Minimum value of f	F
100	PIN	P incoming	P_{in}

No.	Name	Description	Name (Display)
101	P1IN	P1 incoming	P_{in1}
102	P2IN	P2 incoming	P_{in2}
103	P3IN	P3 incoming	P_{in3}
104	POUT	P outgoing	P_{out}
105	P1OUT	P1 outgoing	P_{out}
106	P2OUT	P2 outgoing	P_{out}
107	P3OUT	P3 outgoing	P_{out}
108	PIN_OUT	P incoming-outgoing	P_{in0}
109	P1IN_OUT	P1 incoming-outgoing	P_{in0}
110	P2IN_OUT	P2 incoming-outgoing	P_{in0}
111	P3IN_OUT	P3 incoming-outgoing	P_{in0}
112	QIND	Q inductive	Q_{ind}
113	Q1IND	Q1 inductive	Q_{ind}
114	Q2IND	Q2 inductive	Q_{ind}
115	Q3IND	Q3 inductive	Q_{ind}
116	QCAP	Q capacitive	Q_{cAP}
117	Q1CAP	Q1 capacitive	Q_{cAP}
118	Q2CAP	Q2 capacitive	Q_{cAP}
119	Q3CAP	Q3 capacitive	Q_{cAP}
120	QIN	Q incoming	Q_{in}
121	Q1IN	Q1 incoming	Q_{in}
122	Q2IN	Q2 incoming	Q_{in}
123	Q3IN	Q3 incoming	Q_{in}
124	QOUT	Q outgoing	Q_{out}
125	Q1OUT	Q1 outgoing	Q_{out}
126	Q2OUT	Q2 outgoing	Q_{out}
127	Q3OUT	Q3 outgoing	Q_{out}
128	QIN_OUT	Q incoming-outgoing	Q_{in0}
129	Q1IN_OUT	Q1 incoming-outgoing	Q_{in0}
130	Q2IN_OUT	Q2 incoming-outgoing	Q_{in0}
131	Q3IN_OUT	Q3 incoming-outgoing	Q_{in0}
132	UR1	Positive sequence voltage	U_{r1}
133	UR2	Negative sequence voltage	U_{r2}
134	U0	Zero sequence voltage	U_0
135	IR1	Positive sequence current	I_{r1}
136	IR2	Negative sequence current	I_{r2}
137	I0	Zero sequence current	I_0
138	UNB_UR2_UR1	Unbalance factor voltage UR2/UR1	U_{r21}
139	UNB_IR2_IR1	Unbalance factor current IR2/IR1	I_{r21}
140	UNB_U0_UR1	Unbalance factor voltage U0/UR1	U_{r01}
141	UNB_I0_IR1	Unbalance factor current I0/IR1	I_{r01}
142	THD_U	Total Harmonic Distortion of U	t_{hdU}
143	THD_U1N	Total Harmonic Distortion of U1N	t_{hdU}
144	THD_U2N	Total Harmonic Distortion of U2N	t_{hdU}
145	THD_U3N	Total Harmonic Distortion of U3N	t_{hdU}
146	THD_U12	Total Harmonic Distortion of U12	t_{hdU}
147	THD_U23	Total Harmonic Distortion of U23	t_{hdU}
148	THD_U31	Total Harmonic Distortion of U31	t_{hdU}
149	TDD_I	Total Demand Distortion of I	t_{ddI}
150	TDD_I1	Total Demand Distortion of I1	t_{ddI}
151	TDD_I2	Total Demand Distortion of I2	t_{ddI}
152	TDD_I3	Total Demand Distortion of I3	t_{ddI}
153	D	Distortion reactive power system	d
154	D1	Distortion reactive power phase L1	$d1$

No.	Name	Description	Name (Display)
155	D2	Distortion reactive power phase L2	$d2$
156	D3	Distortion reactive power phase L3	$d3$
157	QG	Reactive power fundamental system	q_{HI}
158	QG1	Reactive power fundamental phase L1	q_{HI}
159	QG2	Reactive power fundamental phase L2	q_{HI}
160	QG3	Reactive power fundamental phase L3	q_{HI}
161	PFG	cos(ϕ) of fundamental system	cPh_i
162	PFG1	cos(ϕ) of fundamental phase L1	cPh_i
163	PFG2	cos(ϕ) of fundamental phase L2	cPh_i
164	PFG3	cos(ϕ) of fundamental phase L3	cPh_i
161	TG	tan(ϕ) of fundamental system	tPh_i
162	TG1	tan(ϕ) of fundamental phase L1	tPh_i
163	TG2	tan(ϕ) of fundamental phase L2	tPh_i
164	TG3	tan(ϕ) of fundamental phase L3	tPh_i
169	UNB_UR2_UR1_MAX	Max. unbalance factor voltage UR2/UR1	$Ur2I$
170	UNB_IR2_IR1_MAX	Max. unbalance factor current IR2/IR1	$Ir2I$
171	UNB_U0_UR1_MAX	Max. unbalance factor voltage U0/UR1	$Ur0I$
172	UNB_I0_IR1_MAX	Max. unbalance factor current I0/IR1	$Ir0I$
173	THD_U_MAX	Max. Total Harmonic Distortion of U	$tHdU$
174	THD_U1N_MAX	Max. Total Harmonic Distortion of U1N	$tHdU$
175	THD_U2N_MAX	Max. Total Harmonic Distortion of U2N	$tHdU$
176	THD_U3N_MAX	Max. Total Harmonic Distortion of U3N	$tHdU$
177	THD_U12_MAX	Max. Total Harmonic Distortion of U12	$tHdU$
178	THD_U23_MAX	Total Harmonic Distortion of U23	$tHdU$
179	THD_U31_MAX	Max. Total Harmonic Distortion of U31	$tHdU$
180	TDD_I_MAX	Max. Total Demand Distortion of I	$tDdI$
181	TDD_I1_MAX	Max. Total Demand Distortion of I1	$tDdI$
182	TDD_I2_MAX	Max. Total Demand Distortion of I2	$tDdI$
183	TDD_I3_MAX	Max. Total Demand Distortion of I3	$tDdI$
184	D_MAX	Max. distortion reactive power system	d
185	D1_MAX	Max. distortion reactive power phase L1	dI
186	D2_MAX	Max. distortion reactive power phase L2	$d2$
187	D3_MAX	Max. distortion reactive power phase L3	$d3$
188	QG_MAX	Max. reactive power fundamental system	q_{HI}
189	QG1_MAX	Max. reactive power fundamental phase L1	q_{HI}
190	QG2_MAX	Max. reactive power fundamental phase L2	q_{HI}
191	QG3_MAX	Max. reactive power fundamental phase L3	q_{HI}
192	PFG_MIN_IN_L	Min. cos(ϕ) fundamental, incoming/inductive	cP_{iL}
193	PFG_MIN_IN_C	Min. cos(ϕ) fundamental, incoming/capacitive	cP_{iC}
194	PFG_MIN_OUT_L	Min. cos(ϕ) fundamental, outgoing/inductive	cP_{oL}
195	PFG_MIN_OUT_C	Min. cos(ϕ) fundamental, outgoing/capacitive	cP_{oC}
196	M1_PIN	Mean-value 1: P incoming (last interval)	P_{inc}
197	M2_PIN	Mean-value 2: P incoming (interval t-1)	P_{inc}
198	M3_PIN	Mean-value 3: P incoming (interval t-2)	P_{inc}
199	M4_PIN	Mean-value 4: P incoming (interval t-3)	P_{inc}
200	M5_PIN	Mean-value 5: P incoming (interval t-4)	P_{inc}
201	M1_POUT	Mean-value 1: P outgoing (last interval)	P_{out}
202	M2_POUT	Mean-value 2: P outgoing (interval t-1)	P_{out}
203	M3_POUT	Mean-value 3: P outgoing (interval t-2)	P_{out}
204	M4_POUT	Mean-value 4: P outgoing (interval t-3)	P_{out}
205	M5_POUT	Mean-value 5: P outgoing (interval t-4)	P_{out}
206	M1_QIN	Mean-value 1: Q incoming (last interval)	q_{inc}
207	M2_QIN	Mean-value 2: Q incoming (interval t-1)	q_{inc}
208	M3_QIN	Mean-value 3: Q incoming (interval t-2)	q_{inc}

No.	Name	Description	Name (Display)
209	M4_QIN	Mean-value 4: Q incoming (interval t-3)	Q inc
210	M5_QIN	Mean-value 5: Q incoming (interval t-4)	Q inc
211	M1_QCAP	Mean-value 1: Q capacitive (last interval)	Qc AP
212	M2_QCAP	Mean-value 2: Q capacitive (interval t-1)	Qc AP
213	M3_QCAP	Mean-value 3: Q capacitive (interval t-2)	Qc AP
214	M4_QCAP	Mean-value 4: Q capacitive (interval t-3)	Qc AP
215	M5_QCAP	Mean-value 5: Q capacitive (interval t-4)	Qc AP
216	M1_QIND	Mean-value 1: Q inductive (last interval)	Q ind
217	M2_QIND	Mean-value 2: Q inductive (interval t-1)	Q ind
218	M3_QIND	Mean-value 3: Q inductive (interval t-2)	Q ind
219	M4_QIND	Mean-value 4: Q inductive (interval t-3)	Q ind
220	M5_QIND	Mean-value 5: Q inductive (interval t-4)	Q ind
221	M1_QOUT	Mean-value 1: Q outgoing (last interval)	Qo Ut
222	M2_QOUT	Mean-value 2: Q outgoing (interval t-1)	Qo Ut
223	M3_QOUT	Mean-value 3: Q outgoing (interval t-2)	Qo Ut
224	M4_QOUT	Mean-value 4: Q outgoing (interval t-3)	Qo Ut
225	M5_QOUT	Mean-value 5: Q outgoing (interval t-4)	Qo Ut
226	M1_S	Mean-value 1: S (last interval)	S
227	M2_S	Mean-value 2: S (interval t-1)	S
228	M3_S	Mean-value 3: S (interval t-2)	S
229	M4_S	Mean-value 4: S (interval t-3)	S
230	M5_S	Mean-value 5: S (interval t-4)	S
231	TR_PIN	Trend mean-value P incoming	Tr.PI
232	TR_POUT	Trend mean-value P outgoing	Tr.PO
233	TR_QIND	Trend mean-value Q inductive	Tr.QL
234	TR_QCAP	Trend mean-value Q capacitive	Tr.QC
235	TR_QIN	Trend mean-value Q incoming	Tr.QI
236	TR_QOUT	Trend mean-value Q outgoing	Tr.QO
237	TR_S	Trend mean-value S	Tr.S
238	M_PIN_MIN	Maximum mean-value P incoming	P. inc
239	M_POUT_MIN	Maximum mean-value P outgoing	Po Ut
240	M_QIND_MIN	Maximum mean-value Q inductive	Q ind
241	M_QCAP_MIN	Maximum mean-value Q capacitive	Qc AP
242	M_QIN_MIN	Maximum mean-value Q incoming	Q inc
243	M_QOUT_MIN	Maximum mean-value Q outgoing	Qo Ut
244	M_S_MIN	Maximum mean-value S	S
245	M_PIN_MAX	Minimum mean-value P incoming	P. inc
246	M_POUT_MAX	Minimum mean-value P outgoing	Po Ut
247	M_QIND_MAX	Minimum mean-value Q inductive	Q ind
248	M_QCAP_MAX	Minimum mean-value Q capacitive	Qc AP
249	M_QIN_MAX	Minimum mean-value Q incoming	Q inc
250	M_QOUT_MAX	Minimum mean-value Q outgoing	Qo Ut
251	M_S_MAX	Minimum mean-value S	S
252	M1	Mean-value 1	ii 1
253	M2	Mean-value 2	ii 2
254	M3	Mean-value 3	ii 3
255	M4	Mean-value 4	ii 4
256	M5	Mean-value 5	ii 5
257	M6	Mean-value 6	ii 6
258	M7	Mean-value 7	ii 7
259	M8	Mean-value 8	ii 8
260	M9	Mean-value 9	ii 9
261	M10	Mean-value 10	ii 10
262	M11	Mean-value 11	ii 11

No.	Name	Description	Name (Display)
263	M12	Mean-value 12	$\bar{n} 12$
264	TR_1	Trend mean-value 1	$t_r 1$
265	TR_2	Trend mean-value 2	$t_r 2$
266	TR_3	Trend mean-value 3	$t_r 3$
267	TR_4	Trend mean-value 4	$t_r 4$
268	TR_5	Trend mean-value 5	$t_r 5$
269	TR_6	Trend mean-value 6	$t_r 6$
270	TR_7	Trend mean-value 7	$t_r 7$
271	TR_8	Trend mean-value 8	$t_r 8$
272	TR_9	Trend mean-value 9	$t_r 9$
273	TR_10	Trend mean-value 10	$t_r 10$
274	TR_11	Trend mean-value 11	$t_r 11$
275	TR_12	Trend mean-value 12	$t_r 12$
276	M1_MIN	Maximum mean-value 1	$\bar{n} 1$
277	M2_MIN	Maximum mean-value 2	$\bar{n} 2$
278	M3_MIN	Maximum mean-value 3	$\bar{n} 3$
279	M4_MIN	Maximum mean-value 4	$\bar{n} 4$
280	M5_MIN	Maximum mean-value 5	$\bar{n} 5$
281	M6_MIN	Maximum mean-value 6	$\bar{n} 6$
282	M7_MIN	Maximum mean-value 7	$\bar{n} 7$
283	M8_MIN	Maximum mean-value 8	$\bar{n} 8$
284	M9_MIN	Maximum mean-value 9	$\bar{n} 9$
285	M10_MIN	Maximum mean-value 10	$\bar{n} 10$
286	M11_MIN	Maximum mean-value 11	$\bar{n} 11$
287	M12_MIN	Maximum mean-value 12	$\bar{n} 12$
288	M1_MAX	Minimum mean-value 1	$\bar{n} 1$
289	M2_MAX	Minimum mean-value 2	$\bar{n} 2$
290	M3_MAX	Minimum mean-value 3	$\bar{n} 3$
291	M4_MAX	Minimum mean-value 4	$\bar{n} 4$
292	M5_MAX	Minimum mean-value 5	$\bar{n} 5$
293	M6_MAX	Minimum mean-value 6	$\bar{n} 6$
294	M7_MAX	Minimum mean-value 7	$\bar{n} 7$
295	M8_MAX	Minimum mean-value 8	$\bar{n} 8$
296	M9_MAX	Minimum mean-value 9	$\bar{n} 9$
297	M10_MAX	Minimum mean-value 10	$\bar{n} 10$
298	M11_MAX	Minimum mean-value 11	$\bar{n} 11$
299	M12_MAX	Minimum mean-value 12	$\bar{n} 12$
300	AOUT1	Analog output 1	$A01$
301	AOUT2	Analog output 2	$A02$
302	AOUT3	Analog output 3	$A03$
303	AOUT4	Analog output 4	$A04$
304	PIN_HT	Meter P incoming high tariff	$P1.Ht$
305	POUT_HT	Meter P outgoing high tariff	$P0.Ht$
306	QIND_HT	Meter Q inductive high tariff	$Q.L.Ht$
307	QCAP_HT	Meter Q capacitive high tariff	$Q.C.Ht$
308	QIN_HT	Meter Q incoming high tariff	$Q1.Ht$
309	QOUT_HT	Meter Q outgoing high tariff	$Q0.Ht$
310	PIN_LT	Meter P incoming low tariff	$P1.Lt$
311	POUT_LT	Meter P outgoing low tariff	$P0.Lt$
312	QIND_LT	Meter Q inductive low tariff	$Q.L.Lt$
313	QCAP_LT	Meter Q capacitive low tariff	$Q.C.Lt$
314	QIN_LT	Meter Q incoming low tariff	$Q1.Lt$
315	QOUT_LT	Meter Q outgoing low tariff	$Q0.Lt$
316	P1IN_HT	Meter P1 incoming high tariff	$P11.H$

No.	Name	Description	Name (Display)
317	P2IN_HT	Meter P2 incoming high tariff	P2I.H
318	P3IN_HT	Meter P3 incoming high tariff	P3I.H
319	Q1IN_HT	Meter Q1 incoming high tariff	Q1I.H
320	Q2IN_HT	Meter Q2 incoming high tariff	Q2I.H
321	Q3IN_HT	Meter Q3 incoming high tariff	Q3I.H
322	P1IN_LT	Meter P1 incoming low tariff	P1I.L
323	P2IN_LT	Meter P2 incoming low tariff	P2I.L
324	P3IN_LT	Meter P3 incoming low tariff	P3I.L
325	Q1IN_LT	Meter Q1 incoming low tariff	Q1I.L
326	Q2IN_LT	Meter Q2 incoming low tariff	Q2I.L
327	Q3IN_LT	Meter Q3 incoming low tariff	Q3I.L
328	CNTR_IO2_HT	Meter I/O 2 high tariff	E 2H
329	CNTR_IO6_HT	Meter I/O 6 high tariff	E 6H
330	CNTR_IO7_HT	Meter I/O 7 high tariff	E 7H
331	CNTR_IO8_HT	Meter I/O 8 high tariff	E 8H
332	CNTR_IO9_HT	Meter I/O 9 high tariff	E 9H
333	CNTR_IO10_HT	Meter I/O 10 high tariff	E 10H
334	CNTR_IO11_HT	Meter I/O 11 high tariff	E 11H
335	CNTR_IO2_LT	Meter I/O 2 low tariff	E 2L
336	CNTR_IO6_LT	Meter I/O 6 low tariff	E 6L
337	CNTR_IO7_LT	Meter I/O 7 low tariff	E 7L
352	CNTR_IO8_LT	Meter I/O 8 low tariff	E 8L
353	CNTR_IO9_LT	Meter I/O 9 low tariff	E 9L
354	CNTR_IO10_LT	Meter I/O 10 low tariff	E 10L
355	CNTR_IO11_LT	Meter I/O 11 low tariff	E 11L
356	RTC.UTC	UTC time in seconds since January 1st 1970	UTCt
357	EV_TIME	UTC time of last event	EJtE
358	OPR_CNTR	Operating hour counter APLUS	OE C
359	OPR_CNTR1	Resettable operating hour counter 1	OE C 1
360	OPR_CNTR2	Resettable operating hour counter 2	OE C 2
361	OPR_CNTR3	Resettable operating hour counter 3	OE C 3
362	RTC_LOCAL	Local time in seconds since January 1st 1970	LOCt
363	H2_U1X	Voltage phase 1: content of 2nd harmonic	
	:	:	
424	H63_U1X	Voltage phase 1: content of 63rd harmonic	
425	H2_U2X	Voltage phase 2: content of 2nd harmonic	
	:	:	
486	H63_U2X	Voltage phase 2: content of 63rd harmonic	
487	H2_U3X	Voltage phase 3: content of 2nd harmonic	
	:	:	
548	H63_U3X	Voltage phase 3: content of 63rd harmonic	
549	H2_I1X	Current phase 1: content of 2nd harmonic	
	:	:	
610	H63_I1X	Current phase 1: content of 63rd harmonic	
611	H2_I2X	Current phase 2: content of 2nd harmonic	
	:	:	
672	H63_I2X	Current phase 2: content of 63rd harmonic	
673	H2_I3X	Current phase 3: content of 2nd harmonic	
	:	:	
734	H63_I3X	Current phase 3: content of 63rd harmonic	
735	H2_U1X_MAX	Voltage phase 1: max. content of 2nd harmonic	
	:	:	
796	H63_U1X_MAX	Voltage phase 1: max. content of 63rd harmonic	
797	H2_U2X_MAX	Voltage phase 2: max. content of 2nd harmonic	
	:	:	
858	H63_U2X_MAX	Voltage phase 2: max. content of 63rd harmonic	

No.	Name	Description	Name (Display)
859	H2_U3X_MAX	Voltage phase 3: max. content of 2nd harmonic	
920	H63_U3X_MAX	Voltage phase 3: max. content of 63rd harmonic	
921	H2_I1X_MAX	Current phase 1: max. content of 2nd harmonic	
982	H63_I1X_MAX	Current phase 1: max. content of 63rd harmonic	
983	H2_I2X_MAX	Current phase 2: max. content of 2nd harmonic	
1044	H63_I2X_MAX	Current phase 2: max. content of 63rd harmonic	
1045	H2_I3X_MAX	Current phase 3: max. content of 2nd harmonic	
1106	H63_I3X_MAX	Current phase 3: max. content of 63rd harmonic	

B1 Display matrix single phase system

U_MAX						
U						
U_MIN						
I	IB					
I_MAX	IB_MAX					
P						
P_MAX						
Q						
Q_MAX						
S						
S_MAX						
PF	PF	PFG	PFG			
PF_MIN_IN_L	PF_MIN_OUT_L	PFG_MIN_IN_L	PFG_MIN_OUT_L			
PF_MIN_IN_C	PF_MIN_OUT_C	PFG_MIN_IN_C	PFG_MIN_OUT_C			
F_MAX						
F						
F_MIN						
P	P	P	P	P		
Q	U	Q	S	QG		
S	I	PF	F	TG		
D	QG					
D_MAX	QG_MAX					
dd.mm	OPR_CNTR1	OPR_CNTR				
hh.mm	OPR_CNTR2					
ss	OPR_CNTR3					
THD_U						
THD_U_MAX						
TDD_I						
TDD_I_MAX						
Block with mean values of power quantities						
H2_U	H3_U	H4_U	...	H48_U	H49_U	H50_U
H2_U_MAX	H3_U_MAX	H4_U_MAX		H48_U_MAX	H49_U_MAX	H50_U_MAX
H2_I	H3_I	H4_I	...	H48_I	H49_I	H50_I
H2_I_MAX	H3_I_MAX	H4_I_MAX		H48_I_MAX	H49_I_MAX	H50_I_MAX

B2 Display matrix Split-phase (two-phase) systems

U1N U2N U	U1N_MAX U2N_MAX U_MAX	U1N_MIN U2N_MIN U_MIN	UNE UNE_MAX			
I1 I2	I1_MAX I2_MAX	IB1 IB2	IB1_MAX IB2_MAX			
P1 P2 P	P1_MAX P2_MAX P_MAX					
Q1 Q2 Q	Q1_MAX Q2_MAX Q_MAX					
S1 S2 S	S1_MAX S2_MAX S_MAX					
PF PF1 PF2	PF PF_MIN_IN_L PF_MIN_IN_C					PF PF_MIN_OUT_L PF_MIN_OUT_C
F_MAX F F_MIN						
P Q S	P U_MEAN I_MEAN	P Q PF	P S F	P QG TG		
P1 Q1 S1	P2 Q2 S2	U1N I1 P1	U2N I2 P2			
D1 D2	D1_MAX D2_MAX	D D_MAX	QG1 QG2	QG1_MAX QG2_MAX	QG QG_MAX	
dd.mm hh.mm ss	OPR_CNTR1 OPR_CNTR2 OPR_CNTR3	OPR_CNTR				
THD_U1N THD_U1N_MAX	THD_U2N THD_U2N_MAX					
TDD_I1 TDD_I1_MAX	TDD_I2 TDD_I2_MAX					
Block with mean values of power quantities						
H2_U1N H2_U1N_MAX	H3_U1N H3_U1N_MAX	H4_U1N H4_U1N_MAX	...	H48_U1N H48_U1N_MAX	H49_U1N H49_U1N_MAX	H50_U1N H50_U1N_MAX
H2_U2N H2_U2N_MAX	H3_U2N H3_U2N_MAX	H4_U2N H4_U2N_MAX	...	H48_U2N H48_U2N_MAX	H49_U2N H49_U2N_MAX	H50_U2N H50_U2N_MAX
H2_I1 H2_I1_MAX	H3_I1 H3_I1_MAX	H4_I1 H4_I1_MAX	...	H48_I1 H48_I1_MAX	H49_I1 H49_I1_MAX	H50_I1 H50_I1_MAX
H2_I2 H2_I2_MAX	H3_I2 H3_I2_MAX	H4_I2 H4_I2_MAX	...	H48_I2 H48_I2_MAX	H49_I2 H49_I2_MAX	H50_I2 H50_I2_MAX

B3 Display matrix 3-wire system, balanced load

U12 U23 U31	U12_MAX U23_MAX U31_MAX	U12_MIN U23_MIN U31_MIN	DEV_UMAX DEV_UMAX_MAX
UR1 UR2 U0	UNB_UR2_UR1 UNB_UR2_UR1_MAX		
I I_MAX	IB IB_MAX		
P P_MAX			
Q Q_MAX			
S S_MAX			
PF PF_MIN_IN_L PF_MIN_IN_C	PF PF_MIN_OUT_L PF_MIN_OUT_C	PFG PFG_MIN_IN_L PFG_MIN_IN_C	PFG PFG_MIN_OUT_L PFG_MIN_OUT_C
F_MAX F F_MIN			
P Q S	P Q PF	P S F	P QG TG
D D_MAX	QG QG_MAX		
dd.mm hh.mm ss	OPR_CNTR1 OPR_CNTR2 OPR_CNTR3	OPR_CNTR	
THD_U12 THD_U12_MAX	THD_U23 THD_U23_MAX	THD_U31 THD_U31_MAX	
TDD_I TDD_I_MAX			

Block with mean-values of power quantities						
H2_U12 H2_U12_MAX	H3_U12 H3_U12_MAX	H4_U12 H4_U12_MAX	...	H48_U12 H48_U12_MAX	H49_U12 H49_U12_MAX	H50_U12 H50_U12_MAX
H2_U23 H2_U23_MAX	H3_U23 H3_U23_MAX	H4_U23 H4_U23_MAX	...	H48_U23 H48_U23_MAX	H49_U23 H49_U23_MAX	H50_U23 H50_U23_MAX
H2_U31 H2_U31_MAX	H3_U31 H3_U31_MAX	H4_U31 H4_U31_MAX	...	H48_U31 H48_U31_MAX	H49_U31 H49_U31_MAX	H50_U31 H50_U31_MAX
H2_I H2_I_MAX	H3_I H3_I_MAX	H4_I H4_I_MAX	...	H48_I H48_I_MAX	H49_I H49_I_MAX	H50_I H50_I_MAX

B4 Display matrix 3-wire systems, unbalanced load

U12 U23 U31	U12_MAX U23_MAX U31_MAX	U12_MIN U23_MIN U31_MIN	DEV_UMAX DEV_UMAX_MAX			
UR1 UR2 U0	UNB_UR2_UR1 UNB_UR2_UR1_MAX					
I1 I2 I3	I1_MAX I2_MAX I3_MAX	IB1 IB2 IB3	IB1_MAX IB2_MAX IB3_MAX	DEV_IMAX DEV_IMAX_MAX		
IR1 IR2 I0	UNB_IR2_IR1 UNB_IR2_IR1_MAX					
P P_MAX						
Q Q_MAX						
S S_MAX						
PF PF_MIN_IN_L PF_MIN_IN_C	PF PF_MIN_OUT_L PF_MIN_OUT_C	PFG PFG_MIN_IN_L PFG_MIN_IN_C	PFG PFG_MIN_OUT_L PFG_MIN_OUT_C			
F_MAX F F_MIN						
P Q S	P U_MEAN I_MEAN	P Q PF	P S F	P QG TG		
D D_MAX	QG QG_MAX					
dd.mm hh.mm ss	OPR_CNTR1 OPR_CNTR2 OPR_CNTR3	OPR_CNTR				
THD_U12 THD_U12_MAX	THD_U23 THD_U23_MAX	THD_U31 THD_U31_MAX				
TDD_I1 TDD_I1_MAX	TDD_I2 TDD_I2_MAX	TDD_I3 TDD_I3_MAX				
Block with mean-values of power quantities						
H2_U12 H2_U12_MAX	H3_U12 H3_U12_MAX	H4_U12 H4_U12_MAX	...	H48_U12 H48_U12_MAX	H49_U12 H49_U12_MAX	H50_U12 H50_U12_MAX
H2_U23 H2_U23_MAX	H3_U23 H3_U23_MAX	H4_U23 H4_U23_MAX	...	H48_U23 H48_U23_MAX	H49_U23 H49_U23_MAX	H50_U23 H50_U23_MAX
H2_U31 H2_U31_MAX	H3_U31 H3_U31_MAX	H4_U31 H4_U31_MAX	...	H48_U31 H48_U31_MAX	H49_U31 H49_U31_MAX	H50_U31 H50_U31_MAX
H2_I1 H2_I1_MAX	H3_I1 H3_I1_MAX	H4_I1 H4_I1_MAX	...	H48_I1 H48_I1_MAX	H49_I1 H49_I1_MAX	H50_I1 H50_I1_MAX
H2_I2 H2_I2_MAX	H3_I2 H3_I2_MAX	H4_I2 H4_I2_MAX	...	H48_I2 H48_I2_MAX	H49_I2 H49_I2_MAX	H50_I2 H50_I2_MAX
H2_I3 H2_I3_MAX	H3_I3 H3_I3_MAX	H4_I3 H4_I3_MAX	...	H48_I3 H48_I3_MAX	H49_I3 H49_I3_MAX	H50_I3 H50_I3_MAX

B5 Display matrix 3-wire systems, unbalanced load, Aron

U12 U23 U31	U12_MAX U23_MAX U31_MAX	U12_MIN U23_MIN U31_MIN	DEV_UMAX DEV_UMAX_MAX			
UR1 UR2 U0	UNB_UR2_UR1 UNB_UR2_UR1_MAX					
I1 I2 I3	I1_MAX I2_MAX I3_MAX	IB1 IB2 IB3	IB1_MAX IB2_MAX IB3_MAX	DEV_IMAX DEV_IMAX_MAX		
P P_MAX						
Q Q_MAX						
S S_MAX						
PF PF_MIN_IN_L PF_MIN_IN_C	PF PF_MIN_OUT_L PF_MIN_OUT_C	PFG PFG_MIN_IN_L PFG_MIN_IN_C	PFG PFG_MIN_OUT_L PFG_MIN_OUT_C			
F_MAX F F_MIN						
P Q S	P U_MEAN I_MEAN	P Q PF	P S F	P QG TG		
D D_MAX	QG QG_MAX					
dd.mm hh.mm ss	OPR_CNTR1 OPR_CNTR2 OPR_CNTR3	OPR_CNTR				
THD_U12 THD_U12_MAX	THD_U23 THD_U23_MAX	THD_U31 THD_U31_MAX				
TDD_I1 TDD_I1_MAX	TDD_I2 TDD_I2_MAX	TDD_I3 TDD_I3_MAX				
Block with mean-values of power quantities						
H2_U12 H2_U12_MAX	H3_U12 H3_U12_MAX	H4_U12 H4_U12_MAX	...	H48_U12 H48_U12_MAX	H49_U12 H49_U12_MAX	H50_U12 H50_U12_MAX
H2_U23 H2_U23_MAX	H3_U23 H3_U23_MAX	H4_U23 H4_U23_MAX	...	H48_U23 H48_U23_MAX	H49_U23 H49_U23_MAX	H50_U23 H50_U23_MAX
H2_U31 H2_U31_MAX	H3_U31 H3_U31_MAX	H4_U31 H4_U31_MAX	...	H48_U31 H48_U31_MAX	H49_U31 H49_U31_MAX	H50_U31 H50_U31_MAX
H2_I1 H2_I1_MAX	H3_I1 H3_I1_MAX	H4_I1 H4_I1_MAX	...	H48_I1 H48_I1_MAX	H49_I1 H49_I1_MAX	H50_I1 H50_I1_MAX
H2_I2 H2_I2_MAX	H3_I2 H3_I2_MAX	H4_I2 H4_I2_MAX	...	H48_I2 H48_I2_MAX	H49_I2 H49_I2_MAX	H50_I2 H50_I2_MAX
H2_I3 H2_I3_MAX	H3_I3 H3_I3_MAX	H4_I3 H4_I3_MAX	...	H48_I3 H48_I3_MAX	H49_I3 H49_I3_MAX	H50_I3 H50_I3_MAX

B6 Display matrix 4-wire system, balanced load

U_MAX U U_MIN						
I I_MAX	IB IB_MAX					
P P_MAX						
Q Q_MAX						
S S_MAX						
PF PF_MIN_IN_L PF_MIN_IN_C	PF PF_MIN_OUT_L PF_MIN_OUT_C	PFG PFG_MIN_IN_L PFG_MIN_IN_C	PFG PFG_MIN_OUT_L PFG_MIN_OUT_C			
F_MAX F F_MIN						
P Q S	P U I	P Q PF	P S F	P QG TG		
D D_MAX	QG QG_MAX					
dd.mm hh.mm ss	OPR_CNTR1 OPR_CNTR2 OPR_CNTR3	OPR_CNTR				
THD_U THD_U_MAX						
TDD_I TDD_I_MAX						
Block with mean-values of power quantities						
H2_U H2_U_MAX	H3_U H3_U_MAX	H4_U H4_U_MAX	...	H48_U H48_U_MAX	H49_U H49_U_MAX	H50_U H50_U_MAX
H2_I H2_I_MAX	H3_I H3_I_MAX	H4_I H4_I_MAX	...	H48_I H48_I_MAX	H49_I H49_I_MAX	H50_I H50_I_MAX

B7 Display matrix 4-wire systems, unbalanced load

U1N	U1N_MAX	U1N_MIN	U12	U12_MAX	U12_MIN	UNE	DEV_UMAX
U2N	U2N_MAX	U2N_MIN	U23	U23_MAX	U23_MIN	UNE_MAX	DEV_UMAX_MAX
U3N	U3N_MAX	U3N_MIN	U31	U31_MAX	U31_MIN		
UR1	UNB_UR2_UR1						
UR2	UNB_UR2_UR1_MAX						
U0							
I1	I1_MAX	IB1	IB1_MAX	IN	DEV_IMAX		
I2	I2_MAX	IB2	IB2_MAX	IN_MAX	DEV_IMAX_MAX		
I3	I3_MAX	IB3	IB3_MAX				
IR1	UNB_IR2_IR1						
IR2	UNB_IR2_IR1_MAX						
I0							
P1	P1_MAX	P					
P2	P2_MAX	P_MAX					
P3	P3_MAX						
Q1	Q1_MAX	Q					
Q2	Q2_MAX	Q_MAX					
Q3	Q3_MAX						
S1	S1_MAX	S					
S2	S2_MAX	S_MAX					
S3	S3_MAX						
PF1	PF	PF	PFG1	PFG	PFG		
PF2	PF_MIN_IN_L	PF_MIN_OUT_L	PFG2	PFG_MIN_IN_L	PFG_MIN_OUT_L		
PF3	PF_MIN_IN_C	PF_MIN_OUT_C	PFG3	PFG_MIN_IN_C	PFG_MIN_OUT_C		
F_MAX							
F							
F_MIN							
P	P	P	P	P			
Q	U_MEAN	Q	S	QG			
S	I_MEAN	PF	F	TG			
P1	P2	P3	U1N	U2N	U3N		
Q1	Q2	Q3	I1	I2	I3		
S1	S2	S3	P1	P2	P3		
D1	D1_MAX	D	QG1	QG1_MAX	QG		
D2	D2_MAX	D_MAX	QG2	QG2_MAX	QG_MAX		
D3	D3_MAX		QG3	QG3_MAX			
dd.mm	OPR_CNTR1	OPR_CNTR					
hh.mm	OPR_CNTR2						
ss	OPR_CNTR3						
THD_U1N	THD_U2N	THD_U3N					
THD_U1N_MAX	THD_U2N_MAX	THD_U3N_MAX					
TDD_I1	TDD_I2	TDD_I3					
TDD_I1_MAX	TDD_I2_MAX	TDD_I3_MAX					
Block with mean-values of power quantities							
H2_U1N	H3_U1N	H4_U1N	...	H48_U1N	H49_U1N	H50_U1N	
H2_U1N_MAX	H3_U1N_MAX	H4_U1N_MAX		H48_U1N_MAX	H49_U1N_MAX	H50_U1N_MAX	
H2_U2N	H3_U2N	H4_U2N	...	H48_U2N	H49_U2N	H50_U2N	
H2_U2N_MAX	H3_U2N_MAX	H4_U2N_MAX		H48_U2N_MAX	H49_U2N_MAX	H50_U2N_MAX	
H2_U3N	H3_U3N	H4_U3N	...	H48_U3N	H49_U3N	H50_U3N	
H2_U3N_MAX	H3_U3N_MAX	H4_U3N_MAX		H48_U3N_MAX	H49_U3N_MAX	H50_U3N_MAX	
H2_I1	H3_I1	H4_I1	...	H48_I1	H49_I1	H50_I1	
H2_I1_MAX	H3_I1_MAX	H4_I1_MAX		H48_I1_MAX	H49_I1_MAX	H50_I1_MAX	
H2_I2	H3_I2	H4_I2	...	H48_I2	H49_I2	H50_I2	
H2_I2_MAX	H3_I2_MAX	H4_I2_MAX		H48_I2_MAX	H49_I2_MAX	H50_I2_MAX	
H2_I3	H3_I3	H4_I3	...	H48_I3	H49_I3	H50_I3	
H2_I3_MAX	H3_I3_MAX	H4_I3_MAX		H48_I3_MAX	H49_I3_MAX	H50_I3_MAX	

B8 Display matrix 4-wire system, unbalanced load, Open-Y

U1N	U1N_MAX	U1N_MIN	U12	U12_MAX	U12_MIN	
U2N	U2N_MAX	U2N_MIN	U23	U23_MAX	U23_MIN	
U3N	U3N_MAX	U3N_MIN	U31	U31_MAX	U31_MIN	
I1	I1_MAX	IB1	IB1_MAX	IN	DEV_IMAX	
I2	I2_MAX	IB2	IB2_MAX	IN_MAX	DEV_IMAX_MAX	
I3	I3_MAX	IB3	IB3_MAX			
IR1	UNB_IR2_IR1					
IR2	UNB_IR2_IR1_MAX					
I0						
P1	P1_MAX	P				
P2	P2_MAX	P_MAX				
P3	P3_MAX					
Q1	Q1_MAX	Q				
Q2	Q2_MAX	Q_MAX				
Q3	Q3_MAX					
S1	S1_MAX	S				
S2	S2_MAX	S_MAX				
S3	S3_MAX					
PF1	PF	PF	PFG1	PFG	PFG	
PF2	PF_MIN_IN_L	PF_MIN_OUT_L	PFG2	PFG_MIN_IN_L	PFG_MIN_OUT_L	
PF3	PF_MIN_IN_C	PF_MIN_OUT_C	PFG3	PFG_MIN_IN_C	PFG_MIN_OUT_C	
F_MAX						
F						
F_MIN						
P	P	P	P	P		
Q	U_MEAN	Q	S	QG		
S	I_MEAN	PF	F	TG		
P1	P2	P3	U1N	U2N	U3N	
Q1	Q2	Q3	I1	I2	I3	
S1	S2	S3	P1	P2	P3	
D1	D1_MAX	D	QG1	QG1_MAX	QG	
D2	D2_MAX	D_MAX	QG2	QG2_MAX	QG_MAX	
D3	D3_MAX		QG3	QG3_MAX		
dd.mm	OPR_CNTR1	OPR_CNTR				
hh.mm	OPR_CNTR2					
ss	OPR_CNTR3					
THD_U1N	THD_U2N	THD_U3N				
THD_U1N_MAX	THD_U2N_MAX	THD_U3N_MAX				
TDD_I1	TDD_I2	TDD_I3				
TDD_I1_MAX	TDD_I2_MAX	TDD_I3_MAX				
Block with mean-values of power quantities						
H2_U1N	H3_U1N	H4_U1N	...	H48_U1N	H49_U1N	H50_U1N
H2_U1N_MAX	H3_U1N_MAX	H4_U1N_MAX		H48_U1N_MAX	H49_U1N_MAX	H50_U1N_MAX
H2_U2N	H3_U2N	H4_U2N	...	H48_U2N	H49_U2N	H50_U2N
H2_U2N_MAX	H3_U2N_MAX	H4_U2N_MAX		H48_U2N_MAX	H49_U2N_MAX	H50_U2N_MAX
H2_U3N	H3_U3N	H4_U3N	...	H48_U3N	H49_U3N	H50_U3N
H2_U3N_MAX	H3_U3N_MAX	H4_U3N_MAX		H48_U3N_MAX	H49_U3N_MAX	H50_U3N_MAX
H2_I1	H3_I1	H4_I1	...	H48_I1	H49_I1	H50_I1
H2_I1_MAX	H3_I1_MAX	H4_I1_MAX		H48_I1_MAX	H49_I1_MAX	H50_I1_MAX
H2_I2	H3_I2	H4_I2	...	H48_I2	H49_I2	H50_I2
H2_I2_MAX	H3_I2_MAX	H4_I2_MAX		H48_I2_MAX	H49_I2_MAX	H50_I2_MAX
H2_I3	H3_I3	H4_I3	...	H48_I3	H49_I3	H50_I3
H2_I3_MAX	H3_I3_MAX	H4_I3_MAX		H48_I3_MAX	H49_I3_MAX	H50_I3_MAX

B9 Display matrix of mean-values of power quantities

TREND	MIN / MAX	Present	Present - 1	Present - 2	Present - 3	Present - 4
TR_PIN	M_PIN_MAX M_PIN_MIN	M1_PIN	M2_PIN	M3_PIN	M4_PIN	M5_PIN
TR_POUT	M_POUT_MAX M_POUT_MIN	M1_POUT	M2_POUT	M3_POUT	M4_POUT	M5_POUT
TR_QIN	M_QIN_MAX M_QIN_MIN	M1_QIN	M2_QIN	M3_QIN	M4_QIN	M5_QIN
TR_QOUT	M_QOUT_MAX M_QOUT_MIN	M1_QOUT	M2_QOUT	M3_QOUT	M4_QOUT	M5_QOUT
TR_QIND	M_QIND_MAX M_QIND_MIN	M1_QIND	M2_QIND	M3_QIND	M4_QIND	M5_QIND
TR_QCAP	M_QCAP_MAX M_QCAP_MIN	M1_QCAP	M2_QCAP	M3_QCAP	M4_QCAP	M5_QCAP
TR_S	M_S_MAX M_S_MIN	M1_S	M2_S	M3_S	M4_S	M5_S

C FCC statement

The following statement applies to the products covered in this manual, unless otherwise specified herein. The statement for other products will appear in the accompanying documentation.

NOTE: This equipment has been tested and found to comply with the limits for a Class A digital device, pursuant to Part 15 of the FCC Rules and meets all requirements of the Canadian Interference-Causing Equipment Standard ICES-003 for digital apparatus. These limits are designed to provide reasonable protection against harmful interference in a residential installation. This equipment generates, uses, and can radiate radio frequency energy and, if not installed and used in accordance with the instructions, may cause harmful interference to radio communications. However, there is no guarantee that interference will not occur in a particular installation. If this equipment does cause harmful interference to radio or television reception, which can be determined by turning the equipment off and on, the user is encouraged to try to correct the interference by one or more of the following measures:

- Reorient or relocate the receiving antenna.
- Increase the separation between the equipment and receiver.
- Connect the equipment into an outlet on a circuit different from that to which the receiver is connected.
- Consult the dealer or an experienced radio/T.V. technician for help.

Camille Bauer AG is not responsible for any radio television interference caused by unauthorized modifications of this equipment or the substitution or attachment of connecting cables and equipment other than those specified by Camille Bauer AG. The correction of interference caused by such unauthorized modification, substitution or attachment will be the responsibility of the user.

INDEX

A

Acknowledgment of alarms	44
Alarm handling	43
Alarming	
Acknowledgment	8
concept	8
reset	8
Auto-scaling	7

C

Commissioning	27
Configuration	
Ethernet Modbus/TCP	48
menu	46
Profibus DP	48

D

Data logger	52
activation	52
analysis	53
Device overview	6
Dimensional drawings	
with display	60
without display	61
Display brightness	38
Display elements	36
Display matrices	71
Display modes	
FULL	39
LOOP	41
REDUCED	40
USER	41
Driving a counter mechanism	24

E

Electrical connections	
analog outputs	25
Aron connection	19
cross sections	16
digital input	23
digital output	24

inputs	17
Modbus interface	25
Open-Y	20
power supply	22
Profibus DP	26
relays	22
Rogowski current inputs	21
split phase	21
Ethernet	30
LEDs	30
Network installation	31

F

Firewall	33
--------------------	----

I

Installation check	29
------------------------------	----

L

Limit values	11
dynamical monitoring	7
Logic components	
AND	10
NAND	10
NOR	10
OR	10
XNOR	10
XOR	10

M

Measured quantities	62
Basic measurements	62
earth fault monitoring	64
harmonic analysis	65
mean values and trend	69
meters	70
power factors	63
reactive power	67
system imbalance	66
zero displacement voltage	64
Measurement	
continuous	7

Measurements	
reset.....	45
Mechanical mounting .	14
Menu.....	46
Meter	
reset.....	45
Meter reading.....	42
Metering.....	7
Modbus image .	13
Modes of operation .	7
Monitoring.....	8
Mounting.....	14

N

NTP	33
-----------	----

O

operating elements .	36
operating hour counters .	11
Operating modes .	37

P

Profibus DP	
configuration .	48
installation.....	34
LED's	26

R

Resetting of measurements .	45
-----------------------------	----

S

Scope of supply .	5
SD-Card.....	52
access.....	53
changing	52
LED.....	52
Security notes	6
Service and maintenance.	54
Software	
CB-Analyzer .	53
CB-Manager .	27
online / offline .	29
operating	28
security system .	35
Simulation of I/O's .	29
Symmetrical components.	66

T

TCP ports.....	33
Technical data.	55
Time and date.	50
Time synchronization .	33

U

UTC	50
-----------	----

Z

Zero suppression .	56
--------------------	----

По вопросам продажи и поддержки обращайтесь:

Архангельск (8182)63-90-72
Астана (7172)727-132
Астрахань (8512)99-46-04
Барнаул (3852)73-04-60
Белгород (4722)40-23-64
Брянск (4832)59-03-52
Владивосток (423)249-28-31
Волгоград (844)278-03-48
Вологда (8172)26-41-59
Воронеж (473)204-51-73
Екатеринбург (343)384-55-89
Иваново (4932)77-34-06
Ижевск (3412)26-03-58
Казань (843)206-01-48

Калининград (4012)72-03-81
Калуга (4842)92-23-67
Кемерово (3842)65-04-62
Киров (8332)68-02-04
Краснодар (861)203-40-90
Красноярск (391)204-63-61
Курск (4712)77-13-04
Липецк (4742)52-20-81
Магнитогорск (3519)55-03-13
Москва (495)268-04-70
Мурманск (8152)59-64-93
Набережные Челны (8552)20-53-41
Нижний Новгород (831)429-08-12
Новокузнецк (3843)20-46-81

Новосибирск (383)227-86-73
Омск (3812)21-46-40
Орел (4862)44-53-42
Оренбург (3532)37-68-04
Пенза (8412)22-31-16
Пермь (342)205-81-47
Ростов-на-Дону (863)308-18-15
Рязань (4912)46-61-64
Самара (846)206-03-16
Санкт-Петербург (812)309-46-40
Саратов (845)249-38-78
Севастополь (8692)22-31-93
Симферополь (3652)67-13-56
Смоленск (4812)29-41-54

Сочи (862)225-72-31
Ставрополь (8652)20-65-13
Сургут (3462)77-98-35
Тверь (4822)63-31-35
Томск (3822)98-41-53
Тула (4872)74-02-29
Тюмень (3452)66-21-18
Ульяновск (8422)24-23-59
Уфа (347)229-48-12
Хабаровск (4212)92-98-04
Челябинск (351)202-03-61
Череповец (8202)49-02-64
Ярославль (4852)69-52-93

Единый адрес для всех регионов: cmn@nt-rt.ru || www.camille-bauer.nt-rt.ru

PROCESS CONTROL ENGINEERING



ANGULAR POSITION ENGINEERING



HEAVY CURRENT ENGINEERING

